

Oil spill response field manual



ExxonMobil

Metric Conversion Factors

Volume	Flow Rate
1 cm ³ = 1 ml = .001 L 1 L = 1 dm ³ = .001 m ³ 1 L = 0.264 Gallon Liquid US 1 m ³ = 6.29 API bbl	1 L/min = 0.0167 L/sec = 60 L/hr = 1440 L/day 1 L/min = 0.06 m ³ /hr 1 L/min = 0.265 gpm (US) 1 L/min = 9.05 API bbl/day
Length	Velocity
1 m = 10 ⁻³ km = 10 ² cm = 10 ³ mm = 10 ⁶ μ 1 cm = 0.3937 in 1 m = 3.2808 ft = 39.37 in 1 m = 0.5468 fathom 1 km = 0.62 mile = 3273 ft 1 km = 0.54 nautical mile (NM)	1 cm/sec = 10 ⁻² m/sec = 36 m/hr = 0.036 km/hr 1 m/sec = 1.94 knots (US) 1 km/hr = 0.54 knots (US) 1 km/hr = 0.621 mph (US)
Area	Mass/Weight
1 hectare = 10,000 m ² = 0.01 km ² 1 m ² = 10.76 ft ² = 1.196 yd ² 1 hectare = 2.471 acres = 0.00386 sq mile	1g = 10 ⁻³ kg = 10 ³ mg 1 metric tonne = 1000 kg 1 kg = 2.21 lbs = 0.0685 slug
Surface Tension	Force
1 kg-f/m = 9.807 N/m = 9807 dyne/cm 1 kg-f/m = 0.672 lbs/ft = 5.61 lb/in 1 N/m = 0.0685 lb/ft 1 N/mm = 5.64 lb/in	1 newton (N) = 10 ⁵ dyne 1 newton = 0.102 kg-f 1 newton = 0.2248 lb 1 newton = 7.233 pdl
Pressure	Application Rates
1 N/m ² = 0.102 kg-f/m ² = 1 pascal (Pa) 1 bar = 10 ⁶ dyne/cm ² = 0.1MPa 1 mm Hg = 133 Pa 1 Pa = 1.450 x 10 ⁻⁴ psi 1 kg-f/m ² = 0.0206 lb/ft ² 1 MPa = 9.869 atm	1 L/m ² = thickness in mm 1 L/hectare = 0.1 m ³ /km ² 1 L/hectare = 0.1068 gal/acre 1 tonne/hectare = 2.5 bbl/acre
Miscellaneous	
1 tonne of oil = 1000 L = 1 m ³ = 264.2 gal storage volume for boom, volume/length: ft ³ /ft x 0.093 = m ³ /m mg/L = parts per million (ppm) = % x 10 ⁻² x 10 ⁶ = ppm ice density = 0.8 g/cm ³ = 800 kg/m ³ viscosity in centipoise (cp) = viscosity in centistokes (cSt) x density temperature centigrade = (temperature Fahrenheit - 32) x 0.555	





**Oil Spill Response
Field Manual**

Revised 2014

Copyright © 2014, ExxonMobil Research and Engineering Company,

All Rights Reserved, Printed in USA.

In grateful recognition of years of service to the petroleum industry through tireless efforts to improve response technology and minimize environmental impacts, this Edition of the *ExxonMobil Oil Spill Response Field Manual* is dedicated to all the ExxonMobil employees, consultants, and government officials, who have contributed to this document over the past 30 years.

Acknowledgements

ACKNOWLEDGEMENTS

ExxonMobil acknowledges the services of employees, peers and government officials, and contractors who helped make this Field Manual a success. Those who have contributed to the preparation of this edition are noted below.

Current Edition (2014, English)

Thomas Coolbaugh/EMRE – Dispersants

Will Darbonne/EMIT – communications

Erik DeMicco/EMRE – technical input, project manager

Paul Foley/OSRL – communications

Rusty Freeman/EMIT – communications

Anita George-Ares/EMBSSI, now retired – Oiled Wildlife

Russ Hayward/ExxonMobil Corporation – industrial hygiene

Brian Higgins/USCG – communications

John Hoban/EMES – Waste Management

Daniel Kagan/EMIT – communications

Wolfgang Konkel/EMBSSI – technical input esp. Introduction and
Surveillance and Tracking

Alex Leonard/OSRL – communications

Luke Morgan/EMIT – communications

Tim Nedwed/URC – review of Dispersants, In Situ Burning

Andy Nicoll/OSRL – Waste Management

David Palandro/URC – review of Surveillance/Tracking

Robert Pond/USCG – Waste Management

Walter Putman/Marine Pollution Control – Waste Management

Jennifer Sheffer/EM – Industrial Hygiene

Alexis Steen/EMRE – technical input, ISB, and project manager

Dave Sweeten/BP – Waste Management

Robert Williams/EM Aviation – input on Aviation

Richard Woods/EMBSSI – review of Oiled Wildlife

Johnnie Young/EMIT – communications

Michael Ziccardi/UCDavis – technical input on Oiled Wildlife

HBP – printing and reproduction

Previous Editions

Contributors to Previous Editions (1984, 1992, 2000, 2002, 2005, and 2008)

Vitaly Aizenberg/EMBSI
Alan Allen/Spiltec
Christine Borgfeldt/EPR
Steven Bower/EMBSI
Jean Bruney/EPR
Andrie Chen/EPR
Jim Clark/EMRE
Tom Cook/EPR
Joe Czarnecki/EMRE
Bill Dahl/EMRE
Rob Dragnich/Alaska Interest
Bob Fiocco/EMRE
Stuart Gair/OSRL
Linda Garner/EM
Anita George-Ares/EMBSI
Ronald Goodman/Imperial Oil
Bob Goodrich/EMRE
Dave Goodridge/Esso Petroleum
Mark Gregory/USCG
Russ Hayward/Exxon Mobil Corporation
Peter Jensen/L&S
Mike Jolly/USCG
Wolfgang Konkel/EBSI
Bill Lerch/R&S
Dick Lessard/EMRE
Tommy Mahon/EM Baton Rouge Refinery
Robert Major/EPR
Tosh Moller/ITOPF
Rebecca Moore/EPR
Ken Motolenich-Salas/EMRE
Jessica Nacheman/EMRE
Tim Nedwed/URC

Jere Noerager/EPR
Doug O'Donovan/MSRC
Charlene Owens/URC
Ed Owens/OCC
Skip Przelomski/Clean Caribbean & Americas
David Salt/OSRL
Robert Schulze/consultant
Joe Smith/EPR
Laurence Solsberg/Counterspil Research Inc.
Nina Springer/EPR
Bob Steele/EPR
Alexis Steen/EMRE
Elliott Taylor/POLARIS
Evan Thayer/EMBSI
David Tilden/Environment Canada
Tommy Tomblin/EM Baytown Refinery
Mark West/Counterspil Research Inc.
Bob Williams/EPR
Don Wood/EPR

Contributor's organization pertained to the time when support was provided.



RESTRICTION TO USE

Material may be copied in whole or in part without the express authorization of ExxonMobil provided that: (1) the user includes ExxonMobil's copyright notice on all copies, (2) the materials are in no way modified or used in any misleading or inappropriate manner, and (3) the materials are not sold or in any way exploited.

Table of Contents

1. Introduction	1-1
1.1 Introduction	1-2
1.2 Organization of Manual	1-2
1.3 Response Priorities	1-4
1.4 Three-Tiered Response Consideration	1-5
1.5 Personnel Requirements	1-7
1.6 Critical Spill/Environmental Information	1-10
1.7 Oil Spill Volume	1-15
1.8 Oil Characteristics and Behavior	1-16
1.9 Limiting Access	1-18
1.10 Net Environmental Benefit Analysis	1-19
2. Safety and Health	2-1
2.1 Introduction	2-2
2.1.1 Basic Safety Rules	2-2
2.1.2 The Buddy System	2-3
2.1.3 Hand or Whole Body Communication Signals	2-3
2.2 Risks	2-4
2.2.1 Fire and Explosions	2-4
2.2.2 Hazardous Atmospheres/Hazardous Chemicals	2-6
2.2.2.1 Benzene	2-10
2.2.2.2 2-Butoxyethanol	2-10
2.2.2.3 Carbon Monoxide	2-10
2.2.2.4 Gasoline	2-11
2.2.2.5 Heavy Hydrocarbon Products	2-11
2.2.2.6 Hydrogen Sulfide (H ₂ S)	2-12
2.2.2.7 Middle Distillate Products	2-12
2.2.2.8 Oxygen	2-13
2.2.2.9 Overall Guidance	2-13
2.2.3 Heat and Cold	2-14
2.2.3.1 Heat Stress (Hyperthermia)	2-14
2.2.3.2 Cold Stress (Hypothermia)	2-14
2.2.4 Site Conditions	2-17
2.2.5 Miscellaneous Hazards	2-17
2.2.5.1 Noise	2-17
2.2.5.2 Other Hazards	2-17

2.3	Protective Equipment	2-18
2.3.1	Protective Clothing	2-18
	2.3.1.1 Splash Potential Only	2-18
	2.3.1.2 Hydrocarbon Immersion Potential	2-18
2.3.2	Respiratory Protection	2-19
2.3.3	Confined Space Entry	2-20
2.4	Personal Health	2-20
2.5	Transportation Safety	2-21
2.5.1	Small Boat Safety Rules	2-21
2.5.2	Aircraft Safety Rules	2-22
2.6	Decontamination	2-22
3.	Logistics and Communications	3-1
3.1	Introduction	3-2
3.2	Logistics	3-2
3.2.1	Resources	3-3
	3.2.1.1 Contracts	3-3
	3.2.1.2 Procurement	3-4
	3.2.1.3 Shipping/Receiving	3-4
	3.2.1.4 Warehouse/Staging	3-4
	3.2.1.5 Inventory Management	3-4
	3.2.1.6 Equipment Tracking	3-4
3.2.2	Support	3-5
	3.2.2.1 Transportation	3-5
	3.2.2.2 Provisioning	3-5
	3.2.2.3 Permits	3-6
	3.2.2.4 Waste Management	3-6
	3.2.2.5 Assembly, Fabrication, and Maintenance	3-6
	3.2.2.6 Demobilization	3-6
	3.2.2.7 Decontamination	3-7
3.2.3	Services	3-7
	3.2.3.1 Security	3-7
	3.2.3.2 Facilities	3-8
	3.2.3.3 Administration	3-8
3.3	Communications	3-8
3.3.1	Common Operating Picture (COP)	3-11
4.	Surveillance and Tracking	4-1
4.1	Introduction	4-2
4.2	Oil Properties and Fate	4-4
4.2.1	API Gravity	4-4
4.2.2	Flash Point	4-4

4.2.3	Lower Explosion Limit	4-4
4.2.4	Viscosity	4-5
4.2.5	Wax Content	4-5
4.2.6	Pour Point	4-5
4.2.7	Solubility	4-5
4.2.8	Specific Gravity (Liquid)	4-5
4.2.9	Specific Gravity (Vapor)	4-5
4.3	Forecasting Slick Drift	4-6
4.4	Estimating Slick Volumes	4-7
4.5	Visual Observation and Photography	4-7
4.6	Tracking Buoys	4-8
4.7	Remote Sensing	4-8
4.7.1	Infrared Sensors	4-8
4.7.2	Ultraviolet Sensors	4-9
4.7.3	Laser Fluorosensors	4-9
4.7.4	Radar	4-9
4.7.5	Satellite Remote Sensing	4-10
4.7.6	Surveillance and Tracking of Subsea Oil	4-10
4.7.7	Surveillance and Tracking of Oil under Ice and Snow	4-10
4.8	Material Take Off (MTO) List	4-11
5.	Boom	5-1
5.1	Introduction	5-2
5.2	Boom Components and Fittings	5-3
5.3	Operational Factors	5-5
5.3.1	Roll Stiffness	5-5
5.3.2	Heave Response	5-5
5.3.3	Freeboard and Skirt	5-5
5.3.4	Tensile Strength and Puncture Resistance	5-5
5.3.5	Ease of Storage and Deployment	5-6
5.3.6	Other Features	5-6
5.4	Boom Failure	5-7
5.4.1	Entrainment Failure	5-7
5.4.2	Drainage Failure	5-8
5.4.3	Splashover Failure	5-8
5.4.4	Submergence Failure	5-9
5.4.5	Planing Failure	5-9
5.5	Boom Application	5-10
5.6	Boom Selection	5-11

5.7	Types of Boom	5-13
5.7.1	Internal Foam Flotation Boom	5-14
	5.7.1.1 General Comments	5-15
	5.7.1.2 Recommended Use	5-15
	5.7.1.3 Operational Considerations	5-15
5.7.2	Self-Inflating Boom	5-16
	5.7.2.1 General Comments	5-17
	5.7.2.2 Recommended Use	5-17
	5.7.2.3 Operational Considerations	5-17
5.7.3	Pressure-Inflatable Boom	5-18
	5.7.3.1 General Comments	5-19
	5.7.3.2 Recommended Use	5-19
	5.7.3.3 Operational Considerations	5-19
5.7.4	Fence Boom	5-20
	5.7.4.1 General Comments	5-21
	5.7.4.2 Recommended Use	5-21
	5.7.4.3 Operational Considerations	5-21
5.8	Boom Deployment	5-22
5.8.1	BoomVane™	5-23
5.9	Guidelines for Towing Boom	5-24
5.9.1	U-booming	5-24
5.9.2	V-booming	5-24
5.9.3	J-booming	5-24
5.10	Special Application Boom	5-26
5.10.1	Shore-Sealing Boom	5-26
5.10.2	Netting Boom	5-26
5.10.3	Current Buster® Technology	5-27
5.11	Boom Anchoring	5-28
5.11.1	Anchoring in Marine Waters	5-29
5.11.2	Anchors of Opportunity	5-30
5.11.3	Anchoring in Currents	5-30
5.12	Boom Washing	5-31
5.13	Material Take Off (MTO) List	5-32
6.	Shoreline Protection	6-1
6.1	Introduction	6-2
6.2	Shoreline Types	6-2
6.3	Selection of Shoreline Protection Techniques	6-5
6.4	Shoreline Protection Decision Guides	6-6

6.5	Specific Protection Measures	6-8
6.5.1	Exclusion Booming	6-8
6.5.2	Diversion Booming	6-9
6.5.3	River Booming	6-10
6.5.4	Shore-Sealing Boom	6-10
6.5.5	Beach Berms	6-11
6.5.6	Berms, Dams, and Inverted Weir on Streams	6-12
6.5.7	Passive Sorbents	6-13
6.6	Material Take Off (MTO) List	6-14
7.	Dispersants	7-1
7.1	Introduction	7-2
7.2	Suggested Dispersants	7-4
7.3	Dispersant Use Near Sensitive Habitats	7-5
7.3.1	Kelp Beds	7-5
7.3.2	Seagrass Beds	7-5
7.3.3	Coral Reefs and Lagoons	7-5
7.3.4	Nearshore Sub-Tidal Zones	7-5
7.3.5	Tidal Flats	7-6
7.3.6	Salt Marshes	7-6
7.3.7	Mangroves	7-6
7.3.8	Other Considerations—Marine Birds and Mammals	7-6
7.4	Dispersant Dosage	7-6
7.5	Dispersant Application Techniques	7-8
7.5.1	Vessel Application Systems	7-10
7.5.1.1	Vessels with Spray Arm Booms	7-10
7.5.1.2	Vessels with Fire Monitors or Other Single Point Spray Systems	7-11
7.5.2	Aircraft Application	7-12
7.6	Material Take Off (MTO) List	7-17
8.	In-Situ Burning	8-1
8.1	Introduction	8-2
8.1.1	Regulatory Approval	8-2
8.2	Basics of In-Situ Burning	8-3
8.2.1	Basic Requirements of In-situ Burning	8-3
8.2.2	Efficiency of In-situ Burning	8-4
8.2.3	On-Water Conditions and Weathering	8-5
8.2.4	Recovery of Residue	8-5

8.3	Burning Equipment	8-6
8.3.1	Fire-Resistant Boom	8-6
8.3.2	Igniters	8-6
8.3.3	Chemical Herders	8-7
8.4	Burning Operations	8-8
8.4.1	Inland or Upland Burning	8-8
8.4.2	Burning on Water	8-10
8.4.3	Burning and Wind	8-12
8.5	Material Take Off (MTO) List	8-13
9.	Skimmers	9-1
9.1	Introduction	9-2
9.2	Skimmer Selection Matrix	9-3
9.2.1	Skimmer Selection Example	9-7
9.3	Detailed Information on Skimmer Types	9-8
9.3.1	Simple Weir	9-8
9.3.2	Self-Leveling Weir	9-10
9.3.3	Weir with Integral Screw Auger	9-12
9.3.4	Advancing Weir	9-14
9.3.5	Weir Boom	9-16
9.3.6	Drum	9-18
9.3.7	Grooved Drum or Disc	9-20
9.3.8	Disc	9-22
9.3.9	Fabric-Coated Disc or Drum	9-24
9.3.10	Rope Mop	9-26
9.3.11	Zero Relative Velocity (ZRV) Rope Mop	9-28
9.3.12	Sorbent Lifting Belt	9-30
9.3.13	Brush	9-32
9.3.14	Water Jet	9-34
9.3.15	Submersion Plane/Belt	9-36
9.3.16	Rotating Vane	9-38
9.3.17	Paddle Belt	9-40
9.4	Material Take Off (MTO) List	9-42
10.	Sorbents	10-1
10.1	Introduction	10-2
10.2	Selection Criteria	10-2
10.2.1	Capacity	10-2
10.2.2	Rate of Sorption	10-3
10.2.3	Buoyancy	10-3
10.2.4	Oil Retention	10-3
10.2.5	Effect of Dispersants	10-3

10.2.6	Suitable Uses	10-3
10.2.7	Reusability	10-3
10.2.8	Ease of Retrieval	10-4
10.2.9	Biodegradability	10-4
10.2.10	Disposal	10-4
10.3	Types of Sorbents	10-6
10.4	Application	10-7
10.5	Solidifiers	10-9
11.	Transfer Systems	11-1
11.1	Introduction	11-2
11.2	Pump Selection Matrix	11-3
11.2.1	Pump Selection Example	11-4
11.3	Detailed Information on Pump Types	11-6
11.3.1	Centrifugal Pump	11-6
11.3.2	Lobe Pump	11-7
11.3.3	Gear Pump	11-8
11.3.4	Intermeshing Screw Pump	11-9
11.3.5	Rotary Vane Pump	11-10
11.3.6	Flexible Impeller Pump	11-11
11.3.7	Screw/Auger Pump	11-12
11.3.8	Progressive Cavity Pump	11-13
11.3.9	Reciprocating Pump	11-14
11.3.10	Diaphragm Pump	11-15
11.3.11	Peristaltic Pump	11-16
11.3.12	Annular Injection	11-17
11.4	Transport Vehicles	11-18
11.4.1	Vacuum Truck	11-18
11.4.2	Air Conveyor	11-19
11.4.3	Wheeled Vehicles	11-20
11.5	Material Take Off (MTO) List	11-21
12.	Shoreline Treatment	12-1
12.1	Introduction	12-2
12.2	Assessment of Shoreline Oiling	12-3
12.3	Shoreline Treatment Decision Guides	12-8
12.4	Treatment of Shoreline Types	12-13
12.5	Natural Recovery	12-24
12.6	Physical Treatment Techniques	12-25
12.7	Bioremediation	12-49
12.8	Chemical Treatment Methods	12-50

12.9	Inland Spills	12-51
12.9.1	Cleanup Strategies	12-51
12.10	Material Take Off (MTO) List	12-52
13.	Oiled Wildlife Response	13-1
13.1	Introduction	13-2
13.2	Key Considerations	13-2
13.3	Safety Guidelines	13-2
13.4	Wildlife Protection	13-3
13.5	Deterrence (Hazing)	13-5
13.6	Oiled Birds	13-7
13.7	Oiled Mammals	13-9
13.8	Oiled Reptiles and Amphibians	13-9
13.9	Wildlife Treatment	13-10
13.10	Material Take Off (MTO) List	13-11
14.	Waste Management	14-1
14.1	Introduction	14-2
14.2	Waste Management and Regulations	14-2
14.3	Storage Devices	14-4
14.4	Storage Selection Guides	14-7
14.5	Waste Stream Segregation and Minimization	14-22
14.5.1	Solid Wastes	14-23
14.5.2	Liquid Wastes	14-23
14.6	Disposal Methods	14-24
14.7	Transportation	14-30
14.8	Material Take Off (MTO) List	14-31
15.	Spill Response in Cold Regions	15-1
15.1	Introduction	15-2
15.2	Safety and Health Considerations	15-2
15.3	Effects of Low Temperature on Oil	15-3
15.4	Environmental Factors That Can Affect Cold Region Response	15-3
15.4.1	Positive Influences on Response	15-3
15.4.2	Negative Influences on Response	15-4
15.5	On Water Response Options	15-4
15.5.1	Open Water	15-5
15.5.1.1	Containment and Recovery	15-5
15.5.1.2	In-Situ Burning	15-5
15.5.1.3	Dispersants	15-5

15.5.2	Broken Ice	15-5
	15.5.2.1 Containment and Recovery	15-6
	15.5.2.2 In-Situ Burning	15-6
	15.5.2.3 Dispersants	15-6
15.5.3	Solid Ice Cover on Water	15-7
	15.5.3.1 Containment and Recovery	15-8
	15.5.3.2 In-Situ Burning	15-8
	15.5.3.3 Dispersants	15-8
15.6	On Land Response Options	15-9
15.7	Assessment, Mapping and Tracking	15-10
15.8	Cleaning of Oiled Shorelines	15-11
15.9	Response in Permafrost Habitats	15-12
16.	Aviation Support	16-1
16.1	Introduction	16-2
16.2	Use of Approved Aviation Contractors and Aircraft	16-2
16.3	Planning and Roles	16-3
	16.3.1 Basic Aviation Services Planning	16-3
	16.3.2 Aviation Support Roles	16-5
	16.3.2.1 Aviation Advisor or Air Operations Branch Director	16-5
	16.3.2.2 Local Aviation Contact	16-5
	16.3.2.3 Aerial Observer	16-5
	16.3.2.4 Spotter	16-6
16.4	Aviation Support	16-6
	16.4.1 Mechanical Recovery Operations	16-6
	16.4.2 Aviation Support of Surface Dispersant Operations	16-7
	16.4.3 Aviation Support for In-Situ Burn Operations	16-9
	16.4.3.1 Heli-Torch Operations	16-9
	References & Websites	Ref-1

1 Introduction

1

1.1 Introduction

This field manual is intended for use by responders at an oil spill. It is a collection of “Rules of Thumb” and checklists that provide quick access to the information needed when formulating response strategies.

The manual is neither an all-inclusive textbook nor a substitute for training, qualified technical advice, or common sense. It addresses response to oil spills that could reach water and those that occur on land. Legal issues and environmental regulations are likewise outside the scope of this manual.

This manual is not a statement of ExxonMobil policy. However, all operations, including selection of response strategies, access to shorelines, implementation of cleaning methods, etc., planned or conducted on behalf of ExxonMobil are to be in full compliance with applicable laws and regulations. Exxon Mobil Corporation, its affiliates, subsidiaries, employees, officers, directors, and contractors shall not be held liable for injury, loss, or damage incurred as the result of use of this manual by others.

Additionally, this manual remains a work in progress and ExxonMobil retains the right to modify the individual sections as it deems necessary. The manual is drafted in English. ExxonMobil bears no responsibility for misinterpretation or other distinctions resulting from translation.

ExxonMobil permits the use and modification of this manual provided that all modifications are clearly denoted and that the user/modifier acknowledges that ExxonMobil retains the right to use and copy all derivative works at its discretion. Proper acknowledgement of copyright ownership by ExxonMobil is required.

1.2 Organization of Manual

This introductory section explains the organization of the manual and discusses some general oil spill response principles.

The remainder of the manual is organized according to the sequence of events encountered in a well-organized oil spill response. Table 1-1 contains a brief description of each section and Table 1-2 lists the steps to be taken in a spill response and the corresponding manual sections. Each step involves either a direct action or an issue that can be resolved by an action that is described in the manual.

It is important to realize that oil spill response should be considered in terms of the total package or system and that the individual components of the system should be considered collectively rather than independently.

Table 1-1 Description of the Manual Contents

Section	Description of Contents
2	Provides health and safety precautions for those involved in responding to a spill.
3	Provides guidance on dealing with logistics and communication requirements.
4	Provides information on the fate of oil spills on water and provides recommendations for surveillance and tracking of slicks.
5	Provides performance information for selecting a type and size of boom for specific applications.
6	Provides techniques for protecting shorelines which are threatened but not yet impacted by an oil spill.
7	Provides information on the proper selection and use of chemical dispersants.
8	Provides information on removing oil by in-situ burning.
9	Discusses selection and use of skimmers as a tool for mechanical cleanup and recovery.
10	Discusses the selection and use of sorbent materials in oil spill cleanup operations.
11	Discusses the selection and use of transfer equipment.
12	Provides guidance on shoreline cleanup programs including the evaluation of the impact of the cleanup procedure and determination of the support needed for each cleanup technique.
13	Discusses wildlife rescue and rehabilitation, including oiled birds and mammals.
14	Discusses waste management alternatives including storage and disposal of oily water, debris, sorbent materials, cleaning gear, etc.
15	Discusses issues relevant to response in cold regions.
16	Provides general guidance on support that aerial assets can provide.
Ref	Provides a list of selected references for more detailed information.

Table 1-2 Spill Response Activities

Step	Activities	Section
1	Activate response operations: <ul style="list-style-type: none"> • Act safely • Plan logistics and communications 	2, 15 3
2	Obtain and assess incident data: <ul style="list-style-type: none"> • Spill location • Oil type and volume • Weather and sea conditions 	4, 16
3	Monitor the spill – conduct surveillance and tracking	4, 16
4	Contain and remove the oil: <ul style="list-style-type: none"> • Mechanical containment and recovery • Chemical dispersion • In-situ burning 	16 5, 9, 10, 11, 15 7, 15 8, 15
5	Protect threatened resources: <ul style="list-style-type: none"> • Shoreline • Wildlife 	6 13
6	Evaluate wildlife rehabilitation options	13
7	Conduct shoreline treatment	12, 15, 16
8	Finalize operations: <ul style="list-style-type: none"> • Dispose of wastes • Demobilize personnel and equipment 	14

1.3 Response Priorities

Response objectives, in general, are in the following order:

- Protecting the safety and health of responders and the public
- Reducing the impact to the environment
- Protecting property

Safety and health are the highest priorities.

The following factors should be considered:

- Fire and explosion potential of vapors at or near the spill site
- Potential adverse effects of the oil
- Safe handling of chemicals used in countermeasures
- Proper use of safety equipment
- Heat stress/stroke or hypothermia
- Small boat safety
- Helicopter and aircraft safety
- Management of volunteers

Speed is essential in recovery efforts.

- Oil spreads and drifts rapidly; containment and recovery will be more effective if carried out before oil spreads over wide areas.
- Evaporation rapidly increases oil viscosity.
- Chemical dispersants are more effective when oil is minimally weathered.
- Oil can be burned more readily when fresh.
- Sustained combustion requires at least 0.1 inch (2–3 mm) of slick thickness.

1.4 Three-Tiered Response Consideration

Although every spill is unique, the consideration of discharge volume, location, and possible impacts allows spill events to be categorized according to three tiers.

Table 1-3 Three-Tiered Response

Tier 1	Accidental discharges occurring at or near a vessel or facility as a result of disruption in routine operations. Impacts are low and in-house response capability is adequate.
Tier 2	Medium-size spills occurring within the vicinity of vessel or facility as a consequence of a non-routine event. Significant impacts are possible and external (regional) support for adequate spill response, e.g., assistance from a local spill cleanup co-operative, is required.
Tier 3	Large spills occurring either near or remote from a vessel or facility as a result of a non-routine event, requiring substantial resources and support from national or worldwide spill co-operatives to mitigate effects perceived to be wide-reaching, i.e., spills of national or international significance.

Examples of Tier 1 spills include:

- Overflow of sumps or oil-water separators
- Leakage or overflow of tanks
- Leakage from valves, pipelines or transfer hoses
- Accidental discharge of bilge water from vessels
- Tank truck/tank car rollover near water

Examples of Tier 2 and 3 spills include:

- Cargo loss due to tanker grounding, collision, or system failure
- Rupture of a sub-sea pipeline
- Spills due to fire or explosion at a terminal or on a tanker
- Spills due to sabotage, natural disaster, or blowout
- Tank collapse near water

The tiered response approach calls for the smallest spills to be handled using local resources and plans. Additional tiers are activated as the available operational capability is exceeded. A possible organizational structure for a Tier 2 response is shown in Figure 1-1. It should be noted that some countries follow a prescribed organizational structure such as the US Incident Command System (ICS). Figure 1-1, therefore, is presented as an example only.

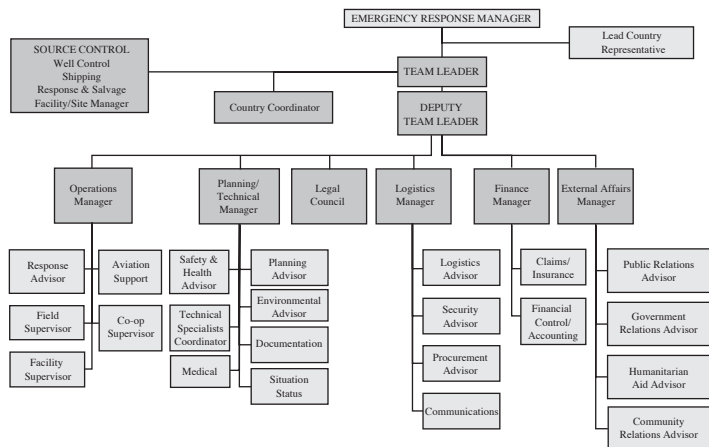

Figure 1-1 Example Organization Chart of a Spill Response Team

The amount and type of oil-impacted shorelines are the prime factors that determine personnel requirements.

Useful rules of thumb for planning response operations are:

- Land-based operations (cleanup of shoreline) are much more labor intensive than sea-based operations (booming and skimming, in situ burning, or dispersant application)
- Peak personnel needs may occur several weeks into the spill response
- Optimal field operations supervision ratios are 1 supervisor: 10 foremen: 100 workers
- Supervisors must be in direct communication with the Operations Manager or a designated assistant

Figures 1-2 through 1-6 illustrate personnel requirements and time required for historical clean-up operations. Shoreline impact has a sizable impact on the workforce.

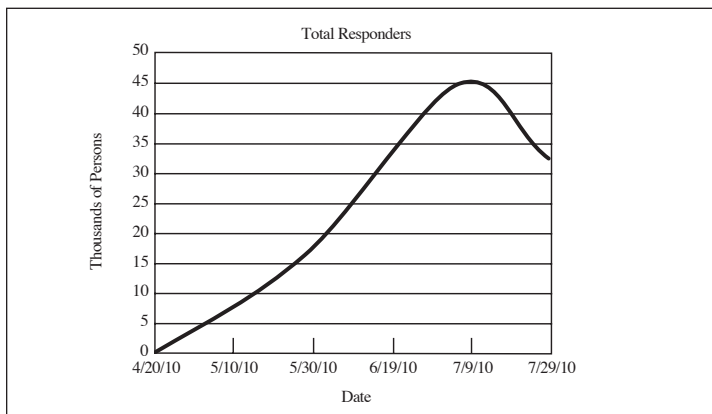

Figure 1-2 Total Responders Involved in **BP Macondo** Incident through July 2010

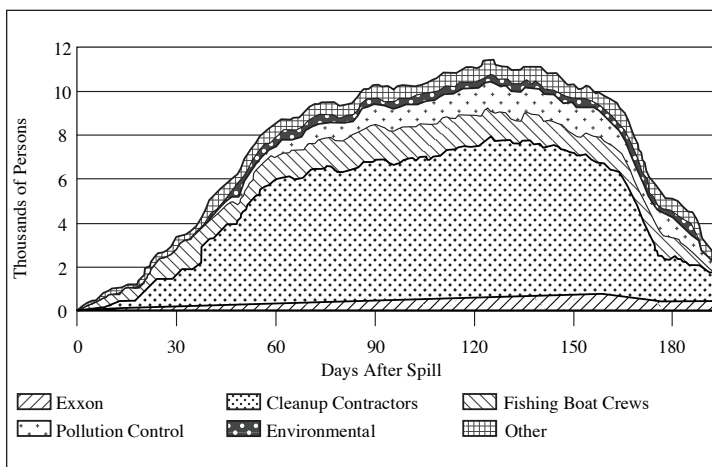

Figure 1-3 Personnel Involved in the *Exxon Valdez* Spill

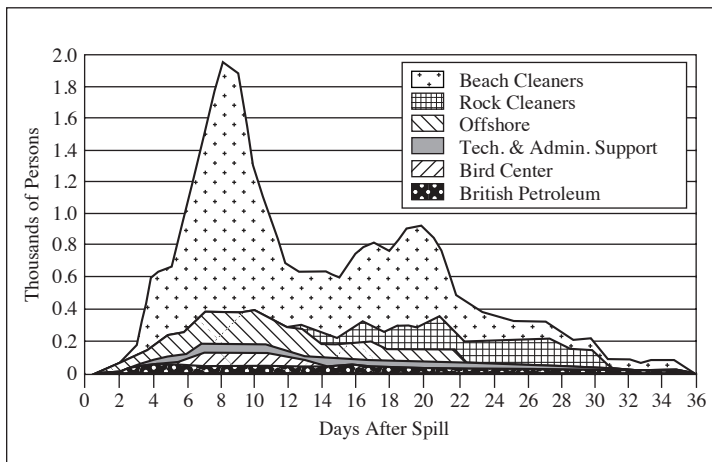

Figure 1-4 Personnel Involved in the *American Trader* Spill

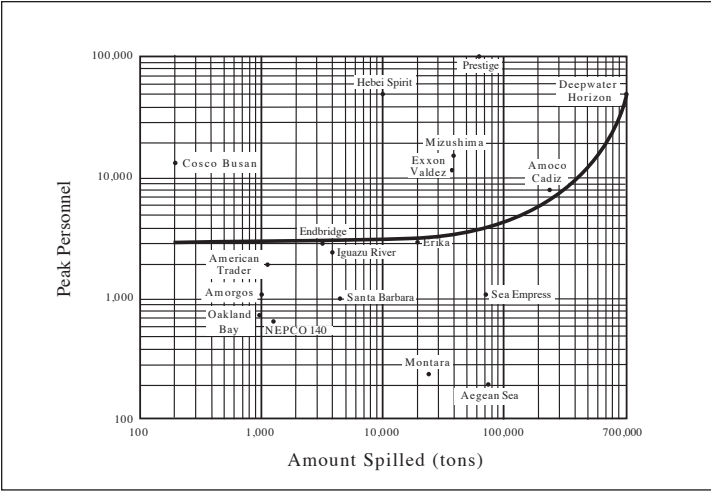

Figure 1-5 Peak Personnel Versus Amount Spilled

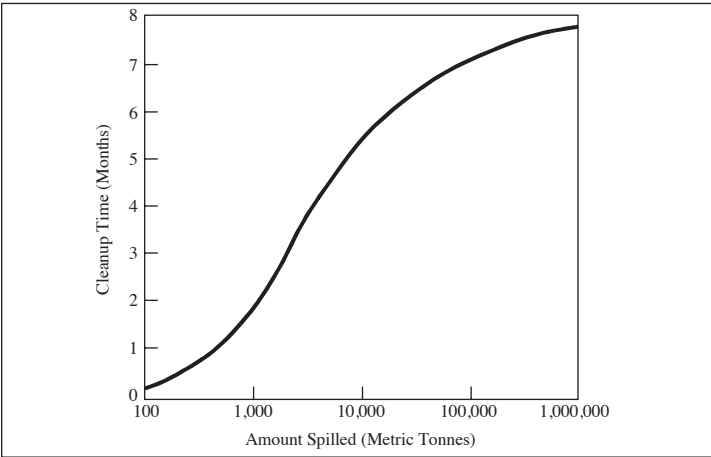

Figure 1-6 Spill Size Versus Duration of Cleanup

1.6 Critical Spill/Environmental Information

Once an oil spill has occurred, every attempt should be made to contain the spill immediately to prevent it from spreading. The most accurate information on the spill size, location, and environmental factors must be available to the on-scene management team.

The Oil Spill Data Log illustrated in Figure 1-7 is the primary source of information for predicting slick movement, behavior, and environmental impact.

The weather, oceanographic data, oil movement and impacts should be updated regularly.

- Report the logged information to the spill modeling team
- When specific information is not available, make a best estimate

OIL SPILL DATA LOG

Company: _____

Observer and Phone Number: _____

Date: _____ Time: _____

SPILL DATA

Crude or Product Type: _____

API Gravity: _____

Volume of Discharge: (est.) _____

Location of Initial Spill

- Latitude: _____ Longitude: _____

Direction of Slick Movement: _____

Size and Location of Slick(s): (Plot on Separate Sheets)

Apparent Source: _____

- Initial Time and Date: _____

Approximate Duration: _____

- Stationary _____ Moving _____
- Instantaneous _____ Continuous _____
- Estimated Flowrate If Continuous _____

Fire? Yes _____ No _____

Maximum Spill Potential: _____

METEOROLOGICAL DATA

Initial Wind: Speed _____ Direction From: _____

Air Temperature: _____ (°C or °F)

Precipitation: None _____ Rain _____ Snow _____

Visibility Estimate: Good _____ Fair _____ Poor _____

Forecast: _____

Source: (name, phone, address) _____

OCEANOGRAPHIC DATA

Water Current: Speed _____ Direction _____

Water Temperature: _____ (°C or °F)

Sea State: 1 _____ 2 _____ 3 _____ 4 _____ 5 _____

Tide Phase: Flood _____ High _____ Ebb _____

High Tide Time: _____

Source: _____

ADDITIONAL INFORMATION

Probable Coastal Impact Site:

Habitat: _____

Slick Thickness: Windrows _____ Patches _____

Other _____

Figure 1-7 Oil Spill Data Log

Figure 1-8 shows the relationship between wind and wave conditions in fully developed seas. Beaufort wind force scale and sea state are shown relative to wind speed and wave height.

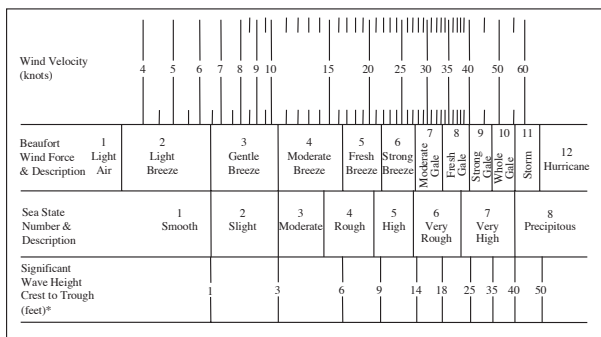

*The average height of the highest 1/3 of the waves, assuming 1000 mile (1600 km) fetch, 25-hour duration, Bretschneider Spectrum

*The average height of the highest 1/3 of the waves, assuming 1000 mile (1600 km) fetch, 25 hour duration, Bretschneider Spectrum

Figure 1-8 Related Wind and Wave Conditions in Fully Developed Seas

Oil spreading is complicated by the variability and interdependence of factors such as:

- Initial composition
- Weathering (includes the effects of evaporation, natural dispersion, and emulsification)
- Environmental conditions

Several oil spill models are available to predict the spreading of an oil slick, but good input data are necessary.

One algorithm used in several computerized models to describe the spreading was developed by Mackay et al. in 1980 (see References). The algorithm assumes the slick consists of a “thin” slick (i.e., sheen) and a thick slick, with the thick slick comprising about 90% of the total slick area. The thick slick feeds the thin slick at a rate dependent on empirically based constants. An average thickness of the thick part of a slick over a two day timeframe is plotted in Figure 1-9 for a medium crude in calm seas and low winds.

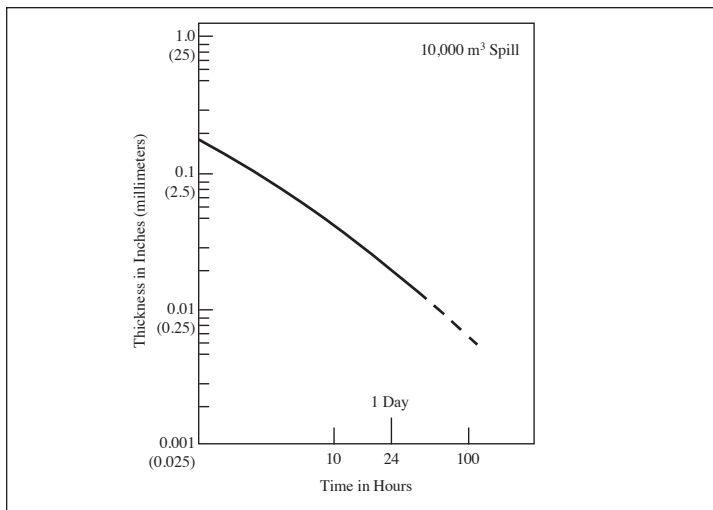

Figure 1-9 Behavior of the Thick Part of a Slick of Crude Oil on Water (Modified from Mackay et al., Oil Spill Processes and Models, University of Toronto. Figure 1-9 is based on the first 48 hours of concentric thick and thin slicks of medium crude under calm seas and low winds.)

Figure 1-9 is intended to only show the predicted trend of thickness in a hypothetical spill with time. In general, spill thickness varies within a slick (even in the thick portion of the slick) and is dependent on the volume of oil spilled, wind/wave/current conditions, type of oil spilled, and water temperature. At present there is no means for measuring spill thickness over a large area. The most common means of assessing slick thickness is by visual color comparison as shown in Figure 1-10. The figure allows a gross estimate of spill volume to be made from color and area covered. The method has high error and caution should be used in using this tool for estimating how much oil was spilled. Table 1-4 is an alternative guide. Different crudes or weathering may lead to deviations from these average predictions.

In forecasting oil slick movement on water and probable coastal impact sites, note the following:

- Oil spill modeling is preferred to manual calculations
- In the absence of a computer model, slick movement may be predicted by vector addition of the components due to wind and current

- Currents dominate slick movement when winds are light
- The wind-driven velocity component of a slick is about 3–5% of wind speed and in the same direction as the wind
- The current-driven velocity component of a slick is co-directional with the current and at the same speed
- Never accept predictions blindly. Always verify by aerial reconnaissance and ground truthing

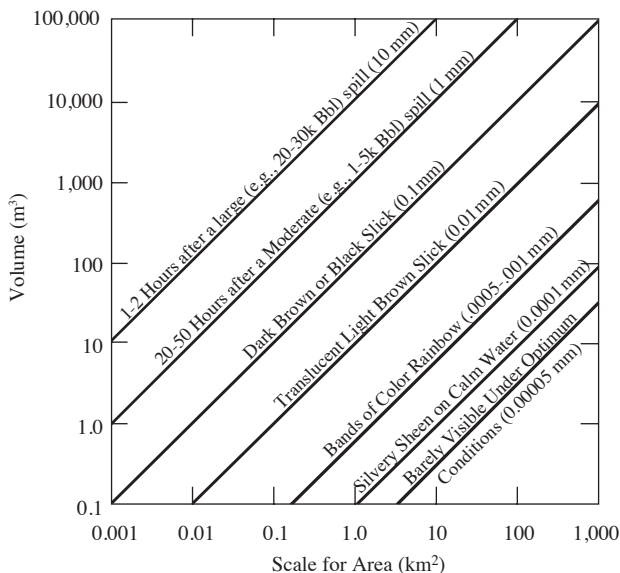

Conversion Factors

$$1 \text{ m}^3 = 6.25 \text{ Bbl}$$

Figure 1-10 Volume of a Slick of Crude Oil on Water

Table 1-4 Determining Amount of Oil Remaining by Appearance*

	Appearance/Approximate Thickness					
	Barely Discernible	Silvery Sheen	Rainbow Colors	Darkening Bands of Color	Dull Colors	Light Brown
Approximate Thickness (Microns)	0.05	0.1	0.5	1	3	10
Area (m ²)	Liters					
100	<.01	.01	.05	.1	.3	1
1,000	.05	.1	.5	1	3	10
5,000	.25	.5	2.5	5	1.5	50
10,000 (1 hectare)	.5	1	5	10	30	100
100,000	5	10	50	100	300	1000
500,000	25	50	250	500	1500	5000
1,000,000 (1 km ²)	50	100	500	1000	3000	10000
<p>* Based on numerous literature sources. 1000 microns = 1 millimeter; 1 micron thick is equivalent to 1 m³ / km² Note: Area of a spill is arrived at by multiplying the estimated length of the spill by estimated width. Examples: 1000 m x 1000 m = 1 km²</p>						

1.7 Oil Spill Volume

Estimates of oil volume obtained from the color and size of a slick on water (see Figure 1-10 and Table 1-4) have large uncertainties associated with them due to:

- Variable oil properties
- The complexity of the slick geometry (spatial and temporal variability)
- Meteorological conditions
- Sea state
- Weathering
- Physical/chemical processes occurring within the slick

The thicknesses reported in Table 1-4 represent averages reported in the literature. For each of the appearance categories, a wide range of thicknesses has been reported, up to an order of magnitude different, as summarized in Table 1-5. The Bonn Agreement Oil Appearance Code, summarized in Table 1-5, is another way to estimate slick thickness and volume. A more detailed description of the Oil Appearance Code is provided in the 2009 Bonn Agreement Aerial Operations Handbook. These thicknesses should not be used for estimating the amount spilled except for very coarse estimates. This is especially true for spills that have been on water for some period of time and have lost volatile components, particularly if the oil is very light.

Table 1-5 Bonn Agreement Oil Appearance Code

Code	Description-Appearance	Layer Thickness Interval (μm)	Liters per km^2
1	Sheen (silvery/grey)	0.04 to 0.30	40 to 300
2	Rainbow	0.03 to 5.0	300 to 5,000
3	Metallic	5.0 to 50	5,000 to 50,000
4	Discontinuous True Oil Color	50 to 200	50,000 to 200,000
5	Continuous True Oil Color	Greater than 200	Greater than 200,000

Observer experience will also have a marked effect on the accuracy of the estimate. The most accurate assessments of the quantity spilled can be made by accounting for losses from a vessel. If the type of oil is known as well as the time since spill, some computer programs can be very helpful in estimating the amount remaining. The volume of oil from an unlimited or unknown source may also be estimated from the areal extent and color of the slick.

- Slick thickness varies considerably, especially where it appears dark brown or black
- Most of the oil is located in areas where the slick appears brown or black
- Colored bands indicate an extremely thin slick of less than 1 micron or 0.001 mm

1.8 Oil Characteristics and Behavior

Table 1-6 summarizes the main physical/chemical properties, behavioral characteristics and adverse effects of various types of oil in seawater.

Table 1-6 Physical/Chemical Properties and Possible Adverse Effects of Common Oil Types During Spills

Oil Type	Physical/Chemical Properties	Adverse Effects on Environment
Light to volatile oils	<ul style="list-style-type: none"> • Spread rapidly • Tend to form unstable emulsions • High evaporation and solubility • May penetrate substrate • Removed from surfaces by agitation and low-pressure flushing 	<ul style="list-style-type: none"> • Toxicity is related to the type and concentration of aromatic fractions: 1) naphthalene, 2) benzene • Toxicity of aromatic fractions depends on their biological half-lives in different species • Toxic to biota when fresh • Mangroves and marsh plants may be chronically affected due to penetration and persistence of aromatic compounds in sediments
Moderate to heavy oils	<ul style="list-style-type: none"> • Moderate to high viscosity • Tend to form stable emulsions under high energy marine environments • Penetration depends on substrate particle size • Weathered residue may sink and be absorbed by sediment • Immiscibility assists in separation from water • Weather to tar balls 	<ul style="list-style-type: none"> • Adverse effects in marine organisms result from chemical toxicity and smothering • Toxicity depends on size of light fraction • Toxic effects reduced in tropical climates due to rapid evaporation and weathering • Low toxicity residue tends to smother plants or animals • Light fractions contaminate interstitial waters
Asphalt, #6 fuel-oil, Bunker C, waste oil	<ul style="list-style-type: none"> • Form tar balls at ambient temperatures • Resist spreading and may sink • May soften and flow when exposed to sunlight • Very difficult to recover from the water • Easy to remove manually from beach surface with conventional equipment 	<ul style="list-style-type: none"> • Immediate and delayed adverse effects due to small aromatic fractions and smothering • Most toxic effects due to incorporation in sediment • Absorption of radiated heat places thermal stress on the environment • Lower toxicity to marine plants than mobile animals

The chemical and physical properties of the spilled oil and ambient conditions will determine how the oil will behave. The basic processes and their time frames are shown in Figure 1-11.

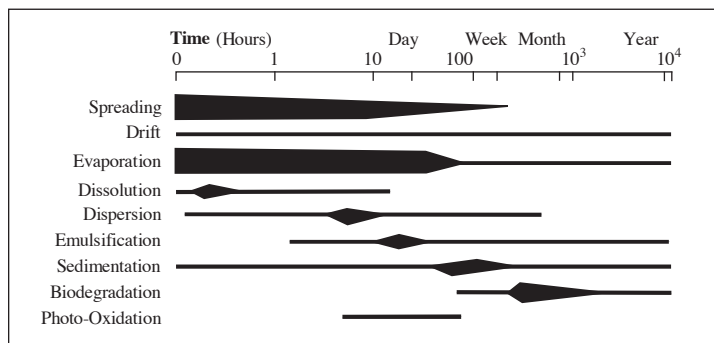

Figure 1-11 Processes Versus Time Elapsed Since the Spill

1.9 Limiting Access

A good contingency plan prepared for the area involved in a spill should identify the type of ecological or other constraints in the area addressed. Even if all of the types of constraints are identified, however, some of the actual restrictions may vary from year to year (e.g., nesting location of threatened species). Periods when transit through such areas or when cleanup can proceed will be apparent by noting other periods of high threat to resources. In defining constraints, data should be collected on:

- Resources affected
- The reason for restrictions on access (usage)
- The start and end dates for the restriction
- The activities that can continue during the restriction

Some restrictions may extend some distance away from the object or area to be protected. Maps may need to be prepared showing areas to be avoided while transporting survey teams or response workers to the spill site from remote bases.

1.10 Net Environmental Benefit Analysis

1

A process known as Net Environmental Benefit Analysis (NEBA) considers the advantages and disadvantages of oil spill response options in terms of their respective impacts on the environment. NEBA recognizes that cleanup responses have the potential to cause negative environmental impacts but may be justifiable because of overriding benefits and/or the avoidance of further impacts. An effective Net Environmental Benefit Analysis is a three-step process (Table 1-7).

Table 1-7 Net Environmental Benefit Analysis

Step	Activities
1	Identify and prioritize an area's ecological, socioeconomic, and cultural resources according to environmental sensitivity.
2	Evaluate feasible response options and compare them not only to each other but also to the option of natural recovery in order to define environmental benefits and drawbacks for all options.
3	Select the response option or combination of options that result in the greatest environmental benefit and/or least adverse effects on key resources.

The NEBA process can be applied to offshore, nearshore and inland spill response, and to shoreline cleanup. The following example considers offshore response:

- Step 1 After identifying the resources in all possible directions that oil might reach, it is determined that slicks could strand in a productive mangrove.
- Step 2 Options to prevent or reduce impacts to the mangrove include dispersants, mechanical cleanup and recovery, in-situ burning, and natural dispersion of the oil at sea.

Because the mangrove will be oiled with likely lethal effects if no action is taken, it is decided that natural dispersion/recovery is not an option.

Mechanical recovery, while it may be the least intrusive, is not efficient and likely to allow some oil to reach the mangroves. In-situ burning is also determined to be of limited efficiency. Dispersants, while they may have a short-duration negative effect on some marine organisms, are much more efficient at keeping oil from adhering to the mangroves, and will minimize the impacts to the mangroves, resulting in clear net environmental benefit.

Step 3 Dispersant application is selected as the preferred option.

Net environmental benefit should always be a key factor when making decisions on the optimum spill response options to implement.

2 Safety and Health

2

Protection of human safety and health is a fundamental objective of any ExxonMobil operation. Safe work practices help to minimize safety and health risks to responders and the surrounding community. Limiting access to affected areas is important to protect the public from exposure to spilled oil or interaction with response equipment. In addition to being familiar with the basic safety and health procedures outlined in this section, workers should refer to the site safety and health plan as well as company safety manuals and regional response plans for additional information.

2.1.1 Basic Safety Rules

Training is a key element in maintaining worker health and safety. In some countries training, such as HAZWOPER in the US, is mandatory. All response workers should have basic oil spill response safety training including, but not limited to:

- Site-specific safety and health rules
- Emergency procedures

The following basic safety and health rules should be followed by all spill response workers:

- Consider the potential safety and health hazards of each spill situation.
- Respond in teams, i.e., use the “buddy system”.
- Incorporate safety and health risk evaluations into all actions.
- Obtain health hazard data from the supporting industrial hygiene/safety/and/or medical personnel.
- Refrain from working in environments that exceed your training and/or capability.
- Always inform someone of your intended destination and the estimated time of your return.
- Refrain from entering or traveling in spill areas unnecessarily.
- Avoid skin contact with spilled material and use gloves and the protective clothing provided.
- Do not rely on your senses (e.g., smell) to determine hazardous conditions. Use detection devices.

2.1.2 The Buddy System

To provide a flexible and safe approach for response workers, a “buddy system” should be used during all response efforts. The minimum response team should include two people who perform the activity within direct line of sight of a third person who has communication or personnel resources to effect a “rescue”, if required.

The “buddy system” does not apply to equipment or process spills that can be controlled by one person using common equipment (e.g., valve leaks).

2.1.3 Hand or Whole Body Communication Signals

Verbal communication while wearing respirators is difficult because speech is muffled and distorted by the facemask. A set of hand or whole body communication signals known to all personnel is essential for working safely. Some of these emergency communication signals are listed in Table 2-1.

Table 2-1 Emergency Communication Signals

Signal	Meaning
Hand clutching throat	I am out of air!
Hands on top of head	I need assistance!
Thumbs up	Okay! I am all right. I understand.
Thumbs down	No! Negative!
Grip partner’s wrist or place both hands around partner’s waist.	Leave area immediately!

The potential safety and health risks associated with oil spill response efforts include:

- Fire and explosion
- Hazardous atmospheres/hazardous chemicals
- Slips, trips and falls
- Demanding physical activities under possibly adverse climatic and site conditions

2.2.1 Fire and Explosions

A major safety risk during crude oil or refined product spill response is from fire or explosions. This risk is site and substance specific and must be evaluated before response personnel enter a spill area or damaged vessel/equipment. Explosions present a physical risk from:

- Burns
- Flying debris
- Atmospheric over-pressure

Burning hydrocarbons result in a variety of combustion products. Therefore, only experienced personnel with proper safety, respiratory protection and hazard detection equipment should approach a burning vessel or spilled material. Remember:

- Always approach from the upwind, upstream, or uphill side, if possible.
- Retreat if heat intensity is severe or material is spreading.

When preparing to work in a potentially hazardous area, personnel should:

- Assess the need to enter the area.
- Determine the fire hazard potential of the material or mixture spilled.
- Be alert to possible oxygen deficiency.
- Obtain a combustible gas/oxygen meter that is calibrated and in good working order.
- Understand how the instrument will respond to the materials being measured.
- Test the atmosphere when approaching the spill (especially if in a vessel, tank manway, or low-lying area).
- Use equipment and tools that are intrinsically safe/explosion-proof.
- Observe confined space procedures if entering a confined space.

In potentially flammable atmospheres, restrict the use of instruments that are not intrinsically safe. These include:

- Open lights
- Flames
- Internal combustion engines
- Non-approved radio transmission devices
- Cellular phones

All hydrocarbons have a concentration range in which they are combustible. When either too little or too much hydrocarbon is present in air, the mixture will not burn. Also, in confined spaces, the oxygen level must be 10% or higher for combustion to occur. When evaluating the risk of fire or explosion, the key measurement is the lower explosive limit (LEL). The LEL is the lowest concentration of a vapor for a given material that will support combustion. Below this concentration, the mixture is too lean (dilute) and cannot support combustion. Detectors are used to determine whether or not a mixture is combustible. However, most combustible gas detectors (LEL meters) will not work properly in an area that has an oxygen concentration below 14–16%. Therefore, to test confined spaces or inerted containers for hydrocarbon level, the oxygen content must be measured first by properly protected personnel.

If LEL meter reading is:	Then:
0% (zero) to less than 10% of LEL	Hot work (i.e., with potential ignition sources) is allowed
Greater than 10% and less than 25% of LEL	Proceed with care, especially where there is poor air movement or circulation
Greater than 25% of LEL	Leave the area quickly and carefully

LEL meters do not detect toxic hazards. A reading of just one-tenth of a low LEL of 1.0% could still be toxic (1000 ppm of hydrocarbons can be dangerous to life and health)! Although flammability testing should be the first level of assessment, the decision to enter or work in an area should not be based solely on flammability.

2.2.2 Hazardous Atmospheres/Hazardous Chemicals

2

Crude oil contains substances that can cause acute as well as chronic health effects. Acute effects are more immediately evident and typically result from relatively short duration, high exposure conditions. Examples of acute effects include eye or skin irritation or even death under extreme exposure conditions. Most of the acutely toxic substances are highly volatile and are present in their highest concentrations soon after the spill. Chronic effects may develop some time after the initial exposure and are often associated with longer duration, lower concentration exposures. Chronic effects include certain diseases such as cancer.

Health advisors (e.g., Industrial Hygienists) are key in assessing whether or not an area is hazardous, especially early in a spill. Rely on them to determine proper protective measures for responders likely to be in the exposure zone. Such assessments should be based on the most likely level of exposure, taking into account the expected elevation of work activity, for example, boat deck level as opposed to water surface.

Health risk from inhalation of harmful vapors is lower for weathered crude than it is for fresh crude. In most cases, crude oil that has weathered for more than 6 hours is likely to have a much lower percentage of volatile compounds mainly due to evaporation. This could take longer in colder weather (see Section 15). Keep in mind that some tasks may agitate crude oil and increase the release of vapors.

The primary health risks associated with fresh crude are related to the inhalation of:

- Hydrogen sulfide (H_2S)
- Hydrocarbon vapors
- Benzene

Workers exposed to some of these substances through inhalation or skin contact may experience symptoms such as:

- Eye, nose, throat, or respiratory irritation
- Skin rashes or reddening
- Other adverse effects

Except for ingestion or aspiration of oil aerosols, the health concerns with weathered crude relate to skin exposure. Skin contact with hydrocarbons, as well as other potentially toxic substances, should be avoided through the use of proper protective equipment. Prolonged or repeated skin contact may result in dermatitis as well as increased body uptake of some crude oil components. Increased sensitivity to oils can also occur as a result of repeated exposures.

The nature of the hazards from refined products depends on their chemical composition. Typically, two categories of products are distinguished:

- Light-end refined products do not have significant H₂S concentrations, but contain a higher percentage of volatile aromatic (e.g., benzene) and oxygenated compounds.
- Heavy-end products and intermediates may contain H₂S, less volatile compounds, and a higher percentage of low-volatility polycyclic (or polynuclear) aromatic hydrocarbons (PAHs).

Health hazard assessment information should be obtained from the supporting industrial hygiene/safety and/or medical personnel. These individuals have been trained in the use of the specialized testing equipment necessary to conduct exposure assessments.

Typical health hazards for workers involved in crude oil or refined hydrocarbon spill response and First Responder Guidance are summarized in Tables 2-3 and 2-4. Selected items, including potential health issues seen after the initial response, are discussed in more detail following the tables (sections 2.2.2.1 through 2.2.2.8).

Exposure criteria are American Conference of Governmental Industrial Hygienists (ACGIH) Threshold Limit Values (TLVs). These limit values are current as of 2014. Where local laws or company limit values are more stringent, those limits should be observed. In addition, ExxonMobil has established its own Occupational Exposure Limits for benzene, hydrogen sulfide, and gasoline (Table 2-2).

Table 2-2 ExxonMobil's Occupational Exposure Limits for Benzene, Hydrogen Sulfide, and Gasoline

Substance of Concern	8-hr Exposure Criteria (ppm)	15-minute Exposure Criteria (ppm)
Benzene	0.5	1
Hydrogen Sulfide (H ₂ S)	5	10
Gasoline	100	200

Table 2-3 Health and Safety Information for Selected Substances⁽¹⁾

Substance of Concern	8-Hour Exposure Criteria	15-Minute Exposure Criteria	Odor Threshold	Air-Purifying 1/2 Facepiece Respirator Criteria	Cartridge or Filter Required	Air-Purifying Full Facepiece Respirator Criteria	Supplied-Air Respirator Criteria Positive Pressure Mode	Protective Clothing Selection	Flammability Range (% by volume)
Hydrogen sulfide	1 ppm	5 ppm	0.005 – 0.013 ppm (2)	Not suitable	N/A	Not suitable	≥5 ppm for more than 15 minutes	—	4.3 – 44.0
Hydrocarbon vapors (crude oil) (3)	100 ppm	200 ppm	0.11 ppm (4)	≥100 ppm <1,000 ppm	Organic vapor	≥1,000 ppm <5,000 ppm	≥5,000 ppm	Nitrile, Viton, Barricade™ Responder™ Eye goggles if irritation	Varies depending on oil
Gasoline	300 ppm	500 ppm	0.3 ppm	≥100 ppm <1,000 ppm	Organic vapor	≥1,000 ppm <5,000 ppm	≥5,000 ppm	Nitrile, Viton, Barricade™ Responder™ Eye goggles if irritation	1.3 – 7.1
Middle distillates	200 mg/m ³	<1,000 mg/m ³	N/A	200 – 2,000 mg/m ³	Organic vapor	≥2,000 mg/m ³ <10,000 mg/m ³	≥10,000 mg/m ³	Nitrile, Viton, Barricade™ Responder™ Eye goggles if irritation	0.6 – 6.5
Benzene	0.5 ppm	2.5 ppm	2.0–5.0 ppm (5)	≥0.5 ppm <5 ppm	Organic vapor	≥5 ppm <25 ppm	≥25 ppm	Viton CPF™, Responder™ Tychem 10,000™	1.3–7.9
Oxygen-deficient atmospheres (confined spaces)	Acceptable concentrations are from 19.5% to 23%		N/A	Not suitable below 19.5%	Not suitable below 19.5%	Not suitable below 19.5%	<19.5%	N/A	N/A

- (1) Some companies choose to adopt lower exposure levels consistent with their interpretation of the toxicological data. Always use what your company has adopted as an exposure limit unless local regulations are more stringent.
- (2) The “rotten egg” odor of H₂S should not be relied on to determine its presence or absence because elevated concentrations of H₂S can numb the olfactory nerves.
- (3) The vapors are hydrocarbons in the gasoline/naphtha range. The initial components that evaporate from crude oil are roughly equivalent to gasoline vapors. This number is based on the ExxonMobil Occupational Exposure Limit for gasoline, which is 100 ppm TWA and 200 ppm STEL. For spills of heavy hydrocarbons or middle distillate products, the guidance values are more severe (see sections 2.2.2.5 and 2.2.2.7 respectively)
- (4) May vary significantly between crude types and ambient conditions.
- (5) Reported threshold of sensory irritation to upper respiratory system.

Table 2-4 provides a step-by-step approach for establishing the overall safety of a work area.

Table 2-4 Health Monitoring Guidance for First Responders (Use with Table 2-3)

Step	Action
1. Establish LEL Level (a,b) <ul style="list-style-type: none"> • <10% LEL • 10–25% LEL • >25% LEL 	<ul style="list-style-type: none"> • Go to Step 2 • Go to Step 2 but carry out operations with care • Do not proceed to Step 2 until <25% LEL
2. Establish H₂S Level (c,d) <ul style="list-style-type: none"> • <1 ppm • >1 ppm 	<ul style="list-style-type: none"> • Go to Step 3 • See Table 2-3 for proper protection then proceed to Step 3
3. Establish Hydrocarbon Vapor Level (e,f) <ul style="list-style-type: none"> • <100 ppm (<27 ppm for jet fuel or kerosene and <11 ppm for diesel) • >100 ppm (>27 ppm for jet fuel or kerosene and >11 ppm for diesel) 	<ul style="list-style-type: none"> • Go to Step 4 • See Table 2-3 for proper respiratory and protective clothing protection and then proceed to Step 4
4. Establish Benzene Level (g,h) <ul style="list-style-type: none"> • <0.5 ppm • >0.5 ppm 	<ul style="list-style-type: none"> • Proceed with operations • See Table 2-3 for proper respiratory and protective clothing protection and then allow workers into the area

- a) Monitor in the worst-case spark zone (i.e., at the elevation with the highest potential exposure) with a calibrated instrument. Continue to monitor as conditions change, such as a drop in wind velocity.
Note: If monitoring in a confined space, monitor for oxygen first (see section 2.2.1)
- b) Numerous LEL monitoring devices are available and most refineries have them. Some of the devices also measure oxygen and hydrocarbon level. They all require calibration prior to use.
- c) Monitor in the worst-case breathing zone using a calibrated instrument. Continue to monitor as conditions or work tasks change. Contact the Industrial Hygiene rep to determine safe levels.
- d) A wide range of H₂S monitors are available. Colorimetric tubes also work.
- e) Exxon/Mobil OEL for gasoline is 100 ppm TWA, 200 ppm STEL. The TLV for gasoline is less stringent (300 ppm TWA, 500 ppm STEL.) Refer to Table 2-2.
- f) Photo-ionization detectors (PIDs) are commonly used to measure Total Hydrocarbons. Calibrate with 100 ppm isobutylene standard gas.
- g) Only a limited number of direct reading techniques can selectively measure <0.5 ppm of benzene in air. Two techniques that have been used are (1) compound specific PIDs (see above) and, (2) colorimetric samplers. Benzene PIDs with scrubber tube measure the current associated with ionization of benzene. Colorimetric samplers chemically react the benzene to form a color whose intensity can be correlated to concentration.
- h) Since benzene is a chronic hazard, the 8-hour criterion of 0.5 ppm can be met with limited exposure times at higher concentrations as long as the 15-minute criterion of 2.5 ppm is not exceeded.

2.2.2.1 Benzene

Benzene is a volatile component of crude oil that is a human carcinogen. Therefore, exposure to benzene should be kept within applicable exposure limits, as defined in Tables 2-2, 2-3, and 2-4.

2.2.2.2 2-Butoxyethanol

Some dispersants and remediation chemicals contain hydrocarbons such as 2-butoxyethanol (2BE) which can enter the body through the skin as well as through inhalation. This can result in temporary effects on internal organs, such as kidneys. Care should be exercised in handling these products.

Follow the handling guidelines provided on the MSDS, especially:

- Avoid skin contact when using products containing 2BE. If contact occurs, wash with water immediately.
- Avoid spraying these products in a manner that will produce large amounts of overspray or vapor exposure to workers.
- Wear proper protective equipment:
 - Respirators (Monitor using charcoal tubes or charcoal badges)
 - 20–200 ppm — Half facepiece respirator with organic vapor cartridges
 - 200–2000 ppm — Full facepiece respirator with organic vapor cartridges
 - >2000 ppm — SCBA: Self-Contained Breathing Apparatus
 - Gloves and Clothing
 - Butyl, Neoprene, nitrile, Viton[®], Saranex[™]

2.2.2.3 Carbon Monoxide

Burning crude oils or refined products produces carbon monoxide and other combustion products that must be assessed on a case-by-case basis. Do not place combustion equipment (generators, vehicles, direct-fire space heaters, etc.) that can generate carbon monoxide (CO) next to living areas and offices. Contact on-site industrial health and safety personnel for guidance.

The TLV for CO is 25 ppm as an 8-hour time weighted average. Since it has poor warning properties, SCBAs are required above this concentration.

Warning signs of carbon monoxide exposure are headache, dizziness and nausea. Higher levels of exposure cause reddening of the skin, weakness, mental confusion, and hallucinations.

2.2.2.4 Gasoline

Most of the vapors given off by gasoline are aliphatic and low molecular weight in nature. Volatilization is very rapid so dissipation will occur very quickly. Gasoline and other fuels with a low flash point present added safety concerns when spilled. Containment and skimming are **not recommended** due to potential fire or explosion hazard. Follow control recommendations listed in Tables 2-2, 2-3, and 2-4.

2.2.2.5 Heavy Hydrocarbon Products

Heavy hydrocarbon products are higher viscosity products such as heavy crude oils, bunker fuels, residual fuels, numbers 4–6 fuel oils, and gas oil. These materials can contain PAHs. PAHs are low volatility, high molecular weight hydrocarbons that with repeated contact can potentially cause skin and lung cancer. The TLV used by industry for these compounds is 0.2 mg/m^3 (as benzene soluble aerosol) and is listed under Coal Tar Pitch Volatiles. Primary protection against these materials is prevention of skin contact through the use of Personal Protective Equipment (PPE). Although risk from inhalation of volatiles is minimal (due to low vapor pressure), inhalation of aerosol mists (e.g., from steam or high pressure water clean-up techniques) should be avoided.

Primary protection against PAHs is the prevention of skin contact. Protective clothing should be worn to prevent any incidental skin contact. Materials that will adequately protect against PAHs include nitrile, Viton[®], Barricade[™], Teflon[™], 4H[™], CPF3[™], Responder[™], and Tychem 10,000[™]. If contact occurs, remove any contaminated clothing and wash thoroughly with soap and water.

The sensory threshold for these materials is about 1 mg/m^3 based on upper respiratory tract irritation. (The mg/m^3 designation is used here, not ppm, because PAHs are solid particulates, not volatile gases.) Half facepiece respirators with high efficiency filter and organic vapor cartridge should be worn in the $0.2\text{--}2.0 \text{ mg/m}^3$ concentration range. Full facepiece respirators with high efficiency filter and organic vapor cartridge should be worn in the $2.0\text{--}10.0 \text{ mg/m}^3$ concentration range, and SCBAs would be needed when there is greater than 10 mg/m^3 . Some companies believe that a more stringent value is necessary for proper protection (e.g., 0.1 mg/m^3). A 0.1 mg/m^3 guide would lower the above thresholds by a factor of 2.

2.2.2.6 Hydrogen Sulfide (H_2S)

Hydrogen sulfide, a byproduct of decomposing organic material, is a compound contained in some crude oils and refined intermediate products. Exposure to elevated concentrations of H_2S can be fatal. The primary exposure route is inhalation. Measurement of ambient H_2S concentrations should be performed when approaching a spill area. Remember these guidelines:

- H_2S is heavier than air and may accumulate in low storage areas, pump rooms, or confined spaces.
- H_2S has the distinct odor of rotten eggs that can be detected at concentrations as low as 0.006 ppm; however, the sense of smell should not be used in place of a detection device because H_2S can deaden the sense of smell at high concentrations.
- At low concentrations (1 ppm to 150 ppm), H_2S is irritating to the eyes, nose and respiratory system.
- At elevated concentrations (above 500 ppm), rapid paralysis of the respiratory system can occur.

Follow control recommendations in Tables 2-2, 2-3, and 2-4.

If H_2S is detected above 1 ppm, evacuate the area immediately until expert help and specialized equipment are available.

2.2.2.7 Middle Distillate Products

Petroleum materials boiling between 145 and 450 degrees C are called middle distillates. They include kerosenes, diesel fuels, jet fuels, and heating oil. These products are of greater concern in the aerosol form than in the vapor state so the TLV levels are considerably lower than for crude and gasoline. Repeated or intermittent dermal exposure to these materials can lead to dermal irritation and may be associated with an increased risk of skin cancer.

Primary protection against these materials is through the proper use of PPE. Protective clothing selection would be similar to that recommended in Table 2-3. If contact occurs, remove any contaminated clothing and wash thoroughly with soap and water.

The current TLV for kerosene is 200 mg/m³ (about 27 ppm) and for diesel is 100 mg/m³ (about 11 ppm). For kerosene, half facepiece respirators with organic vapor cartridges should be worn in the 27–270 ppm concentration range. Full facepiece respirators with organic vapor cartridges should be worn in the 270–1350 ppm concentration range, and SCBAs would be needed when there is more than 1350 ppm.

For diesel, half facepiece respirators with organic vapor cartridges should be worn in the 11–110 ppm concentration range. Full facepiece respirators with organic vapor cartridges should be worn in the 110–550 ppm concentration range, and SCBAs would be needed at over 550 ppm.

2.2.2.8 Oxygen

Oxygen concentrations below 19.5% (at sea level) are viewed as **Immediately Dangerous to Life and Health (IDLH)** environments. Low oxygen atmospheres are possible in enclosed spaces. Therefore, strict entry controls and permits as well as proper air supply respiratory protection are required. SCBAs are required in oxygen atmospheres less than 19.5%.

Effects of oxygen abnormalities are listed below:

Oxygen Levels	Effects
Approximately 6%	Difficult breathing with death in minutes
Approximately 17%	Impaired judgment and headaches
Greater than 23%	Raises the danger of combustibility

A health professional should be consulted for work performed at higher elevations to assess any potential health effects due to the reduced concentration of oxygen.

2.2.2.9 Overall Guidance

It is essential that responders understand the potential atmospheric hazards existing in the environment that they are expected to work in. Generally, health and safety experts will be onsite to characterize the quality of the ambient air prior to allowing response workers into a suspect area. However, in the event that testing is delayed, the following general guidelines may be useful:

- Responders at a spill where oil is still fresh should wait for testing before proceeding or wear respiratory protection.
- Responders arriving 6 hours or more after a spill in open water with good air circulation (which is usually the case) can probably proceed without concern for the issues discussed above unless the spill is quite large (over 10,000 bbls). For contained spills or spills on land, the issues are more relevant.
- Always avoid prolonged skin contact with hydrocarbons.
- Always approach the spill from the upwind direction.

2.2.3 Heat and Cold

Climatic conditions pose additional risks to cleanup workers. One of the primary responsibilities of each person is to monitor his/her “buddy” for symptoms of heat or cold stress. All workers should be trained to recognize and guard against the symptoms and provide the appropriate first aid. Both conditions are described on the following pages.

2.2.3.1 Heat Stress (Hyperthermia)

Heat stress is caused by the inability of the body to dissipate excess heat generated from physical exertion, temperature and humidity, or the wearing of protective clothing and equipment. Responding to spill emergencies increases the risk for heat stress. The use of protective equipment (especially in tropical areas) compounds the problem by increasing the heat load, preventing adequate heat dissipation and decreasing evaporative cooling. It is important to prevent heat-induced illnesses and injuries and recognize early symptoms of heat stress.

More serious heat-induced illnesses or injuries are often caused by ignoring early symptoms.

The four “stages” of heat stress and their relevant first aid recommendations are presented in Table 2-5.

2.2.3.2 Cold Stress (Hypothermia)

Cold stress is caused by a rapid loss of heat from the body that can cause localized minor to severe injuries, as well as system dysfunction. The most prevalent cold stress injuries involve the extremities: typically the hands, ears, nose and/or feet.

All workers in cold climates must be trained to recognize and guard against the symptoms of cold stress and provide proper first aid. The stages of cold stress and their relevant first aid recommendations are outlined in Table 2-6.

Some form of immersion protection must be worn by personnel at risk of falling in water at temperatures below 68°F (20°C). Speed is essential when rescuing a person who has fallen overboard.

Table 2-5 Heat Stress Stages and Appropriate First Aid

Heat Stress Stage	Symptoms	Typical Causes	First Aid Recommendation
Heat Rash (prickly heat)	<ul style="list-style-type: none"> Rash on the skin. 	<ul style="list-style-type: none"> Humid environment or wearing protective equipment that holds moisture next to the skin. 	<ul style="list-style-type: none"> Provide place for worker to thoroughly wash skin. Offer rest periods in cool location. Apply medicated powder.
Heat Cramps	<ul style="list-style-type: none"> Muscle spasms in hands, feet, abdomen. May also be accompanied by nausea/vomiting. Person becomes quiet/stops work. 	<ul style="list-style-type: none"> Large electrolyte loss due to sweating which disrupts the electrolyte balance in the body. 	<ul style="list-style-type: none"> Offer fluids with proper balance of electrolytes, such as commercially available sports drinks. Offer rest periods for routine fluid intake.
Heat Exhaustion	<ul style="list-style-type: none"> Pale, clammy, moist skin. Nausea/headache, dullness of response/work pace. Person may become quiet, sit down, or faint. 	<ul style="list-style-type: none"> Excessive water loss, inadequate replacement. Worker may not be acclimatized to work, equipment and/or climate. 	<ul style="list-style-type: none"> Relocate worker to cool place (shade). Remove protective equipment (if appropriate). Offer plenty of liquids with electrolytes. Seek medical care/advise.
Heat Stroke	<ul style="list-style-type: none"> Skin may be dry, reddish, and hot. Person may faint or become disoriented. Convulsions may occur with vomiting and rapid pulse rates. 	<ul style="list-style-type: none"> Temperature regulatory control has failed. Body can no longer rid itself of excess heat. 	<ul style="list-style-type: none"> Seek medical care immediately! Remove protective clothing. Wet with cool water, cold beverage bottles. If person is conscious, provide small but continuous amount of cool water/electrolytes. Do not leave person unattended.

Table 2-6 Cold Stress Stages and Appropriate First Aid

2

Cold Stress Stage	Symptoms	First Aid Recommendation
Frost Nip	<ul style="list-style-type: none"> • Sudden whitening of the skin. • Skin is still flexible but firmer than normal. • Pain is typically experienced. 	<ul style="list-style-type: none"> • Warm worker's affected body part slowly. • Keep worker warm until color and sensation of touch return to normal.
Superficial Frostbite	<ul style="list-style-type: none"> • Skin has "waxy" or white appearance. • Skin is not flexible on the surface. • Beneath the surface, tissue is still flexible. • Painful. 	<ul style="list-style-type: none"> • Warm worker's affected body part slowly. • Provide warm shelter and offer warm fluids. • Seek medical follow-up.
Deep Frostbite	<ul style="list-style-type: none"> • Bodily tissue is cold, pale and solid. 	<ul style="list-style-type: none"> • Seek immediate medical care. • Cover worker but do not try to bend or flex body part prior to medical care.
Hypothermia in Air (gradual loss of core temperature)	<ul style="list-style-type: none"> • Shivering. • Personality change. • Slow movement. • Person may become gradually quiet over several minutes. • Shivering may stop and person may be conscious but not coherent. 	<ul style="list-style-type: none"> • Seek immediate medical care. • Perform CPR if necessary. • Gently remove wet clothing, cover with dry blankets or a sleeping bag (get in with victim to provide extra warmth). • If conscious, give "sips" of warm water or milk. • Do not give alcohol. • Never leave the victim alone.
Hypothermia Due to Immersion (rapid loss of core temperature)	<ul style="list-style-type: none"> • Even a short immersion unprotected in cold water can cause rapid hypothermia. • Death could occur in less than 30 minutes. • Above symptoms occur rapidly. 	

2.2.4 Site Conditions

Historically, most injuries during a spill response have been from slips, trips, and falls. These can be minimized through the concept of **Present Moment Thinking**:

- Be aware at all times.
- Think of what you are doing, not what you are going to do next.
- Guard against daydreaming.

2.2.5 Miscellaneous Hazards

2.2.5.1 Noise

If you need to shout to communicate within 2–3 feet (0.6–1 meters) of each other, sound pressure levels (noise) are assumed to be above the threshold for wearing hearing protection (85 decibels). Wear hearing protection when continuously exposed to noise levels above 85 decibels.

2.2.5.2 Other Hazards

Also be aware of hazards from:

- Solar radiation
- Large mammals (e.g., bears)
- Venomous snakes
- Other domestic or wild animals
- Poisonous plants (e.g., poison ivy)
- Insect bites and stings
- Off-road vehicle accidents (e.g., roll-over)
- Uneven terrain
- Dangerous weather (lightning, hail, strong winds)
- Blood or other body fluids (use a mask or barrier device for CPR)

2.3 Protective Equipment

2

Protective equipment suitable for the exposures and risks should be used by all spill response personnel. Protective equipment will typically consist of:

- Hard hats
- Gloves
- Coveralls
- Boots
- Safety glasses
- Eye goggles
- Respirators
- Hearing protection
- Insect repellants and mosquito netting in tropical areas

The type of protective equipment selected is determined by the material that has been spilled, the tasks to be performed, and environmental factors.

It is important to have established policies on the protective equipment to be used and to ensure that these policies are followed, especially in a large operation.

2.3.1 Protective Clothing

The materials for protective clothing should be selected for oil and refined product spills based on the following factors:

2.3.1.1 Splash Potential Only

Workers exposed only to occasional splash, vapor or mist

Rain suits along with industrial rubber boots typically give adequate body protection against splashes. Gloves selected for a specific hazardous material may also be required depending on the work being performed.

2.3.1.2 Hydrocarbon Immersion Potential

Worker has potential for repeated immersion of hands, feet, or body parts

Workers who will have body parts potentially exposed to hydrocarbon contamination should use permeation-resistant protective equipment that affords the best level of protection for the specific hazardous material and/or mixture.

All materials are eventually permeable to a contaminant. Therefore, always limit direct contaminant contact. Workers must be trained to properly don, seal, and remove equipment, and to guard against heat or cold stress while working in this equipment.

Hard hats and safety shoes should be used for all field work. Non-slip soles should be provided for marine and wet work areas.

2.3.2 Respiratory Protection

The risk of inhaling oil vapors or other hazardous compounds is typically highest immediately after the spill but can continue throughout the cleanup. Additional inhalation exposures could occur during in-situ burning and during the use of chemical countermeasures used to combat the spill such as dispersants, beach cleaners, or chemicals used to promote microbial degradation of oil. Respiratory protection can be provided by an air-purifying respirator or a self-contained breathing apparatus (SCBA)/air-line system. Responders carrying out typical daily tasks would not normally be expected to wear SCBA gear. The following points should be considered when selecting air-purifying respirators:

- Consult the responsible safety or industrial hygiene personnel before issuing or using respirators.
- Employees with facial hair will not be assigned work requiring respiratory protection. **Respirator users must be clean-shaven.**
- All workers must have training and fit testing before using respirators.
- Only certified respirators will be used.
- Air-purifying respirators do not protect against H₂S, carbon monoxide, or any other material for which they are not designed.
- Filters or cartridges remove contaminants from the air and must be properly selected for the anticipated hazard. They will not protect in oxygen-deficient environments.
- Cartridges (organic vapor/acid) have a limited service life. When odor is detected, replace the cartridge.
- Cartridges and filters can be combined to afford protection against a variety of vapors, particulates, and gases.
- Cartridges from one brand cannot be safely used with another brand of respirator.
- Depending on the concentration and potential for irritation, either half face piece or full facepiece respirators can be worn (see Table 2-3).

- Workers wearing glasses should use a spectacle kit for full-face piece respirators. Lenses can be ground locally to fit in a frame provided by the respirator manufacturer. Regular eyeglasses cannot be worn in respirators. Contact lenses should never be worn in areas where irritating vapors could be present.

Supplied-air respirators are used when air-purifying devices do not provide enough protection. They are required for confined space entry (see below), environments that are **Immediately Dangerous to Life and Health (IDLH)** and other high exposure risk areas. Environments that are greater than 3000 ppm TPH or less than 19.5 % oxygen (at sea level) are IDLH.

Workers must have hands-on training before using supplied-air respirators in the field. There are two types of supplied-air respirators:

- **Self-contained:** Good for short period (1-hour duration or less) emergency/rescue only. These should have a full facepiece and a pressure demand regulator.
- **Air-line:** Good for long-duration work. Should have emergency bottles to allow enough time for safe exit if air supply is lost. (NOTE: 300 feet or 100 meters of air line is the maximum allowable length from the air source.)

All respirators must be cleaned, decontaminated, disinfected, and air-dried after use. They should be inspected and repaired before they are put back into service. Qualified personnel must perform servicing.

2.3.3 Confined Space Entry

Spill response efforts sometimes require workers to enter confined spaces such as tanks and cargo holds that have limited access and poor ventilation. On-site industrial hygiene and safety professionals should establish the exact confined space entry procedures and the required protective equipment. Conditions within these confined spaces can change quickly. Therefore, the atmosphere must be tested ($O_2 \rightarrow$ LEL \rightarrow $H_2S \rightarrow$ TPH \rightarrow Benzene) before entry and tested continuously throughout the work. Portable equipment with preset audible and visual alarms should be used.

2.4 Personal Health

Workers have the responsibility to maintain their personal health

- Complete periodic medical evaluation.
- Keep an ample supply of personal medications and be sure to pack them.

- Carry a spare set of corrective lenses.
- Keep immunizations up-to-date.
- Keep anti-malaria medication on hand (as applicable) for up to ten days of protection.
- Notify your management if there is any change in health status that would preclude working in areas with substandard medical care.

2.5 Transportation Safety

2.5.1 Small Boat Safety Rules

Small boats are used extensively during crude oil or refined product spills on large bodies of open water. Some basic safety rules are as follows:

- Select boats that are appropriate for the conditions at hand, i.e., do not use calm water, shallow draft boats offshore.
- There should be sufficient personal flotation devices for all persons aboard and these must be properly worn at all times when persons engage in the following activities:
 - Working near the deck edge.
 - Boarding and disembarking.

Personal flotation devices are only effective when they are secured.

- Decks are slippery: **Be careful!**
- Do not overload the vessel.
- When traveling in a boat:
 - Obey speed limits at all times especially in and out of inlets and ports.
 - Yield right of way as required by navigation rules.
 - Have a proper first aid kit, emergency signal kit, and communications equipment, navigation equipment, running lights, and warning horns on board.
 - Avoid setting out in bad weather or rough seas unless absolutely necessary and deemed safe to do so.
 - Always inform someone of your trip destination, course, radio frequency, planned activities, and estimated time of arrival/return.
 - No smoking or alcohol use.
- Dress warmly; in winter, temperatures away from the coastline usually decrease and the wind chill can be significant.

2.5.2 Aircraft Safety Rules

Prior to flying, the pilot will give passengers a pre-flight safety briefing (see Chapter 16 for more details). However, some basic safety rules are as follows:

- Stay out of the water unless absolutely necessary; remember, hypothermia can occur in minutes.
- The pilot is in charge of the aircraft and passengers during all phases of flight and in emergency situations.
- When approaching or leaving the aircraft:
 - Approach after the pilot has signaled.
 - Always approach or leave at a 90° angle to the aircraft nose and in view of the pilot.
 - Never walk near or under the tail rotor of a helicopter or near the propeller of an airplane.
 - Always approach or leave a helicopter in a crouched position unless it fully stopped.
 - Do not disembark any aircraft until instructed by the pilot.
- Passengers and pilots must wear:
 - Seat belts at all times — from takeoff until after the aircraft has landed.
 - Hearing protection on all helicopter flights.
 - Inflatable life jackets during over-water helicopter flights.
- Smoking by passengers and pilot is prohibited on or near the aircraft.
- Persons under the influence of drugs or alcohol must not be allowed to board.
- Learn the location of and know how to operate emergency exits and emergency equipment such as life rafts, emergency equipment kits, and fire extinguishers.
- Do not inflate the life jacket or the life raft inside any aircraft.

2.6 Decontamination

Personnel involved in any oil spill cleanup operation can get very dirty. It is important to keep oily gear and dirty personnel out of living quarters in order to maintain satisfactory conditions. One way to do this is to set up personnel decontamination facilities for workers coming off the job. This includes facilities for cleaning and storing soiled personal protective equipment followed by washing, showers, and lockers, as appropriate. A typical design of a decontamination facility can be set up as follows in a serial arrangement:

entrance → dirty side → showers → clean side → exit

3 Logistics and Communications

3

3.1 Introduction

This section discusses the logistics required to support workers who participate in response operations. It also includes some of the communications needs to effectively manage a response as the conditions of an oil spill change. The mobilization of personnel, supplies, and cleanup equipment into the spill area is not discussed.

3

3.2 Logistics

A rapid response is essential for effective spill cleanup. Effective logistics ensure the expedient and efficient mobilization of resources and sustained resource availability throughout the response effort. Some key logistics elements are described below:

Logistics planning usually includes the following key points:

Table 3-1 Key Logistics Elements

Resources	Support	Services
<ul style="list-style-type: none">• Contracts for goods and services• Procurement• Shipping/receiving• Warehouse/staging• Inventory management• Equipment tracking	<ul style="list-style-type: none">• Transportation• Provisioning• Permits• Waste management• Assembly, fabrication and maintenance• Demobilization	<ul style="list-style-type: none">• Decontamination• Security• Facilities• Administrative services

- Prioritize objectives and allocate resources accordingly.
- Allocate equipment appropriate to the job:
 - Use fixed-wing aircraft for heavy loads and extended flights.
 - Use locally available aircraft when possible.
 - Locate fuel depots near work areas.
- Acquire marine charts, tide tables, maps, weather forecasts, aviation charts (especially near controlled airspace).
- Obtain procurement documents: purchase orders, contracts, and rental agreements.
- Acquire necessary permits if required:
 - Hazardous goods transport
 - Industrial waste disposal
 - In-situ burning

- Chemical applications (e.g., dispersants, shoreline cleaners, etc.)
- Vessel docking
- Aircraft
- Land or property access
- Approvals for various activities (e.g., washing booms in place)
- Implement financial controls:
 - Do not make long-term agreements.
 - Document all transactions and agreements.
 - Appoint expenditure officers; limit signing authority.
 - Control inventory of equipment and supplies.
 - Track purchase orders, invoices, contracts, and labor charges.

3.2.1 Resources

Various response team sections should work together to identify the resources, support and services required for a response operation. A detailed Material Take Off (MTO) list can then be compiled to summarize the findings. Sample MTO lists specific to each area of spill response are provided in:

- Section 4 (Tracking and Surveillance)
- Section 5 (Boom)
- Section 6 (Shoreline Protection)
- Section 7 (Dispersants)
- Section 8 (In-Situ Burning)
- Section 9 (Skimmers)
- Section 11 (Transfer Systems)
- Section 12 (Shoreline Treatment)
- Section 13 (Oiled Wildlife Response)
- Section 14 (Waste Management)

These MTO lists are not intended to be all-inclusive but instead provide an idea of the scope and equipment typically required for each type of spill response operation.

Planning all spill cleanup phases from start to finish not only saves time and effort but also can allow operations to continue without major interruptions.

3.2.1.1 Contracts

Contractual arrangements should be made as soon as possible for outside goods and services identified on the MTO.

3.2.1.2 Procurement

Procuring goods and services identified on the MTO should begin as soon as possible. All goods and services ordered should have an end-use designation based on field requirements. This will minimize over- or under-ordering.

3

3.2.1.3 Shipping/Receiving

In the early stages of a response, a functional system for the receipt of equipment and supplies is essential. Incoming freight must be efficiently managed to ensure timely delivery to the appropriate field destination. The receiving area should be the point at which inventory control and material accounting are initiated. Shipping procedures also need to be established. Examples of items that may be shipped from a spill location include samples collected for laboratory analysis, equipment needing repair, and materials that need to be returned.

Customs clearance procedures specific to the country should be established prior to receiving equipment and supplies or shipping materials out of the region. **Customs clearance can be a potential issue if not addressed early in the response.**

3.2.1.4 Warehouse/Staging

Staging areas should be identified as early as possible in the response so that when equipment is received, it can be sent to the appropriate location. Staging areas are temporary. They are located for the convenience of the response and moved or decommissioned as appropriate. Warehouses may also need to be established to securely store reserve supplies, spare parts, and equipment, plus function as a shipping and receiving facility.

3.2.1.5 Inventory Management

An inventory management system needs to be established as soon as possible. The system should include all aspects of inventory control such as procurement, receipt, issue, use, and final disposition.

3.2.1.6 Equipment Tracking

The status of all resources assigned to response should be tracked and reported daily to the Operations Manager or his/her designee. The status should include in-transit, standby, and activated or deployed resources from every source, including those from emergency response organizations and agencies.

3.2.2 Support

3.2.2.1 Transportation

Transportation involves the movement of personnel and material to and throughout the field. It includes marine, land, and air operations. Providing adequate transportation is a priority, especially during the early stages of response.

- *Marine Transportation*
 - Vessels of opportunity (e.g., tugs, barges, workboats, fishing boats) for boom tending, shuttle service, security, supplies delivery, storage, and waste/debris collection
 - Landing craft and skiffs for shoreline treatment and cleanup
 - Barges and ships for worker accommodations/berthing
 - Dedicated spill response vessels and barges

In U.S. waters, waivers may be available from the U.S. Coast Guard for the short-term emergency use of vessels that do not have a Certificate of Inspection.

Check local regulations and certification requirements when operating outside U.S. waters.

- *Land Transportation*
 - Buses, cars, light trucks, and all-terrain vehicles
 - Heavy-haul vehicles (e.g., dump trucks, flatbeds, and tractor trailers)
- *Air Transportation*
 - Fixed-wing aircraft, including float planes, for heavy cargo and extended flights; also for surveillance and passenger transport
 - Helicopters, both single and double rotor

3.2.2.2 Provisioning

Provisioning can be divided into two categories: Field (offshore) Provisioning and Onshore Provisioning.

- *Field (Offshore) Provisioning*
 - Personnel assigned to the field will require various levels of provisioning, including fuel, food, housing, water, supplies, and sanitation facilities.
- *Onshore Provisioning*
 - Response personnel stationed onshore will require food, shelter, supplies, and sanitation facilities. Local commercial establishments

may be available for some workers, but depending on the size of the response effort, temporary housing and canteen facilities may need to be brought into the area.

- To facilitate planning, provisioning requirements should be determined from Operations Section (Figure 1-1) before personnel are dispatched to field locations.

3.2.2.3 *Permits*

Various permits may be required, including for the following activities:

- Hazardous goods transport
- Industrial waste disposal
- In-situ burning
- Chemical applications (e.g., dispersants, shoreline cleaners, etc.)
- Decanting of separated water
- Vessel docking
- Aircraft landing
- Land or property access
- Activities involving oiled equipment or oily waste management (e.g., washing booms in place, oily waste decanting)

3.2.2.4 *Waste Management*

Both short- and long-term waste management plans should be developed during the early stages of a spill response operation. The plans should consider mechanisms for waste collection, containerization, storage, transportation, disposal, and tracking.

3.2.2.5 *Assembly, Fabrication, and Maintenance*

Most equipment will require some level of assembly and testing to ensure its readiness for the field. These activities may include attaching hoses and fittings, installing batteries, or matching power supplies/packs to equipment (e.g., skimmers). Other equipment and/or facilities may need to be fabricated on site. This may require the expertise of mechanics, technicians, and various craftsmen. Systems should be in place for both preventative and remedial maintenance of response equipment. Maintenance activities may be carried out at the work location or at a pre-established central maintenance area. Fuel, lubricating oil, hydraulic oil, and other fluids will be required to keep vessels, aircraft, and vehicles operational.

3.2.2.6 *Demobilization*

Demobilization can occur very early in the response, and continue throughout as operational requirements change. Demobilization plans should be prepared for vessels, equipment, personnel, contractors, and facilities.

3.2.2.7 Decontamination

Decontamination capability must be provided in all responses. Plans should be prepared early in the response to address personnel, vessels, and equipment. Only approved cleaning chemicals should be used.

- *Personnel Decontamination*
 - Personnel decontamination will be required throughout the response effort. Personnel decontamination units can be fabricated on site or commercial modular units may be leased or purchased.
- *Vessel Decontamination*
 - Boats will accumulate oil on their hulls at and near the waterline. Soiled boats should not be brought into uncontaminated harbors without first being cleaned.
 - Boat hulls may be manually washed from a low-freeboard pontoon float in a temporary slip constructed inside a protected, boomed-off area.
 - Small skimmers may be pressure-washed while being suspended over a wash pit.

If the location of the cleaning station does not have direct access to shore facilities, a barge may be needed to provide supplies, communications, shelter, and sanitary facilities.

- *Equipment Decontamination*
 - Equipment decontamination will be necessary before equipment is moved through or to uncontaminated areas. This is especially evident as contaminated boom is moved from containment to protection or storage, or when cleanup equipment is moved from one area to another. See Section 5.12 of this manual for more details on boom washing.

3.2.3 Services

3.2.3.1 Security

Security should be established early in the response to control access to restricted areas such as the Command Center, docks, offices, warehouses, and lay down yards. The security function should also control access to the spill site. It may be necessary to interface with local agencies and police departments to assist with access control and/or to coordinate on possible terrorist activity. The security function can also provide surveillance for wild animals and assist with accounting for personnel en route to and from the spill site.

3.2.3.2 Facilities

Facilities must be located and established to accommodate various needs for the spill response. Facilities include the Command Center, briefing rooms, lay down yards, storage facilities, housing, and offices. Facility maintenance such as trash collection, sanitation, parking, shuttle service, and catering must be considered.

3

3.2.3.3 Administration

Administrative services support the response by ensuring the availability and reliability of administrative equipment and services. Examples include office machines, computers, fax machines, copy machines, forms, mail, courier service, clerical support, record keeping, local transportation, parking, and media equipment.

A sign-in and sign-out procedure will help ensure that the whereabouts of all participants who are actively involved at a spill cleanup site are known. Similarly, spill response equipment and materials used for cleanup duty from warehouses, trailers, and other facilities also should be tracked.

3.3 Communications

Effective communication is critical to command and control. One of the first priorities of the Emergency Response Manager is to establish a communications network that will cover the geographical area and provide for communications among all parties involved in the response. The Communications Unit in the Logistics Section of an ICS structure is responsible for providing these services.

There is a need for voice, text, data network, and field radio communication capabilities during an incident. It may be necessary to acquire dedicated telephone lines and internet services, plus equipment from a local phone company or internet service provider to provide communications and connectivity for response teams. For spill response crews or vessel or aircraft crews, radio communications must also be established to coordinate operations.

Key considerations for establishing telephone and computer network access include:

- There can be a lead time before obtaining services for a field command center from telephone and network providers (e.g., DSL service).
- Mobile WiFi hotspots are effective devices for interim communications via laptop computers using remote VPN access.
- Hotels or similar facilities may have internet and telephone services and could serve as field command centers.
- Local service providers and radio shops can be sources of rental communications equipment.

Communications systems and their applications are summarized in Table 3-2. Ranges of UHF and VHF radio transmissions are summarized in Table 3-3.

Table 3-2 Telephone, Radio, Satellite, and Internet Communications Applications

Type	Use			Range
	Description	Voice	Data	
Cellular telephones	Mobile communications (Use where network is available. Some cell phones are capable of push-to-talk, Walkie-Talkie functionality. Texting may succeed when regular calling does not.)	✓	✓ (if network is suitable)	Within area served/many worldwide
VHF-FM marine (156-158 MHz)	Inter-vessel communications (Use marine channels 9, 10 and 16 in US waters; channels may vary elsewhere)	✓		Line of sight
VHF-AM aircraft (118-136 MHz)	Ground-to-air communications (Use 123.050 or 122.850.)	✓		Line of sight
UHF oil spill (454/459.000 MHz) (US only)	Company frequencies for field coordination (Use intrinsically safe radio in hazardous locations.)	✓		Line of sight
High frequency (HF) radio (2-20 MHz)	Single sideband (SSB) (Use offshore.)	✓		30+ miles (48+ km)
General Mobile Radio Services (GMRS) (462 and 467 MHz range)	Ground- to -ground communications using small hand-held walkie-talkies. (Requires an FCC license in the US)	✓		2-3 miles
Inmarsat Satellite	Voice and facsimile (Use offshore or in remote locations where approved.)	✓	✓	Worldwide
Low Earth Orbit (LEO)	Good for communication in remote areas (e.g., Iridium, Globalstar)	✓	✓	Worldwide

Table 3-2 Telephone, Radio, Satellite, and Internet Communications Applications
(continued)

Type	Use			Range
	Description	Voice	Data	
Geostationary satellite	Good for communication in remote areas (e.g., Inmarsat)	✓	✓	Worldwide; yet not guaranteed at high latitudes (e.g., >80°N)
Push-to-Talk	Cellular-based offering, which allows Walkie-Talkie type functionality on some cell phones	✓		Vendor-specific offerings limits availability
Voice Over Internet Protocol (VoIP)	Can make and receive calls using telephone numbers via a broadband internet connection	✓		Worldwide
Telephone, facsimile, and modem	Voice, computerized data, and facsimile (Transmission systems require time to implement.)	✓	✓	Not mobile

Key considerations in implementing a communications network include:

- Obtain appropriate government communications licenses.
- Ensure that communications specialists are accessible.
- Ensure that marine weather forecasts are accessible.
- Ensure that individuals and groups have access to frequencies of common interest and follow a frequency allocation plan established by the Communications Section (Figure 1-1).
- Use intrinsically-safe/explosion-proof radios in hazardous environments.
- Allocate a dedicated safety / calling channel
- Individual work crews should use separate frequencies if available.
- Place UHF repeater stations as high as possible.
- Repeaters should be visible from all points in the coverage area:
 - Maximum range using repeater stations is about 60 miles (100 km).
 - Higher frequency signals (UHF) are more attenuated by vegetation than are VHF signals; use VHF in wooded areas.

- The number of radio channels will increase over time during a major spill.
 - Consider communication security needs: VHF and UHF are open channels
 - Consider integrating an incident communications network with any Common Operating Picture which may contain pre-populated, in-field infrastructure information

*Table 3-3 Range of UHF and VHF Radio Transmission
Versus Antenna Altitude*

Altitude		Range	
Feet	Meters	Miles	Kilometers
0	0	Up to 5	Up to 8
60	20	Up to 20	Up to 30

3.3.1 Common Operating Picture (COP)

More widespread use of Geographic Information Systems (GIS) and electronics by responders to share information has led to the development of a computer-based tool, a Common Operating Picture (COP). COPs use GIS architecture to store and display a variety of geospatial data that can include hundreds of data layers from different data sources (e.g., Responsible Party, agencies, states, institutes). A COP is typically operated from within an incident command post and provides access to real time information on response operational status. Core data themes include weather, infrastructure (e.g., hospitals), personnel tracking, assets (e.g., boom location), trajectories, imagery (e.g., overflight), and facility information. Data management, information acquisition, and vetting duties must be addressed to maintain and operate a COP.

There is a strong and growing interest in the development of COPs because they provide (1) near real time situational awareness, (2) access to the same information by various groups in a response, (3) aid for decision making, and (4) a communications tool for internal and external use. The benefits of COPs are most obvious for complex incidents and will require greater personnel support.

4 Surveillance and Tracking

4

4.1 Introduction

Surveillance and tracking operations are critical in planning spill countermeasure options. Surveillance and tracking approaches consider observed slick size, location, and predictions of slick behavior, which are based on understanding of the processes that control oil movement and removal from the water surface.

Oil spilled into the aquatic environment is subject to various physical and chemical processes that cause the oil to change (weather) and migrate. Some processes cause oil to be removed from the water surface, while others change its form on the surface. Important factors that influence the behavior and fate of spilled oil include:

- Physical and chemical characteristics, such as viscosity, specific gravity, volatility, and maximum water content
- The quantity of oil spilled
- The prevailing weather and sea state conditions

Figure 4-1 depicts these processes, which are further described in Table 4-1.

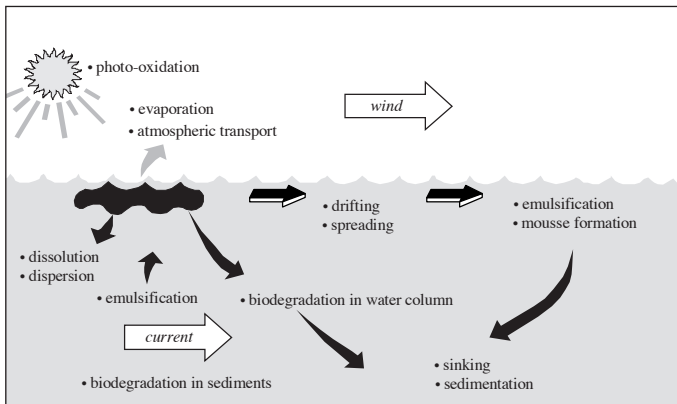

Figure 4-1 Processes Acting on Spilled Oil

Table 4-1 Processes Acting on Spilled Oil on Water

Process	Definition	Effects on Oil Spill Response
Drifting	Physical movement of surface oil from one location to another due to the combined effects of winds, and tides	Moves the location of oil slicks, which may affect response strategies
Spreading	Expansion of oil on the water surface due to gravity and advective spreading	Expands the areal extent of oil slicks as thickness diminishes
Evaporation	Physical-chemical process resulting in transfer of hydrocarbons from the water surface to the atmosphere	May result in the loss of 1/4 to 2/3 of the oil mass within a few hours or days and generally increases the viscosity of remaining spilled oil. Viscosity changes affect the selection of response options.
Emulsification and Mousse Formation	Formation of water in oil emulsions; can contain as much as 75–80% water	Increases density, viscosity, volume, and flash point of spilled oil; may affect selection of cleanup options
Dispersion	Transport of oil from the water surface into the water column due to wave action	Decreases volume of surface oil
Dissolution	Physical-chemical process resulting in dissolution of hydrocarbons in the water column	Small percentage of total amount; important because of potential toxicity
Sinking/ Sedimentation	Increase in density of oil due to weathering and interaction with suspended sediments or material of biological origin; deposition of material to the bed of the water body	Tracking and recovery of oil can be difficult and laborious, if not impossible; exposes organisms in water and possibly bed of the water body to oil
Atmospheric Transport	Transport of evaporated hydrocarbons in the atmosphere	May affect response decisions due to the concentration of hydrocarbons in the atmosphere; safety of personnel is the key issue
Biodegradation	Biological process altering or transforming petroleum hydrocarbons through microbial action	Slow process relative to other weathering mechanisms. Has limited effect on near-term oil fate or spill response
Photo-oxidation	Transformation of petroleum hydrocarbons through interaction with sunlight	Effects are negligible relative to other weathering mechanisms

4.2 Oil Properties and Fate

Regardless of their physical and chemical properties, all oils will weather once spilled. The rate of weathering depends on the conditions at the time of the spill and the nature of the spilled oil.

The following parameters are used to characterize oil properties:

4.2.1 API Gravity

4

A lower API Gravity indicates a higher specific gravity, and generally a higher viscosity. Physical removal methods are commonly used to recover very low API Gravity oils. High API Gravity usually implies low viscosity and a higher percentage of light ends. Oils with very high API Gravity are usually non-persistent and are more likely to evaporate or to be dispersed either naturally or using dispersants. High API Gravity oils may also be more readily burned, if circumstances allow. API Gravity can be calculated as follows:

$$\text{API Gravity} = (141.5/\text{Specific Gravity}) - 131.5$$

4.2.2 Flash Point

The flash point is the lowest temperature at which vapors above a volatile combustible substance ignite in air when exposed to a flame or spark. Fuels with a low flash point, such as gasoline, present additional safety concerns when spilled. Containment and skimming of low flash point oils are **not usually recommended** due to the fire or explosion hazard. Most response options can be considered for removing petroleum products with higher flash points, such as diesel, from the water surface. However, light oils, such as aviation gasoline, condensates, or Jet B, will naturally disperse and evaporate, quickly eliminating the need for response in non-sensitive areas.

4.2.3 Lower Explosion Limit

The lower explosion limit or LEL is the lowest concentration of a material's vapor in air that will support combustion. For a spill of a petroleum product with a low flash point, flammability (explosion) limits must be measured at the accident site to determine if there is a fire or explosion hazard. Many gas monitors also measure oxygen levels. Response operations can only proceed once safe working conditions are assured.

4.2.4 Viscosity

High viscosity (e.g., weathered, low API Gravity crude oil) limits response options. While mechanical recovery may be possible, dispersion and in-situ burning are usually less effective. If dispersant application is to be attempted on viscous oils, trials should be carried out prior to full application and only dispersants formulated for use on heavier oils should be considered.

4.2.5 Wax Content

High wax content in crude oils can limit the selection of appropriate countermeasure equipment as waxes will tend to crystallize at low temperature, increasing viscosity (see Pour Point).

4.2.6 Pour Point

The viscosity of some high wax/asphaltene content oils and many weathered crude oils can reach such high levels that they no longer flow at ambient temperatures. The temperature at which this begins to occur is called the pour point. Solidification of the spilled oil rules out most response options except for solids-handling equipment and certain special pumps.

4.2.7 Solubility

Most petroleum hydrocarbons have low water solubility. Other products, such as ethanol, are soluble as well as volatile and flammable and often cannot be recovered once spilled on water.

4.2.8 Specific Gravity (Liquid)

Petroleum hydrocarbons generally have a specific gravity less than that of water and will therefore float. However, some hydrocarbons, such as bitumen and asphalt, are normally heavier than water. Weathered Bunker C, some crude oils, and other heavy fuel oils can also sink over time after being spilled rendering conventional response options inapplicable.

4.2.9 Specific Gravity (Vapor)

The vapors of most hydrocarbon fuels are heavier than air. This affects response activities when vapors accumulate as the result of booming operations, confined spaces, or other vapor-concentrating factors. The health and safety of response personnel must then be considered in flammable or low-oxygen atmospheres.

4.3 Forecasting Slick Drift

Oil slicks drift under the effect of wind and surface currents. The combined effects of currents and approximately 3–5% of the wind velocity are vectorially additive (Figure 4-2). Oil spill trajectory models can be useful in forecasting slick movement. Generally, the wind component plays a greater role in oil coming ashore than the current. A key source of information during spill response is local knowledge. Mariners, fishermen and nearby residents can be asked to assist in determining the expected direction of movement of slicks.

4

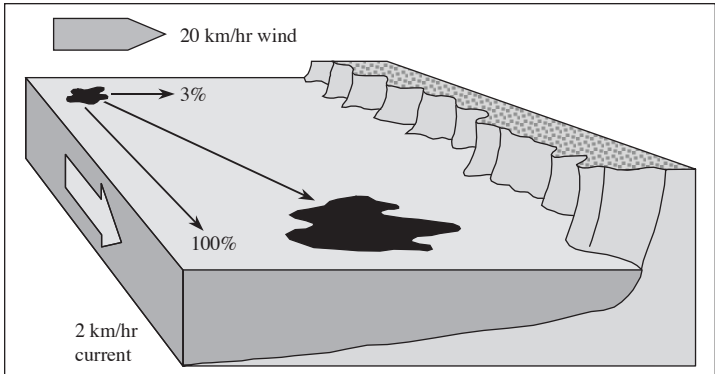

Figure 4-2 Movement of Oil on Water

In the above example, the tidal and wind-driven current vectors must be added to estimate when a slick might reach a shoreline. The direction “to” for current and “from” for wind should be noted (e.g., current *to* the east and wind *from* the north).

Oil spill models have been applied to predict or forecast the movement of surface slicks and identify areas, amenities, and biological resources that have a higher probability of spill impacts. The priority areas that might be affected by spilled oil will require the application of various countermeasure options for protection. Because oil spill trajectory models are complex and selection of appropriate input data (e.g., oil property and environmental information) is important, modeling slick trajectory and behavior should be conducted by experts. The participation of persons with local knowledge is critical in this process if accurate depictions are to be made of tidal fluctuations and patterns, shore types, and resources at risk (including seasonal aspects).

4.4 Estimating Slick Volumes

The volume of oil spilled should be estimated using as many methods as possible. Methods for estimating spilled volume include:

- The rate of flow through a pipeline and the duration of spill before shutoff
- The size and number of cargo tanks breached on a grounded vessel
- The color and size of slick areas

Estimating oil volume based on the color and size of slicks is complicated due to the complexity of slicks, their geometry and other factors. Observer experience will have a marked effect on the accuracy of estimates. The following rules should be considered when estimating slick volumes:

- Slick thickness can vary considerably even in a single slick. If there are dark brown or black patches, most of the oil is located in these darker areas.
- Colored or silvery bands indicate extremely thin slicks; these colors can often be seen at the borders or outer areas of thicker slicks.

Table 1-4 can be used to estimate slick volumes based on their estimated area and appearance. As discussed in Section 1.7, there is high variability in these reported thicknesses and they should only be used for estimating order of magnitude amounts of oil. Using them to estimate amount of oil spilled can be very inaccurate.

4.5 Visual Observation and Photography

Visual observation and aerial photography have been used effectively in open water for identifying and tracking oil spills. The volume and properties of spilled oil can be estimated using color and area measurements from an aerial photograph. Aircraft used for aerial observation must allow good all-around vision and carry suitable navigational aids. Fixed wing aircraft should be used for long range observation. Helicopters are best for near-shore waters and coastlines. For best coordination, observers should sit on the same side of the aircraft as the pilot. The direction of the sun may dictate the best direction to fly a search pattern. The search altitude is generally determined by the visibility. In clear weather, 500 meters (1640 feet) is optimal for maximizing the scanning area without losing detail. Visual observations and the use of conventional cameras can be hindered by lack of visibility due to weather conditions, including rain, fog, and darkness. Oil can be difficult to visually detect in water with algal blooms or high levels of sediment as well as over kelp and seagrass beds. Additional information on aerial observation can be found in Chapter 16.

Ground-truthing (i.e., verifying data at the water surface) is usually used to confirm visual sightings of slicks. In general, silvery and rainbow-colored sheens are not amenable to removal by skimmers, chemical dispersion, or in-situ burning, because of their thinness. Response options should be focused on slicks that are brown to black in color.

There is a wide range of cameras available that are mainly used for mapping purposes but that also can be applied to oil spills. To give contrast to visible imagery so that the darker-color thick slicks can be distinguished from iridescent sheens, cameras can be equipped with a horizontally-aligned polarizing filter and set at 53° from the vertical (the “Brewster angle”). In this way, light reflected from surface oil is photographed. Television cameras can be similarly used for spill work. Scanners in the visible spectrum are also used as oil sensors. In the past, the advantage of such scanners was their ability to produce digitized signals. However, digital cameras and recorders are now readily available that offer similar capabilities.

4.6 Tracking Buoys

Tracking buoys can be used to study current patterns. This information can be useful in predicting the trajectory of an oil spill. Several tracking buoy designs have been developed including radio- and satellite-tracked units.

4.7 Remote Sensing

There are a number of airborne sensors available to assist in the detection and mapping of spills. Operation of airborne sensors and interpretation of results requires highly trained personnel. The most commonly employed and most practical sensors are infra-red (IR), ultra-violet (UV), and side-looking airborne radar (SLAR). A combination may be used to overcome the limitations of individual sensor types.

4.7.1 Infrared Sensors

Oil absorbs solar radiation and re-emits infrared (IR) radiation at a wavelength different than that of the surrounding water; therefore, oil spills in open water can be detected using infrared cameras. Such cameras are commercially available and comparatively easy to use. New systems are sold that can allow data logging, position determination and data transmission. Infrared video, in addition to true color video and photography, has been found to be a useful tool for determining and documenting the location of oil spills.

The application of IR sensors is limited by low cloud cover (or “ceiling”). However, they can be used at night in clear skies. Also, many other sources of sea surface temperature variation (e.g., tidal currents, river outflows, industrial cooling water effluent, sewage outfalls, etc.) interfere with this remote-sensing technique. Still, the merits can often outweigh the disadvantages, and IR can be useful in tracking large, coastal oil spills.

4.7.2 Ultraviolet Sensors

Oil slicks reflect ultraviolet (UV) radiation, even in thin layers, making it possible to map oil slicks using ultraviolet sensors. Due to light interference from sun reflection, waves and biological material, ultraviolet images are best used in combination with infrared images to provide a more positive indication of the presence of oil. UV techniques are applicable only to daytime operations.

4.7.3 Laser Fluorosensors

Laser fluorosensors work on the principle that many compounds, such as oil, absorb ultraviolet light and re-emit some of this energy in a distinctive visible wavelength. Airborne systems are capable of classifying oil and other marine pollutants in day- light as well as at night on water, in broken ice conditions or on solid ice. More recent developments in this technology allow the production of detailed map-based oil contamination information by overlaying color-coded markers of oil contamination on video images. A dedicated aircraft is often needed for fluorosensor instrumentation.

4.7.4 Radar

Radar can be used to detect oil slicks due to reflective differences in the radio signal sent to and received by an oil-free water surface and a surface that is wave-dampened by oil. Interferences, however, include certain current patterns, ice, slicks associated with freshwater or biological activity, wind-calmed or wavy water, vegetation, and various effluents

Side-looking airborne radar (SLAR) and synthetic aperture radar (SAR) are two types of systems that have application to oil spills. Both can be used for quick coverage of large areas and may be useful in detecting oil slicks in open water. They work in darkness, and through fog and clouds. SAR is capable of much greater range and resolution than older SLAR technology.

4.7.5 Satellite Remote Sensing

Satellite sensors have application to oil spills and have been applied to many situations. Systems such as LANDSAT and SPOT have been tried. Two factors, however, combine to lower the probability of detecting a spill by satellite. These are the frequency with which the satellite passes over the spill site and the reliance on clear skies to “see” the spill.

4

Satellites with SAR (e.g., RADARSAT) provide an indication of possible pollution and its location and dimensions. SAR is not limited by the presence of clouds. It requires considerable time to collect and transmit satellite data, which may affect its usefulness in response operations. Additionally, it takes time to interpret the results to ensure that slicks are identified as being distinct from other elements of the imagery.

4.7.6 Surveillance and Tracking of Subsea Oil

Oil spills may require surveillance and tracking of oil that does not reach the water surface, but instead may be entrained at depth. There are two mechanisms that would cause this to happen:

- the oil that is released has a greater API gravity than the water and/or
- oil droplets are small enough ($<70 \mu\text{m}$) to prevent any appreciable rise through the water in the event of subsea dispersant use.

Heavier oils are more likely to sink and be found at the bottom than lighter oil. Oils at the bottom may become covered by sediment. If this occurs, surveillance methods could include sampling by ponar sediment grabs, sediment cores, and scuba diver ‘spot’ checks. For plumes in the water column, surveillance methods depend on the expected size and concentration of the plume. Methods can include side scan or multibeam sonar or a laser light scattering (e.g., LISST). The use of ROV, AUV and glider platforms is becoming increasingly frequent for oceanographic surveys in the water column. These platforms can be fitted with a variety of sensors and cameras.

4.7.7 Surveillance and Tracking of Oil under Ice and Snow

The current practice is to drill numerous boreholes into ice over water and then conduct extensive sampling to map the oil’s location. Oil may rise up boreholes for visual detection. Slick mapping can be aided by using information gathered as to quantity of oil observed in boreholes plus the number of boreholes where oil is observed.

There are two remote sensing techniques that hold promise in the near future: high-frequency ground penetrating radar (GPR) and nuclear magnetic resonance (NMR). Both may allow a faster rate of sampling, and subsequently greater spatial coverage.

In either manual or remote sensing, the use of markers to track the location of the spill as ice moves is recommended. Markers also can be used to delineate the perimeter of oil spilled to land under snow and ice conditions.

Tracking oil beneath floating ice may become a priority when active response measures are not possible. Place radio and/or satellite position buoys strategically in the oil deposition zone to monitor ice movements. Place pylons with light strobes on ice floes in the oil slick to assist aerial tracking. Conduct aerial reconnaissance using visual observations and remote sensing devices (e.g., airborne FLIR: forward-looking infrared).

4.8 Material Take Off (MTO) List

Table 4-3 Material Take Off (MTO) List for Tracking and Surveillance

Equipment	Use
Still image and true color video cameras	Photographing spill
Tracking buoys	Tracking slick
Remote sensing equipment	Detecting slick on water surface, in the water column, and beneath snow and ice
Trajectory and fate oil spill models	Predicting slick movement and weathering
Computers	Running oil spill models, collecting photographic images, performing calculations, and communications
Aircraft	Slick spotting
Radios	Communication among vessels/aircraft
GPS	Identifying slick position

5 Boom

5

5.1 Introduction

A boom is a floating physical barrier used to control the movement of oil. Boom is typically the first mechanical response equipment taken to a spill site. It is used to 1) contain slicks for removal by skimmers or burning, 2) deflect or divert slicks towards a collection area or away from sensitive resources, 3) exclude slicks from selected areas and protect sensitive shorelines and amenities, and 4) ensnare oil by the addition of sorbent material. Boom is manufactured in a wide variety of designs, sizes, and materials for different applications. Personnel responsible for selection and use of boom should:

- Understand the function of basic components and ancillary fittings common to most boom.
- Identify the boom in terms of its expected location of use, water conditions, and spill response operation.
- Consider the listed design factors that affect a boom's performance including its durability, storage, deployment, and oil containment potential. Manpower requirements also need to be evaluated.
- Select an appropriate size of boom according to environmental conditions and expected performance.
- Consider which boom types can be most effectively used on a spill. Refer to data for each boom type, which includes a description, recommended uses, and operational considerations.
- Consult the manufacturer-supplied data to obtain technical specifications for specific boom models.
- Consult ASTM Standards for information on boom connectors and other standardized information.

5.2 Boom Components and Fittings

Boom has four basic components (Figure 5-1): flotation, skirt, tension member(s), and ballast. Freeboard and draft are the portions of a boom's flotation and skirt above and below the waterline, respectively.

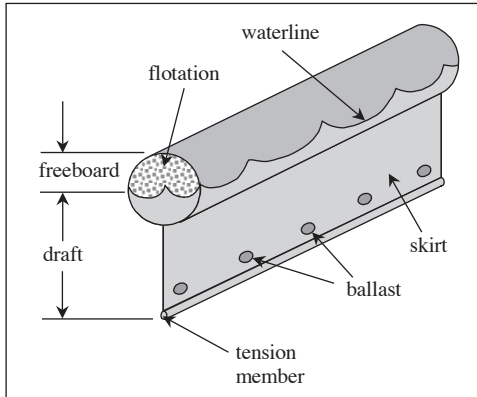

Figure 5-1 Boom Design

Flotation

- Flotation positions the boom at the water surface.
- Buoyancy chambers usually contain foam or air.
- Heavier boom used in rough, offshore conditions requires more flotation than lighter boom used in calm, nearshore or inland waters.

Skirt

- The skirt is intended to prevent oil from escaping below the boom.
- Forces from currents acting on a boom increase with skirt depth and can cause skirt failure (i.e., entrainment), allowing oil to escape.

Tension Member

- Tension members bear the load imposed by towing, winds, waves, and currents.
- Chains, cables, or webbing that run the length of a skirt or flotation are used.

Ballast

- Ballast (weighting material) helps keep a skirt vertical in water.
- Ballast often consists of a chain, wire cable, or weights located along a skirt bottom. The chain or cable could also serve as a tension member.

Freeboard

- Boom freeboard prevents splashover of oil.
- Wind forces on a boom increase with freeboard surface area. If freeboard exceeds 4–8 in (10–20 cm), boom performance can be adversely affected by high winds (typically 20 knots (kts) or 37 km/hr).

5

Draft

- Boom draft prevents oil from escaping under a boom in low current conditions.
- Shallow draft skirts reduce tension on a boom.

An understanding of the function of not only basic components of a boom, but also its auxiliary fittings or features, is required so that specific operational needs can be met:

Anchor Points Eye bolts on end connectors along a lower tension member used to secure anchor or mooring lines.

End Connectors Connectors join sections of boom to one another, to accessory devices, or to skimmers. ASTM F962 standard connectors are recommended to insure uniform inter-connection with other booms.

Lifting Points Attachments to an upper tension member of a boom are used to lift it by helicopter, crane, or davit.

Stiffeners Vertical members in flexible gaps between flotation elements add stability to some boom, particularly flat, internal flotation boom.

Handholds Handholds facilitate manual deployment, retrieval, and storage.

Towing Devices Wire towing bridles and paravanes (floating tow connectors) prevent a boom from being twisted and damaged when it is towed.

5.3 Operational Factors

Various other performance and design factors should be evaluated to determine which boom types work best for a particular application.

5.3.1 Roll Stiffness

Roll stiffness is the resistance of a boom to turnover in high currents and winds. Roll stiffness can be increased by adding ballast to the bottom of a boom skirt or by providing a flotation member above the vertical center of gravity of a boom. Pressure-inflatable boom exhibits high roll stiffness.

5.3.2 Heave Response

Heave response (boom conformance) is the ability of a boom to conform to waves and minimize oil losses due to splashover and underflow (bridging of waves). Self-inflating and pressure-inflatable boom have good heave response as does internal foam flotation boom with relatively short flotation members. Boom with rigid flotation or rigid skirts generally do not exhibit good heave response.

5.3.3 Freeboard and Skirt

Freeboard height and skirt depth should be optimized when selecting boom. Increased freeboard will generally decrease the probability of boom failure due to splashover; however, it will tend to lower the roll stiffness of a boom in high winds. Similarly, an increased skirt depth will decrease the probability of oil escaping under a boom in slow currents while oil will tend to break away and escape under a boom in fast currents due to entrainment, regardless of skirt depth. Increased skirt depth will increase the loading on a boom and will result in decreased heave response.

If deployment in unprotected water is anticipated, a boom that has high reserve buoyancy (weight of water displaced by a boom minus boom weight) should be used. Reserve buoyancy is also commonly expressed as buoyancy:weight ratio (boom buoyancy divided by boom weight).

5.3.4 Tensile Strength and Puncture Resistance

Tensile strength and puncture resistance are important factors to consider when open water deployment is anticipated, or when extended lengths of boom will be towed over long distances. Deployment in areas with debris requires high tensile strength and good puncture resistance of the boom fabric. Fence boom with conveyor belt skirts and durable floats perform well in these conditions. Generally, the fabric and the boom tension members combine to bear the forces acting on the boom.

5.3.5 Ease of Storage and Deployment

Ease of storage, deployment, and retrieval must be considered when choosing boom. Flat and inflatable boom can be stored compactly on a reel, on the deck of a vessel, or in a container; however, an air blower must be used to deploy most pressure-inflatable models. The deployment and retrieval of any boom require examining the potential location of its use and corresponding needs for personnel, vessels, and ancillary equipment.

5.3.6 Other Features

5

Important aspects that relate to operational considerations when selecting boom include the following:

- The volume occupied per unit length of a boom so that storage requirements can be planned for a designated space or reel.
- The number, type and quality of auxiliary components such as connectors, anchor points, and lifting points.
- High visibility boom material (e.g., yellow and international orange) as well as use of reflective tape and warning lights, particularly if a boom is to remain deployed at night.
- Smooth surfaces to prevent oil losses through vortices and to facilitate cleaning.
- Design of flotation, seams, bridles, stiffeners, and tension members for ease of use and cleaning, and to deflect debris.
- The durability of boom material (including the use of UV protection and marine growth inhibitors).

5.4 Boom Failure

There are five basic types of operational boom failure:

- Entrainment
- Drainage
- Splashover
- Submergence
- Planing

Each type of failure is discussed below.

5.4.1 Entrainment Failure

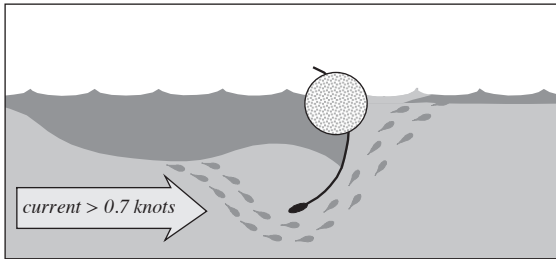

Figure 5-2 Entrainment Failure

Entrainment failure generally occurs at current velocities between 0.7 and 1.0 kts (0.4–0.5 m/s). A headwave forms upstream of a boom and turbulence occurs on the downstream side of a headwave. This turbulence causes oil droplets to escape under a boom. The amount of oil lost during entrainment failure depends on the thickness of oil in a headwave. The velocity at which a headwave becomes unstable and oil droplets flow under a boom is called the critical velocity. Critical velocity is a function of current velocity and waves and is the component of water speed perpendicular to the boom. Entrainment failure may be prevented by deploying boom at an angle less than 90° to the direction of flow or by using multiple porous boom designed to operate in fast currents.

Boom deployment angle as a function of current velocity is approximately:

1 knot: 45-90° 2 knots: 20-30° 3 knots: 15-20° 4 knots: 10-15°

5.4.2 Drainage Failure

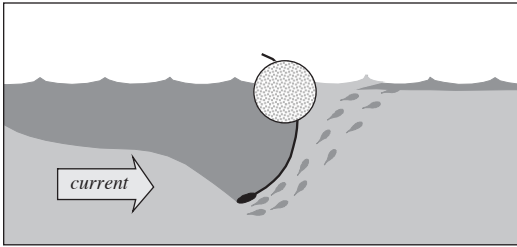

Figure 5-3 Drainage Failure

Drainage failure rarely occurs. It can happen when a skirt boom is used to hold so much oil that oil flows down the face of the boom skirt, escaping to the other side. Increasing skirt depth is not usually a solution since it increases the potential for planing failure (Section 5.4.5).

5.4.3 Splashover Failure

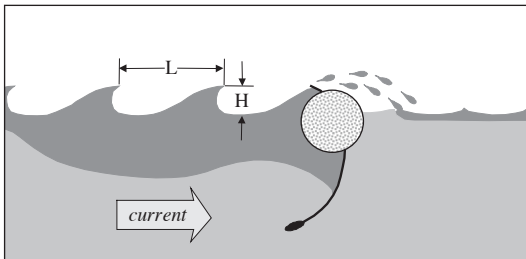

Figure 5-4 Splashover Failure

Splashover failure may occur in choppy water when wave height (H) is greater than boom freeboard and the wave length:height (L/H) ratio is less than 10:1. Most booms, however, perform well in gentle, rolling swells, even when the wave height is much larger than the freeboard.

5.4.4 Submergence Failure

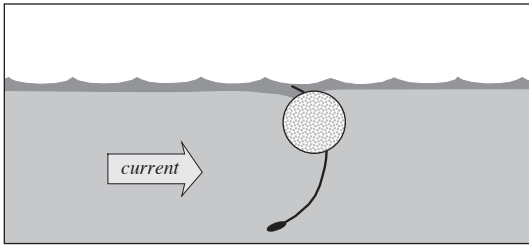

Figure 5-5 Submergence Failure

Submergence failure may occur when a boom is deployed or anchored in a fast current or is being towed too fast. The tendency for boom to submerge at a given speed is determined by the boom's reserve buoyancy (the buoyancy in excess of that required to keep a boom afloat in still water). Higher reserve buoyancy reduces the tendency to submerge. Submergence failure is not common because entrainment failure usually occurs at a much lower speed.

5.4.5 Planing Failure

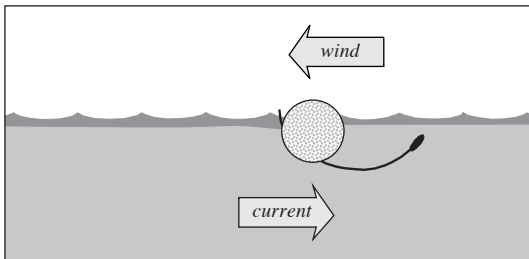



Figure 5-6 Planing Failure

A strong wind and strong current moving in opposite directions may cause a boom to heel flat on the water surface. The resulting loss of oil is called planing failure. This failure is most likely to occur when a boom has inadequate ballast or when an internal tension member is near or above the waterline.

5.5 Boom Application

Boom that incorporates the previously described features is sold in a wide variety of models for use in harbors, coastal waters, offshore areas, lakes, and rivers. Their performance ranges from excellent in calm, low current waters to poor in high wave, wind, and current conditions (see Table 5-1).

Table 5-1 Boom Performance Versus Conditions

Wind	Waves	Current	Boom Performance
0–10 kts (0–20 km/hr)	Calm, swells	0–0.5 kts (0.25 m/s)	
> 20 kts (>40 km/hr)	< 3–4 ft (<1 m)	> 1 kt (>0.5 m/s)	

Boom is available for deployment from shorelines, docks, vessels, reels, containers and platforms. Boom selection involves anticipating the following application factors:

- Mode of deployment and time likely required for launching
- Probable location(s) of application
- Deployment vessels to be used
- Possible sea and debris conditions
- Approximate duration of the operation

Boom can be classified for use in three different sea states: **calm**, **protected** and **open water**. The sea condition most directly determines the appropriate size of boom to be used. Table 5-2 shows the ranges of freeboard and draft corresponding to maximum wave heights that a boom can adequately withstand.

Table 5-2 Boom Size Versus Sea State

Sea State	Wave Height		Boom Size			
			Freeboard		Draft	
	ft	m	in	cm	in	cm
Calm	<1	<0.3	4–10	10–25	6–12	15–30
Protected	1–3	0.3–1	10–18	25–45	12–25	30–60
Open water	>3	>1	>18	>45	>25	>60

Booms are used for three primary applications:

- Containment** Boom is used in little or no current to isolate a spill, to control spreading, to concentrate the oil, and to facilitate its recovery by skimmers.
- Deflection** Boom is deployed at an angle to a drifting slick to divert oil away from sensitive areas or to a collection point. One or more booms can be used to direct a slick to an advancing skimmer for recovery.
- Protection** Booming is used to exclude slicks from sensitive shorelines and/or amenities. With the addition of sorbent material, booms can also be used to collect oil.

The selection of boom depends on how quickly it is needed, how easily it can be deployed and how rugged or durable it is. The speed and ease of deployment usually depend on the equipment and number of people required. For example, self-inflating boom can be deployed very rapidly either from reels or bundles; however, if extended deployment is required, a more rugged boom that is slower to deploy (e.g., pressure-inflatable) will perform better. Generally, ease and speed of deployment are tradeoffs with ruggedness and durability.

5.6 Boom Selection

Most commercially available boom can be categorized into one of four basic design types:

- Internal foam flotation
- Self-inflating
- Pressure-inflatable
- Fence

Specialty boom is available including those manufactured with sorbent and fire-resistant materials (Section 8.3), shore-sealing barriers (Sections 5.10.1 and 6.5.4), and netting to trap high viscosity or solidified oil (Section 5.10.2).

Table 5-3 rates the four generic boom types according to environmental conditions in which they will be deployed, performance characteristics, and convenience.

Table 5-3 Boom Selection Matrix

		Type of Boom			
		Internal Foam Flotation	Self Inflating	Pressure-Inflatable	Fence
Environmental Conditions	Open Water	◐	◐	○	●
	Protected Water	○	○	○	◐
	Calm Water	○	○	○	○
	High Current (>1 kt)	◐	●	◐	●
	Shallow Water (<1 ft)	○	◐	◐	●
Performance Characteristics	Operation in Debris	○	●	◐	◐
	Excess Buoyancy	◐	○	○	●
	Wave Response	◐	◐	○	●
	Strength	◐	●	○	○
Convenience Features	Ease of Handling	◐	○	◐	◐
	Ease of Cleaning	○	○	○	○
	Compactibility	●	○	○	●
<p>Legend ○ Good ◐ Fair ● Poor</p> <p>Open Water Wave height >3 ft Current velocity <1 kt Protected Water Wave height 1–3 ft Current velocity <1 kt Calm Water Wave height <1 ft Current velocity <0.5 kt</p> <p>Not all boom of a particular type have the rating shown.</p>					
<p>1 foot = 0.3048 m 1 kt = 0.5144 m/s</p>					

To derive the most benefit from the boom selection matrix (Table 5-3), follow these steps:

- Identify the most likely environmental conditions in which boom will be used. Note the boom types that have an acceptable rating (good or fair).
- Identify the performance characteristics most needed for the intended application. From the boom type chosen above, select those with an acceptable rating (good or fair) for the most important performance characteristics.
- Identify the most desirable convenience features. For the boom type chosen from steps 1 and 2 above, select the boom with the best rating in the convenience features of interest (good or fair).

When selecting a specific boom type there may be a choice of fabrics (e.g., polyester, nylon, or aramid). Several protective coatings may be available. Table 5-4 outlines the advantages and disadvantages of four common coating materials.

Table 5-4 Boom Coating Materials

Coating	Advantages	Disadvantages
PVC	<ul style="list-style-type: none"> • Excellent flexibility 	<ul style="list-style-type: none"> • Limited long-term resistance to sunlight, heat, hydrocarbons, and organics
Inhibited PVC	<ul style="list-style-type: none"> • Resistant to sunlight, heat, hydrocarbons and organics 	<ul style="list-style-type: none"> • Not as resistant to organics as urethanes
Polyether urethane	<ul style="list-style-type: none"> • Best weather and water resistance 	<ul style="list-style-type: none"> • Not as resistant to organics as polyester urethane
Polyester urethane	<ul style="list-style-type: none"> • Best resistance to organics 	<ul style="list-style-type: none"> • Not as weather-resistant as polyether urethane

Once installed, boom requires continuous tending, particularly in locations of reversing tidal currents. Operational planning should factor in time for boom tending activities.

5.7 Types of Boom

Sections 5.7.1 through 5.7.4 compare variations of the 4 major types of boom. Wave following, ease of deployment, and oil retention are three characteristics used in the comparison. Advantages and disadvantages as well as recommended uses and operational considerations are also discussed. For overall performance of each of the 4 types of boom, refer to Table 5-3.

5.7.1 Internal Foam Flotation Boom

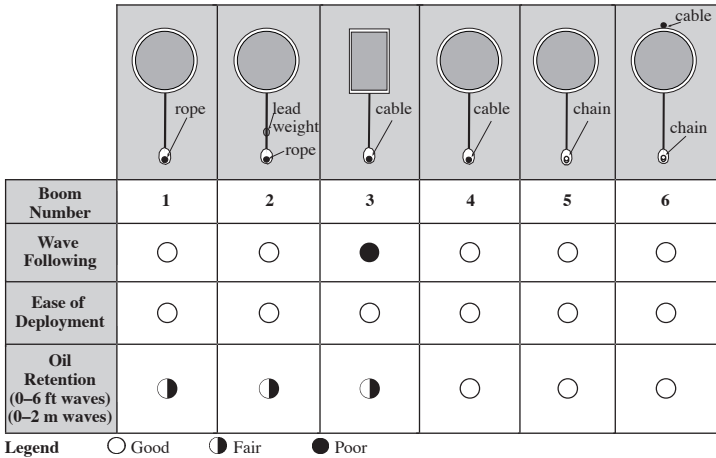

Figure 5-7 Internal Foam Flotation Boom

The advantages and disadvantages of this boom type, as numbered above, are shown below.

Boom Number	Advantages	Disadvantages
1	<ul style="list-style-type: none"> • Lightweight when no ballast used 	<ul style="list-style-type: none"> • More likely to fail without additional strength members (bottom rope is a strength member)
2	<ul style="list-style-type: none"> • Lead weights less likely to corrode during long immersions • Better roll response with lead ballast 	<ul style="list-style-type: none"> • Holes in fabric where lead weights are attached may be failure points
3	<ul style="list-style-type: none"> • Rectangular float can be bent on a small reel 	<ul style="list-style-type: none"> • Poor wave following
4	<ul style="list-style-type: none"> • Strong due to cable for strength and ballast • Better roll and heave response than rectangular flotation 	
5	<ul style="list-style-type: none"> • Chain gives strongest tension member and heaviest ballast 	
6	<ul style="list-style-type: none"> • Top cable gives more stability and added strength in currents 	

5.7.1.1 General Comments

- Internal foam flotation boom is generally the most widely used and available boom.
- PVC or polyurethane-coated fabric encloses flexible foam flotation.
- Ballast and tension members may be enclosed within the fabric.
- Durability varies depending on the material and strength of the fabrics.

5.7.1.2 Recommended Use

- Use for containment of oil or deflection of slicks in low currents (<1 kt or 0.5 m/s).
- Select for use where adequate boom storage facilities are available. Most models are normally stored in containers or on the deck of boom deployment vessels although, in some cases, larger diameter reels are also used.
- Generally, terminal facilities and marinas can be protected using this type of boom.
- Extended deployment (several weeks) in waves up to 3 ft (1 m) is feasible.

5.7.1.3 Operational Considerations

- In areas where currents are more than 0.5 kts (0.25 m/s), select round flotation booms with top and bottom tension members for deflecting and containing slicks.
- In slower currents (<0.5 kts or 0.25 m/s), round flotation booms with only a bottom tension member can be used for deflection/containment.
- In quiet, shallow water, it is reasonable to expect that booms with square or rectangular internal flotation can be successfully used.
- Long lengths of boom (several hundred feet) can be deployed, which can sustain loads usually encountered during most nearshore operations.
- The bottom chain pocket could abrade if deployment is conducted from concrete boat ramps, dock surfaces and roadways.
- High durability fabrics such as polyester, nylon or aramid should be selected for permanent booming applications.
- Straight-line towing (streaming) is possible at low speeds (up to 0.5 kts or 0.25 m/s) to the location of use.

5.7.2 Self-Inflating Boom

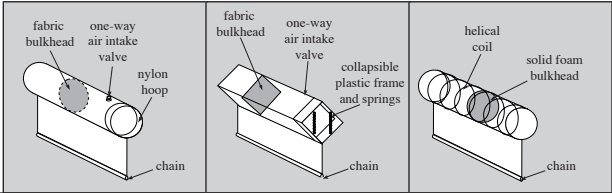

Boom Number	1	2	3
Wave Following	○	○	○
Ease of Deployment	○	○	○
Oil Retention (0-4 ft waves) (0-1.2 m waves)	○	○	○

Legend ○ Good ◐ Fair ● Poor

Figure 5-8 Self-Inflating Boom

The advantages and disadvantages of this boom type, as numbered above, are shown below.

Boom Number	Advantages	Disadvantages
1	<ul style="list-style-type: none"> Sealed compartments Can be compacted on racks or pallets 	<ul style="list-style-type: none"> Cannot be reeled Splashover due to round freeboard without fin Oil in the air valve could prevent it from functioning If a valve malfunctions, that section can lose buoyancy
2	<ul style="list-style-type: none"> Can be reeled and packed on pallets Most compactible of all three types Sealed compartments 	<ul style="list-style-type: none"> Loses freeboard due to water and wind forces turning the square freeboard on its side Internal springs present maintenance problem Oil in the air valve could stop it from functioning Repacking is difficult due to need to extend springs
3	<ul style="list-style-type: none"> Stores on reel Simple to use No valves, only air ports 	<ul style="list-style-type: none"> Water can pass from one compartment to the next over the air slot in the bulkhead

5.7.2.1 General Comments

- Self-inflating boom is excellent for handling and storage, and it is quickest to deploy.
- PVC or polyurethane-coated fabric contains flotation chambers that compress during storage and inflate with air through intake valves upon deployment.
- Built-in frames, springs, or helical metal coils can assist self-inflation.
- Fabrics have relatively high tensile strength, but can be punctured by debris or other sharp objects, thereby resulting in loss of buoyancy.
- Fabric tearing during deployment can also result in loss of buoyancy.
- Long-term problems, such as corrosion and collapse, have occurred with various internal expansion mechanisms.
- This boom is well-suited for air transportation to remote locations.
- This boom conforms well to waves.

5.7.2.2 Recommended Use

- This type of boom is designed for rapid deployment situations.
- This boom type has been used for stationary containment or deflection of slicks in calm, low currents and nearshore waters, i.e., in harbors and at other sites with wave heights of up to 3–4 ft (1–1.2 m) and currents up to 0.5 kts (0.25 m/s).
- Self-inflating boom may be suitable for use at facilities or on vessels with limited storage space and on compact reels (some boom models only).

5.7.2.3 Operational Considerations

- When deployed, each section must be fully extended so that the boom has sufficient flotation towards connectors to keep them at full freeboard.
- Limit single deployment to lengths of 500–1,000 ft (150–300 m).
- Plan to monitor and tend frequently once deployed to ensure that flotation is maintained.

5.7.3 Pressure-Inflatable Boom

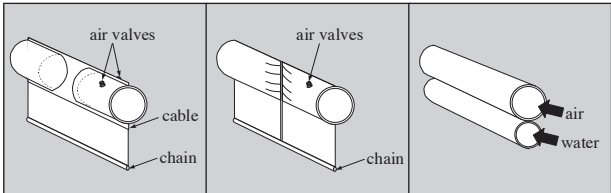

Boom Number	1	2	3
Wave Following	○	○	○
Ease of Deployment	◐	◐	○
Oil Retention (0-6 ft waves) (0-2 m waves)	◐	○	◐

Legend ○ Good ◐ Fair ● Poor

Figure 5-9 Pressure-Inflatable Boom

The advantages and disadvantages of this boom type, as numbered above, are shown below.

Boom Number	Advantages	Disadvantages
1	<ul style="list-style-type: none"> • Divided air cylinders result in only partial loss of freeboard if the boom is punctured • Can be deployed manually • Can be reeled 	<ul style="list-style-type: none"> • Slow to deploy due to each half cylinder having to be inflated separately
2	<ul style="list-style-type: none"> • A single large air cylinder decreases inflation time • Can be reeled 	<ul style="list-style-type: none"> • Puncture causes total loss of freeboard in section of boom • Heavy to deploy, recovery requires winch
3	<ul style="list-style-type: none"> • A reel deployment and recovery system makes this boom easy to deploy and recover • Some versions have an air manifold on top of flotation and check valves in segments so continuous air compressor is not required • Excellent shore seal 	<ul style="list-style-type: none"> • No bottom tension member • Requires powered reels to recover boom • Needs continuous power for air compressor and water pump while deployed • Puncture causes total loss of boom • Very difficult to re-position once lower boom has been filled with water

5.7.3.1 General Comments

- Pressure-inflatable boom allows for compact storage and high buoyancy to weight ratio.
- Well suited for air transportation to remote locations.
- Fabric is PVC, neoprene, nitrile rubber-nylon, or polyurethane-coated material.
- Up to several hours might be required to inflate sections of some open water models. Other protected water models inflate much more quickly.
- Durable fabrics are now generally used in this boom type versus earlier models.

5.7.3.2 Recommended Use

- For coastal and offshore operations for both stationary and towed boom configurations.
- For use where storage space is limited. Compact reel storage is possible.
- For use when fast deployment and retrieval are not priorities.
- For situations where wave heights can reach 6 ft (2 m).
- For use where wave conformance is a priority.
- Pressure-inflatable boom is generally not suitable for deployments longer than 1 week due to the potential loss of air; more durable models are exceptions.

5.7.3.3 Operational Considerations

- On-site air blower and power supply are required for inflation.
- Plan on sufficient working platform that can accommodate boom, auxiliary equipment, and adequate personnel.
- Monitor and tend frequently once deployed to ensure that flotation remains intact.
- Large models require a mechanized handling system and an adequate number of personnel for deployment and recovery.
- Some manufacturers offer a non-standard piano hinge connector that may cause problems when (1) the hinge is bent or (2) the boom must be connected to other booms.

5.7.4 Fence Boom

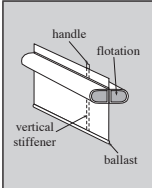
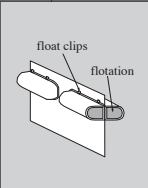
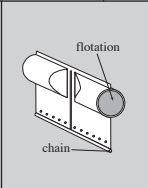
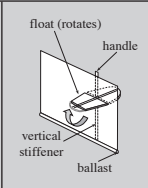
				
Boom Number	1	2	3	4
Wave Following	●	●	●	●
Ease of Deployment	○	○	●	○
Oil Retention (0-2 ft waves) (0-0.6 m waves)	○	○	○	○

Legend ○ Good ● Fair ● Poor

Figure 5-10 Fence Boom

The advantages and disadvantages of this boom type, as numbered above, are shown below.

Boom Number	Advantages	Disadvantages
1	<ul style="list-style-type: none"> • Heavy materials all molded • Good roll response 	<ul style="list-style-type: none"> • Low buoyancy to weight ratio • Poor wave (heave) response • Difficult to deploy and recover
2	<ul style="list-style-type: none"> • Replaceable floats • Good roll response 	<ul style="list-style-type: none"> • Poor wave (heave) response • Difficult to deploy and recover • Not good in debris since floats may be dislodged
3	<ul style="list-style-type: none"> • Lightest of fence type boom • Replaceable floats • Fairly easy to deploy 	<ul style="list-style-type: none"> • Poor wave (heave) response • Only fair roll response
4	<ul style="list-style-type: none"> • Wide floats give good resistance to roll in models 3 ft (1m) in total height or less • Boom can be inverted in water to remove marine growth 	<ul style="list-style-type: none"> • More subject to float damage and hanging up on piers, boats, etc. • Poor wave (heave) response • Difficult to deploy • Floats may retain debris

5.7.4.1 General Comments

- Fence boom with rigid or semi-rigid fabric provides a vertically stiff and horizontally flexible “fence”.
- Flotation is provided by integrated-foam flotation blocks, bolted-on blocks, or outrigger floats.
- Fabric durability ranges from low to high tensile strength options, depending on intended application.
- Fence boom provides effective, long-term, low maintenance protection and/or containment.
- Some models are suitable for long-term/permanent deployment in harbors to surround vessels transferring petroleum products.
- External floats on some models may create additional water surface disturbance resulting in increased oil entrainment or splashover.

5.7.4.2 Recommended Use

- For routine or permanent deployment situations.
- Fence boom is applicable to stationary containment of oil in quiet waters or deflection of slicks in low currents of 0.5 kts (0.25 m/s). It is only suitable for low wave height.
- Use at facilities or on vessels with sufficient boom storage space.
- Fence boom is generally suitable for the protection of terminal facilities and marinas. It is sometimes used for the nearshore containment and concentration of slicks for recovery.
- Use where debris resistance is required.
- Use during extended deployment periods of several weeks or more.

5.7.4.3 Operational Considerations

- Fence boom can be towed at low speeds (up to 5 kts or 2.6 m/s) to location of use.
- Long lengths of boom (600 to 800 ft or several hundred meters) can be deployed which can sustain loads usually encountered during nearshore operations.

5.8 Boom Deployment

Before boom is deployed, the approximate length of boom required should be assembled as completely as possible either on land or on the deck of a boat. Suggested lengths of booms for various applications are presented in Table 5-5.

Table 5-5 Suggested Boom Lengths

Application	Type of Boom	Quantity
Circle a stricken vessel	Offshore or harbor, depending on sea conditions	3 x ship's length
Contain leakage from terminal operations	Calm water or harbor, depending on sea conditions	1.5 x ship's length
Use with an ocean skimmer	Offshore	500-1,500 ft (460-610 m) per skimmer
Protect entrance to estuary, stream, river, etc.	Calm water	3 to 4 x width of a water body
Bays, harbors, marshland	Calm water or harbor, depending on sea conditions	(1.5 + current in kts) x width of a water body

It is important to ensure that all boom connectors are compatible, especially when booms from multiple manufacturers are used. When ordering booms, always ensure that connectors meeting ASTM standard specification F962 are used. This will ensure that all booms can be connected to each other even if they are from different manufacturers. Check local contractors or Oil Spill Response Cooperatives to determine what type of connector is used.

Once the boom is ready, it can be launched and towed into position by boat. To ease the problems for a towing boat, a long boom can be doubled back on itself and towed out from the center point. Once that is anchored, the ends can then be towed into place and anchored. Final configuration can be arranged by setting suitable anchors or securing to permanent anchor points.

Where a boom is being used to collect oil at a shore location or protect a sensitive area, care should be taken to seal the shore end of a boom so that no oil can escape. This is particularly difficult in tidal waters and at sites where the shore is rocky or strewn with boulders and crevices.

Boom length may have to be modified after the boom has been deployed. This can be difficult to do from a vessel particularly in strong currents, high winds, or low temperatures as loose shackles, bolts, and tools can be lost over the side. Often, boom length cannot be changed once the boom is in the water, and the boom must be retrieved, reconfigured, and re-deployed.

5.8.1 BoomVane™

A BoomVane™ (Figure 5-11) is a device for deploying containment boom or dispersant spray arms into bodies of water by harnessing the power of currents in the waterway. The device can be launched from a boat or from land. When deployed from a boat, the BoomVane™ allows for a single vessel sweep system without the need for an outrigger arm. Using a series of lines, the device can be launched and retrieved which allows for quicker repositioning when needed due to debris, vessel traffic, or changing tides.

Available in four different sizes, ranging from the 0.5m Shallow, 1.0m Standard, 1.5m BoomVane™, to the largest—2.0m Ocean.

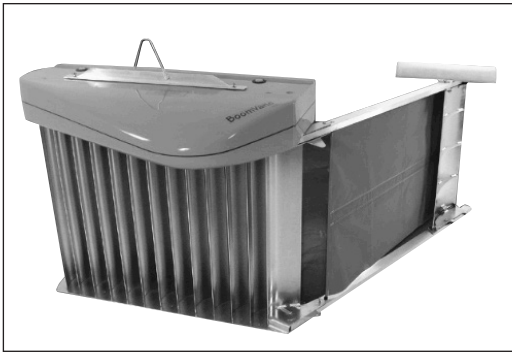

Figure 5-11 BoomVane™

5.9 Guidelines for Towing Boom

Boom is pulled by towboats in various configurations to contain and recover slicks. Boat speed is typically less than 1 knot (0.5 m/sec).

5.9.1 U-booming

Two vessels can tow a boom in a U-configuration by drifting downstream, holding in a stationary position, or by moving upstream toward the spill source.

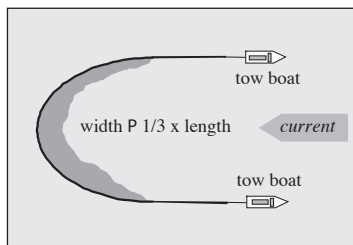

Figure 5-12 U-Booming

5.9.2 V-booming

Boom can be deployed in a V-configuration using three vessels and a skimmer. A tie-in is usually needed to maintain the V shape.

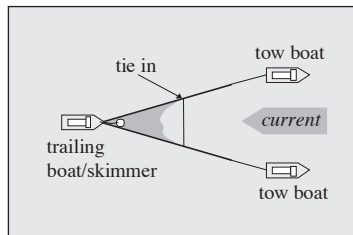

Figure 5-13 V-Booming

5.9.3 J-Booming

Boom can be towed in a J-configuration that will divert oil to a skimmer to allow simultaneous containment and recovery.

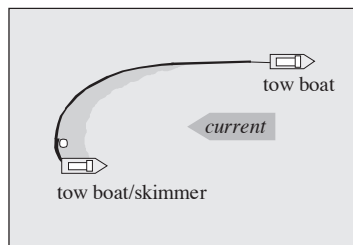

Figure 5-14 J-Booming

Table 5-6 shows the applicability of boom towing configurations for the four basic boom types in calm, protected, and open water.

Table 5-6 Boom Towing Configuration

Boom Use		Internal flotation	Pressure-Inflatable	Self-inflating	Fence
Calm Water	U/V	◐	○	◐	●
	J	○	○	●	◐
Protected Water	U/V	○	○	◐	●
	J	○	○	●	◐
Open Water	U/V	◐	○	●	●
	J	○	○	●	●

Legend ○ Good ◐ Fair ● Poor

Boom lengths of 500 to 1500 ft (150 to 460 m) are typically used when towing boom in a U, V, or J configuration to maximize the oil encounter rate. Lengths as high as 2000 ft (600 m) have been used but maneuverability is improved with shorter boom lengths.

The use of proper towing bridles or paravanes will minimize damage during towing by efficiently transferring the point load tension from the line to the connector. Towing devices prevent a boom from twisting when being towed at high speeds. Lines between boom ends and vessels should be of sufficient length to avoid sharp stress or snatching on a towed boom. Approximately 200 ft (60 m) for a 1,500 ft (460 m) length of boom is typical. When feasible, an odd number of boom sections should be used to avoid having a connector at an apex from which oil more readily escapes.

Oil concentration by towed booms can be slow in thin slicks. Boom performance can be judged visually at the apex of the U or J. Oil lost under a boom will appear as globules or droplets rising from behind a boom. Eddies behind a boom are also an indication that towing is too fast; however, sheens are usually present behind a boom even when a boom is functioning well.

Note that the apex of a boom often cannot be seen from the wheel-houses on towing vessels. Aircraft equipped with suitable air-to-sea communications can assist in directing movements and activities of vessels to ensure that they are operating in the heaviest concentrations of floating oil. Oil slicks can be more easily located from the air than from the water surface. The thickness and volume of a slick can also be estimated from an aircraft.

Maintaining proper station of the two towing vessels relative to one another requires good communication and is improved with practice. Towing in a J configuration is difficult with untrained crews. For maximum maneuverability at low speeds, the ideal towing point aboard the vessel must be determined by trial and error and may need to be altered according to wind and course direction. A towing point well forward of the stern is best.

5.10 Special Application Boom

5

5.10.1 Shore-Sealing Boom

In intertidal areas, or along river banks, where water levels fluctuate, shore-sealing booms can be deployed to ensure that a seal is maintained at the waterline. They can be used on mud or sand flats, but do not form an effective seal on either rough or rocky shorelines.

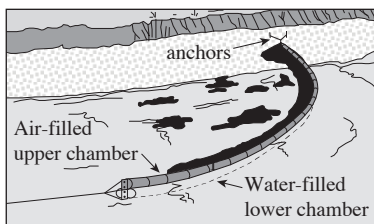

Figure 5-15 Shore-Sealing Boom

5.10.2 Netting Boom

Subsurface barriers are used to intercept, contain, and/or recover oil that is below the water surface. They are generally used to recover heavy oils, such as weathered or emulsified crude, tar balls, or tacky burn residue. They will not recover light, low viscosity oils that can flow through the boom's mesh.

Netting boom can usually be towed at higher speeds than conventional boom, which may allow higher recovery rates, better steering control and continuous operation of the tow vessel (i.e., the vessel can maintain its speed without stopping and starting).

Netting boom is suitable for collecting oil along beaches and shorelines with significant wave action. This type of boom may be set just below the high tide line to catch any weathered oil or emulsion that floats ashore, preventing the oil from penetrating into the soil below. The netting can be retrieved, cleaned, and reapplied before the next tidal cycle, or it can be incinerated. Note that retrieval and cleaning of oiled netting is a messy task that often requires subsequent cleaning of vessels and crew. Incineration may require government approval and/or use of an approved incinerator.

5.10.3 Current Buster® Technology

Conventional containment boom tow speed is limited due to entrainment failure that generally occurs at current speeds between 0.7 and 1.0 knots (0.4-0.5 m/s) as described in Section 5.4 Boom Failure. Current Buster® technology is able to increase the speed at which oil can be corralled to up to 5 knots towing speed with minimal oil loss. The system consists of two boom lengths extending outward to create a pocket (i.e., swath width), a debris collection area, and then a set of wave dampeners directly ahead of a pocket for oil collection, thickening, and pumping. This technology is available in multiple sizes which are constructed for specific areas of operation (i.e., nearshore, offshore and open water).

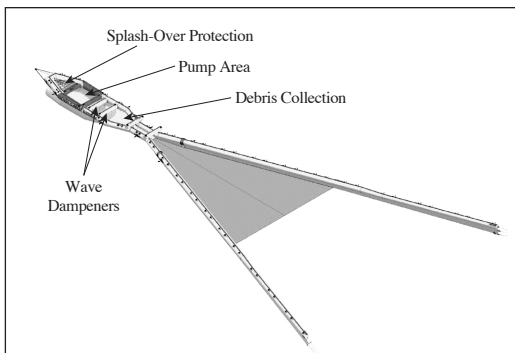

Figure 5-16 General Current Buster® Configuration

5.11 Boom Anchoring

Anchoring boom requires specific knowledge of the equipment, accessories, and techniques involved. Tide tables, local knowledge and weather forecasts should be consulted before boom is deployed, especially when it must remain overnight.

- Anchoring boom can require anchors (e.g., Danforth, Fisherman's), release lines, chains, floats, bridles, lights, and other accessories (see Figure 5-16).
- If feasible, permanent anchors can be placed at strategic sites in advance of a spill.
- Table 5-7 can be used to approximate anchor size. Local mariners can also provide guidance.
- Practice drills can help determine the type and weight of anchors most effective at specific sites.

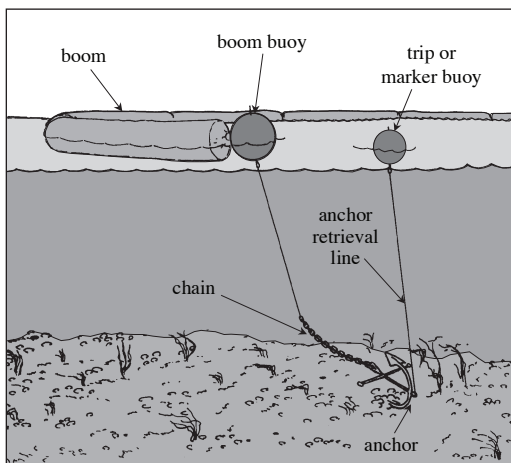

Figure 5-17 Boom Anchoring Assembly

Table 5-7 Holding Strength of Danforth Anchors

Anchor Weight lbs (kg)		Holding Strength					
		Mud		Sand		Clay	
30	(15)	440	(200)	550	(250)	660	(300)
60	(25)	770	(350)	880	(400)	1,100	(500)
80	(35)	1,320	(600)	1,540	(700)	1,540	(700)

5.11.1 Anchoring in Marine Waters

The following guidelines should assist in preventing the loss or damage of boom anchors in coastal waters:

- For large boom and many containment operations in currents, it is essential to set anchors first, and then deploy and attach boom to ensure correct positioning. Smaller boom (<18 in or < 46 cm) can be easily deployed in calm water by anchoring either first or last.
- Anchor lines can be fastened directly to towing ends. If anchor buoys are used, they should be securely fastened to anchor lines.
- When booms without anchoring points are deployed, floats provide an effective means of attachment so that the boom is not pulled down with tide changes.
- When anchor points are located below the water surface, a floating line should be attached to allow ready access.
- To assist in retrieving an anchor, a trip (or marker) line can be attached to the crown of an anchor that is secured at its other end to a float of a different color than the anchor line buoy.
- Consistent color and size, e.g., 8 in (20 cm) blue top line buoys and 12 in (30 cm) red anchor line buoys, facilitate the deployment and retrieval of boom.

In non-flowing waters, boom should be anchored every 200 ft (60 m), noting the following:

- Tides and boom configuration might dictate more frequent anchoring intervals.
- The length of anchor lines (L) can be estimated using the following formulas:
 - calm water: $L = 3 \times \text{water depth}$
 - choppy water: $L = 5 \times \text{water depth}$
 - rough water: $L = 7 \times \text{water depth}$

- In waves along exposed coasts, anchor lines should be at least 5 x the water depth to prevent them from snatching (i.e., being quickly pulled under the water surface when placed under tension).
- Generally, the length of line used should include sufficient slack to allow for tides, currents, and waves. This length is assessed on a case-by-case basis.
- Chain can be attached to an anchor line at its end to help set the anchor and to increase its holding capacity.

5.11.2 Anchors of Opportunity

5

The number of anchors available during a large spill incident is often limited. As a result many anchors of opportunity are used. Examples of anchors of opportunity include concrete blocks, metal weights and a shore sealing (air/water tube) boom.

- Lines should be firmly attached to such anchors and safe deployment procedures carefully followed so that mishaps do not occur.
- Lifting gear for concrete blocks and other large weights should be used properly, in a manner that does not compromise the stability of a small vessel, e.g., tugboat.

5.11.3 Anchoring in Currents

Deploying boom in currents of 0.5 kts (0.25 m/s) or more requires special anchoring techniques:

- Lines can be secured to shore every 30 ft (10 m) to allow the boom to be angled 30° to 45° to the current and to reduce the effective current velocity acting on the boom. Oil can then be deflected or recovered.
- Cables or ropes can be used to link boom to various anchors located on a riverbank or foreshore area.
- Trees, bridge supports, and other items can be used to anchor boom, often at pre-selected spill control points, as long as they don't represent unsafe tripping hazards. Cables or rope can be covered by rubber or run through small floats so that neither the line nor the item used as an anchor is damaged.
- At some river terminals, a boom can be permanently anchored at one end and left to float freely in the water. When needed, usually to surround a vessel transferring oil, the free end of a boom can then be readily towed into position.

5.12 Boom Washing

There is little need to wash booms used to trap oil repeatedly. However, it is necessary to clean boom under certain circumstances:

- Where boom is to be used for the protection of un-oiled areas;
- After boom has been used to contain oil freed during shoreline cleanup operations; and
- When boom is taken out of service and returned to storage.

Use of dirty boom is usually unacceptable because of the sheen it leaves behind. Cleaning small amounts of boom can be done manually in a contained area using a pressure washer wand, long handled-scrub brushes, detergent, and warm water. A containment area is necessary where the wash water is collected. After washing, booms can be wiped by hand with sorbent pads. On a good day, 6 to 12 workers can clean up to 3,000 ft (900 m) of boom.

In the event of imminent bad weather, more rapid cleanup techniques such as dispersants or shoreline cleaners may be useful options, if there is government support.

5.13 Material Take Off (MTO) List

Typical equipment needed is shown in the following MTO list.

Table 5-8 Material Take Off List for Boom

Equipment	Use
Boom	Containing oil for recovery
Anchors	Anchoring boom
Floats	Marker and trip-line buoys
Rope	Towing, anchoring
Paravanes	High-speed towing
Chain	Anchoring
Cable	Towing, positioning boom
Lights	Night-time illumination of boom
Fittings	Connecting boom, lights, anchor lines
Power supply/generator	Provide power for air blowers, pumps, etc.
Air blowers	Filling air chambers on inflatable boom
Pumps	Filling water chambers on shore-sealing boom
Vessels	Deploying, towing, and tendering boom
Aircraft	Slick spotting, positioning of vessels
Radios	Communication among vessels/aircraft
GPS	Positioning boom, documenting activities
BoomVanes™	Deploying and retrieving containment boom
Current Busters®	Increases tow speed of boom while maintaining containment characteristics

6 Shoreline Protection

6.1 Introduction

Every reasonable effort should be made to prevent oil from reaching the shore in order to reduce:

- Environmental impacts
- Duration of cleanup operations
- Generated wastes

If attempts to do so fail, methods to divert slicks from a more sensitive area to a less sensitive area should be employed. This section discusses various ways of keeping oil away from sensitive areas and identifies shoreline protection measures.

If oil has reached the shore, the treatment techniques outlined in Section 12 should be considered.

6

6.2 Shoreline Types

Response strategies have been developed for the various shoreline types based on their specific characteristics. The sensitivity of each shoreline type to spilled oil is indicated in Table 6-1. The shoreline types are arranged from lower sensitivity (e.g., exposed rocky headland) to higher sensitivity (e.g., salt marshes and mangroves). Near-shore habitats, such as kelp and seagrass beds, coral reefs and lagoons are included in Table 6-1 because these areas warrant special consideration in deploying protective measures.

Table 6-1 Response Considerations for Various Shoreline Types and Nearshore Habitats

Intertidal Shoreline	Response Considerations
Exposed Rocky Headlands and Wave-cut Platforms	<ul style="list-style-type: none">• Wave reflections can help to keep oil offshore• Cleanup may not be required
Man-made Solid Structures and Boulder Beaches	<ul style="list-style-type: none">• Wave swept, usually erosional• Natural processes will remove oil within weeks• Cleanup may not be required
Fine- to Medium-Grained Sand Beaches	<ul style="list-style-type: none">• Low density of biological populations• Oil does not penetrate into the beach• Mechanical removal of oiled sand is effective

Table 6-1 Response Considerations for Various Shoreline Types and Nearshore Habitats (continued)

Intertidal Shoreline	Response Considerations
Coarse Grained Sand Beaches	<ul style="list-style-type: none"> • Low density of biological populations • Oil may penetrate/be buried rapidly up to 30 cm, making cleanup difficult • Mechanical removal is effective
Tundra Cliffs	<ul style="list-style-type: none"> • Vegetation overlies peat and permafrost • Remove oil by sorbing with peat or by other manual methods
Gravel and Cobble Beaches	<ul style="list-style-type: none"> • Oil may penetrate rapidly, making cleanup difficult • Cleanup should concentrate on high tide area • Oiled debris should be removed (ideally, debris should be removed prior to oil impact) • Shoreline cleaners used in some countries to speed oil removal
Riprap	<ul style="list-style-type: none"> • Mainly breakwaters and jetties • High pressure flushing may be effective • Any released oil must be recovered
Exposed Tidal Flats	<ul style="list-style-type: none"> • Low to moderate biomass • Mobile sediments, and most oil will not penetrate sediments • Natural processes will remove most oil in about one year
Exposed Vegetated Tidal Flats	<ul style="list-style-type: none"> • Moderate biomass • Sediments less mobile, and most oil will not penetrate sediments • Oil may persist about one year
Sheltered Rocky Shores and Clay Scarps	<ul style="list-style-type: none"> • Moderate to high biomass may be affected • Clay scarps may have numerous burrows and tunnels • High priority protection zones • Removal of heavy oil concentrations may be beneficial; use only low-pressure flushing
Peat Shorelines	<ul style="list-style-type: none"> • Often found in Arctic regions • Natural recovery is the most preferred response option
Inundated Lowland Tundra	<ul style="list-style-type: none"> • These are Arctic subsidence areas flooded by the sea • Cleanup can cause extensive damage • Natural recovery is least damaging and preferred

Table 6-1 Response Considerations for Various Shoreline Types and Nearshore Habitats (continued)

Intertidal Shoreline	Response Considerations
Sheltered Tidal Flats	<ul style="list-style-type: none"> • Large populations of animals and plants • Area should receive top priority protection from oil contact • Low wave action • Removal of heavy oil accumulation may be beneficial; otherwise, cleanup is not recommended • Oil may persist for long periods
Salt Marshes	<ul style="list-style-type: none"> • Most productive of aquatic environments • Very low wave energy, and high sedimentation rate incorporates oil into sediment • Oil may persist for years • Cleanup may do more damage than natural degradation processes
Mangroves	<ul style="list-style-type: none"> • One of the most important marine habitats • Highest priority protection area • Mangroves should not be altered by response activities • Dispersants or cleaners can be more beneficial than mechanical cleaning
Shallow Subtidal	Response Considerations
Coral Reefs and Lagoons	<ul style="list-style-type: none"> • Areas should receive high protection priority • Oil will float over reefs with minimum impact • Dispersants may be used near but not above coral reefs
Seagrass Beds	<ul style="list-style-type: none"> • Highly productive aquatic environment • Low wave action • Oil will float over • Cleanup may do more damage than leaving the oil to natural degradation processes
Kelp	<ul style="list-style-type: none"> • Highly productive aquatic environment • Will not be impacted by floating oil • Dispersants should not be applied directly above

Reference: ASTM F-2464-12, *Standard Guide for Cleaning of Various Oiled Shorelines and Sub-Tidal Habitats*, ASTM International, West Conshohocken, PA, USA, 2012.

6.3 Selection of Shoreline Protection Techniques

Selection of an appropriate protection technique for a shoreline depends not only on the type of shoreline and its sensitivity, but also on several other factors as summarized in Table 6-2.

Table 6-2 Factors Affecting Shoreline Protection

Nature of the Spill	<ul style="list-style-type: none">• Amount and type of oil spilled• Time until oil contacts shore
Weather	<ul style="list-style-type: none">• Present conditions• Weather forecasts
Type of Water Body	<ul style="list-style-type: none">• Lake, river, canal, swamp, lagoon, estuary, ocean, fjord, bay, strait, etc.
Ecological, Economic, and Cultural Resources	<ul style="list-style-type: none">• Immediate risk to resources• Seasonal considerations (nesting, spawning, ice, snow)• Fishing, tourism
Water Movement	<ul style="list-style-type: none">• Erosional or depositional (high or low flow) in nature• Current speed and direction, rip tide• Tidal action: differential, frequency, tidal bore• Wave action: breaking, non-breaking
Shoreline Contour	<ul style="list-style-type: none">• Water depth• Smooth, rocky, reef, island• Precipice, shelf, harbor,• Gradient, stability of sediment
Accessibility	<ul style="list-style-type: none">• Land access (roads rated for passage of heavy equipment)• Water access (depth greater than boat draft and ability to operate in slick)• Air access (flat ground with <math><10^\circ</math> slope for helicopter pad)

6.4 Shoreline Protection Decision Guides

Decision guides are presented in this section to facilitate the selection of shoreline protection techniques for particular spill conditions and the waterway or shoreline type and contour involved.

The decision guides in this section are divided into two categories:

- Inland waterways (Table 6-3)
- Coastal waters and large lakes (Table 6-4)

Information on response techniques applicable to a particular type of waterway are summarized below.

Table 6-3 Decision Guide for Protecting Inland Waterway Shorelines

<p>Lake or Pond</p>	<p>Minor sheen</p> <ul style="list-style-type: none"> • Use sorbent boom <p>Moderate to major visible slick</p> <ul style="list-style-type: none"> • Use containment boom
<p>Rivers or Large Streams >1.6 ft (0.5 m) deep</p>	<p>Currents <1 kt (0.5 m/s)</p> <ul style="list-style-type: none"> • Use containment or exclusion boom <p>Currents 1–2 kts (0.5–1.0 m/s)</p> <ul style="list-style-type: none"> • Use single diversion boom <p>Currents >2 kts (1.0 m/s)</p> <ul style="list-style-type: none"> • Use cascading or fast current boom
<p>Small Streams <33 ft (10 m) wide and 1.6 ft (0.5 m) deep</p>	<p>Currents <1 kt (0.5 m/s)</p> <ul style="list-style-type: none"> • Use sorbent or containment boom or berms or dams <p>Currents 1–2 kts (0.5–1.0 m/s)</p> <ul style="list-style-type: none"> • Use single diversion boom or berms or dams <p>Currents >2 kts (1.0 m/s)</p> <ul style="list-style-type: none"> • Use cascading boom, fast current boom or berms or dams
<p>Shallow Rivers or Streams <1.6 ft (0.5 m) deep</p>	<p>Currents 0–2 kts (0–1.0 m/s)</p> <ul style="list-style-type: none"> • Use berms or dams

Table 6-4 Decision Guide for Protecting Coastal Shorelines

<p>Straight Coastline with Sensitive Areas</p>	<p>Breaking waves >1.5 ft (0.5 m)</p> <ul style="list-style-type: none"> • Use beach berm or containment boom outside of surf zone if feasible <p>Breaking waves <1.5 ft (0.5 m)</p> <ul style="list-style-type: none"> • Use diversion boom upstream of sensitive areas
<p>Entrance to Bays, Harbors, Lagoons</p>	<p>Breaking waves <1.5 ft (0.5 m) <i>and</i> current <1 kt (0.5 m/s)</p> <ul style="list-style-type: none"> • Use exclusion boom across entrance <p>Breaking waves <1.5 ft (0.5 m) <i>and</i> current >1 kt (0.5 m/s)</p> <ul style="list-style-type: none"> • Use angled diversion boom at or inside entrance where currents are reduced <p>Breaking waves >1.5 ft (0.5 m)</p> <ul style="list-style-type: none"> • Use containment boom outside of entrance
<p>Narrow Tidal Channel</p>	<p>Current <1 kt (0.5 m/s)</p> <ul style="list-style-type: none"> • Use sorbent barriers or exclusion boom across entrance <p>Current >1 kt (0.5 m/s)</p> <ul style="list-style-type: none"> • Use diversion boom across channel

Note: When wave amplitude exceeds 1.5 ft (0.5 m) or currents exceed 3 knots (1.5 m/s), protective booms should be moved to calmer waters if available. It will be very difficult for a single boom to contain oil.

6.5 Specific Protection Measures

Physical protection techniques that can be used to control or contain floating oil slicks are described in the sections below. Four booming techniques, two earthen barrier types, and use of a passive, sorbent boom are presented below.

6.5.1 Exclusion Booming

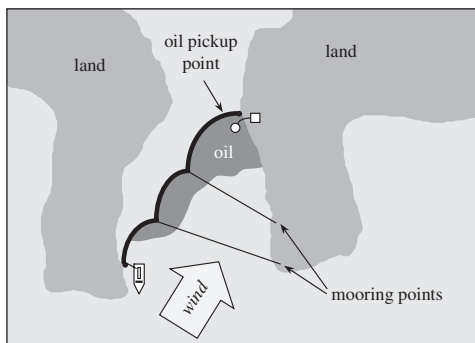

Figure 6-1 Exclusion Booming

Description	Boom is deployed across or around sensitive areas and anchored in place. Approaching oil is deflected or contained by boom.
Primary Uses	Across small bays, harbor entrances, inlets, river, and creek mouths with: <ul style="list-style-type: none">• Currents <1 kt (0.5 m/s)• Breaking waves <1.5 ft (0.5 m) high
Environmental Effects	Minor disturbance to substrate at shoreline anchor points
Logistics	For calm weather, light boom: <ul style="list-style-type: none">• Workboat plus crew• 6 anchors plus anchor line and buoys• 1 recovery unit (including skimmers, transfer and storage) For rough weather, heavy boom: <ul style="list-style-type: none">• Workboat plus crew• 12 anchors plus anchor line and buoys (recovery not possible)

6.5.2 Diversion Booming

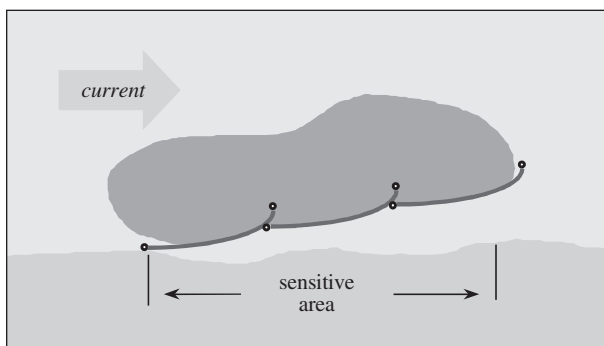

Figure 6-2 Diversion Booming

6

Description	Boom is deployed at an angle (see 5.4.1) to the approaching slick. Oil is diverted away from the sensitive area to a less sensitive location for recovery.
Primary Uses	<ul style="list-style-type: none"> • Inland streams with currents >1 kt (0.5 m/s) • Across small bays, harbor entrances, inlets, river and creek mouths with currents >1 kt (0.5 m/s) and breaking waves <1.5 ft (0.5 m) • On straight coastline areas to protect specific sites, where breaking waves <1.5 ft (0.5 m)
Environmental Effects	<ul style="list-style-type: none"> • Minor disturbance to substrate at shoreline anchor points • Diverted oil may cause heavy shoreline oil contamination downwind and down current.
Logistics	<p>For single boom:</p> <ul style="list-style-type: none"> • Workboat plus crew • 1 anchor plus anchor line <p>For cascading boom:</p> <ul style="list-style-type: none"> • Workboat plus crew • 6–9 anchors plus anchor line and buoys

6.5.3 River Booming

Various commercially available booms have been specially designed for operation in rivers. River booms include both top and bottom tension members that provide vertical stability and improved oil deflection capability in relatively high current, i.e., up to approximately 2–3 kts (1–1.5 m/s). Such booms can be effective in a river where there is uni-directional flow. In a large coastal river with reversing tides, repositioning a boom can be difficult and time-consuming.

When current speeds exceed 0.75 kt (0.4 m/s), it is necessary to angle the boom (including river booms) to reduce the current relative to the boom. Angling the boom also allows oil to be diverted to shore where it can be collected. (See also Section 5.4.1)

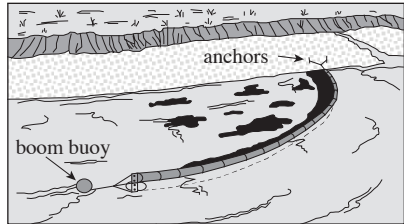

Figure 6-3 River Booming

6.5.4 Shore-Sealing Boom

Shore-sealing boom has water-filled lower and air-filled upper chambers that automatically adjust to changing water levels (Figure 6-4). The shore-end (stranded end) of the shore-sealing boom is fixed while the water-end (floating end) floats and is usually connected to a conventional boom.

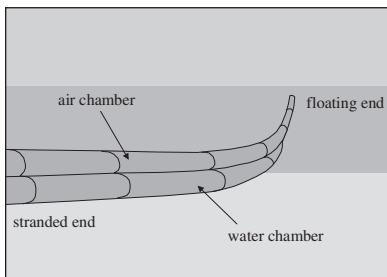

Figure 6-4 Shore-Sealing Boom

When deploying shore-sealing boom, the final position should be known before the boom is placed and anchored since redeployment is difficult, if not impossible, once the heavy water-filled chambers have settled on the shore. The water chambers of the boom must be fully filled or water will collect in the lower sections leaving the more highly elevated sections (toward the shore) only partially full or empty. However, on beaches with severe slope towards the water, shore-sealing booms can be damaged from stress on the waterside end connector if too much water is used.

Sites with boulders, sharp protrusions, riprap, or other features that will result in oil leaking under the boom when the tide changes should be avoided. Once deployed, shore-sealing booms require regular monitoring since currents, wind, and waves can move and/or twist them. Damage to fabric can result as a boom grounds and chafes in an intertidal zone.

6.5.5 Beach Berms

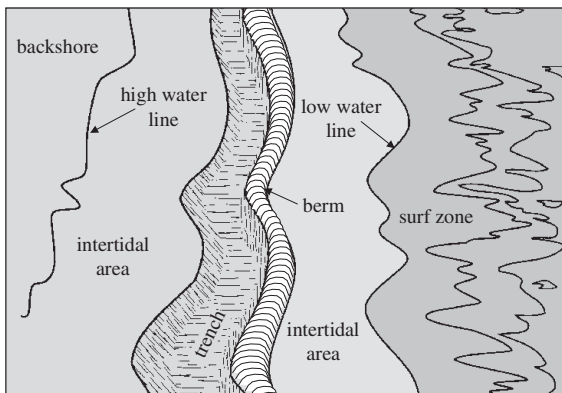

Figure 6-5 Beach Berm

Description	A dike or berm is constructed along the upper intertidal zone to prevent incoming tides from depositing oil onto back-shore areas.
Primary Uses	<ul style="list-style-type: none"> • Sandy or gravel beaches • Protects the upper intertidal and back-shore areas from contamination
Environmental Effects	Disturbs upper 2 ft (0.6 m) of beach sediments
Logistics	Beach can sustain motor traffic well <ul style="list-style-type: none"> • 1 motor grader Beach cannot sustain motor traffic well <ul style="list-style-type: none"> • 1–2 front-end loaders or bulldozers

6.5.6 Berms, Dams, and Inverted Weir on Streams

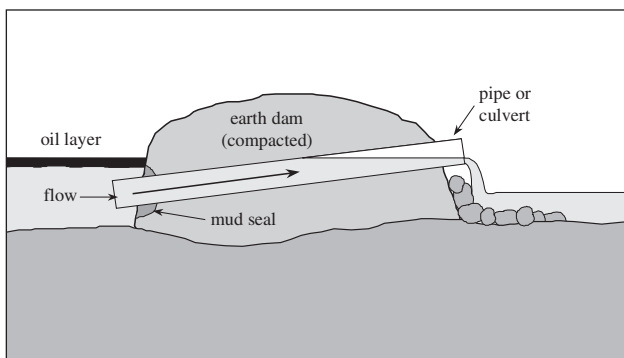

Figure 6-6 Inverted Weir

Description	Dams are constructed to either block flow completely or to block flow with a provision for underflow. Berms are constructed to control flow by diversion or underflow.
Primary Uses	Shallow streams or rivers where: <ul style="list-style-type: none"> • Booms are not available or cannot be deployed • Dams are part of the hydrological control system
Environmental Effects	<ul style="list-style-type: none"> • Local effects due to front-end loader • Blockage of fish movement
Logistics	<p>For diversion berm or underflow dam:</p> <ul style="list-style-type: none"> • Front-end loader or bulldozer • 3–6 short sections or 1 long section of boom • 1 skimmer, pump and tank <p>For inverted weir:</p> <ul style="list-style-type: none"> • Front-end loader or bulldozer • Discharge tube with or without valve • 1 skimmer, pump and tank

Traditionally, building an underflow dam or inverted weir would require larger mechanical equipment such as a front-end loader or bulldozer. An alternative would be to use a portable underflow device which replaces the dirt that would normally be required for narrow/small waterways to hold back the water and oil. Each device has numerous valves that can be opened and closed to regulate the amount of water passing underneath the dam. This device can be carried by two people which allows for greater flexibility in its use especially in areas that do not have sufficient access for large equipment.

6.5.7 Passive Sorbents

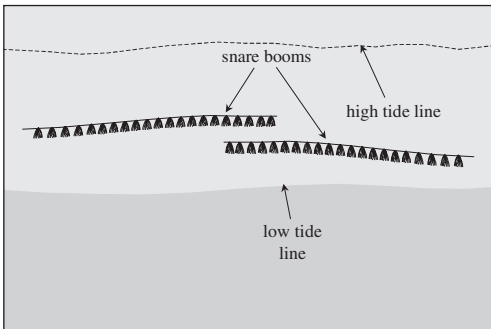

Figure 6-7 Passive Sorbents

Description	Snare booms (pom-poms on a rope) are positioned in the intertidal zone using stakes. See Section 10 for information on sorbents.
Primary Uses	Sand and gravel beaches and tidal flats
Environmental Effects	Minor disturbance to substrate
Logistics	For snare booms: <ul style="list-style-type: none"> • 2–5 snare booms • Wooden stakes • Disposal drums or large plastic bags

6.6 Material Take Off (MTO) List

There are a number of types of equipment required to successfully conduct shoreline protection.

Table 6-5 Material Take Off List for Shoreline Protection

Equipment	Use
Boom	Containing and deflecting oil
Portable Dam	Portable device to create underflow weir
Anchors	Anchoring boom
Rope	Towing, anchoring
Chain	Anchoring
Lights	Night-time illumination of boom
Sorbents	Beach protection, protection in ponds, streams
Vessels	Boom deployment, boom tendering
Motor grader	Constructing beach berms
Bulldozer and front end loader	Inverted weir construction
Skimmers	Oil collection
Containers, drums	Disposal of used sorbents, oiled debris
Pumps	Pumping oil

7 Dispersants

7.1 Introduction

Many international agencies and regulatory bodies around the world view dispersants as the most practical spill response option for offshore. In many cases, dispersing oil into the marine environment can result in the lowest environmental impact for offshore spill response. To assist in decision-making process on whether to use dispersants, a net environmental benefit analysis (NEBA) is performed. An advantage of dispersants is that they enhance the natural biodegradation process to speed removal of oil from the water, thereby reducing the potential of oil impacting shorelines, sensitive habitats, and wildlife found on or near the sea surface. This is the case for both surface application and sub-sea injection of dispersants.

Key aspects of dispersant use are listed below.

- The decision on whether or not to use dispersants should be made after considering the potential effects of dispersed oil versus undispersed slicks. This is because for large offshore spills, mechanical recovery may only encounter a small fraction of the oil leaving the majority of it untreated. The objective should be to minimize overall ecological impacts thereby maximizing net environmental benefit, i.e., through the use of NEBA.
- Use of dispersants requires logistics planning including aircraft and/or vessels, application gear, re-supply of dispersants, refueling, sufficient personnel, protective equipment, and equipment calibration.
- Many governments strictly regulate the use of dispersants. For example, in the United States, dispersants must be listed on the Environmental Protection Agency's (EPA) National Contingency Plan Product Schedule (the NCP list). In other countries, government authorities may approve dispersant use during a spill contingency plan approval process or when a spill occurs.
- For maximum effectiveness, dispersants should be applied as close to the source and as soon as possible after a spill. During the early stages of a spill, oil is un-weathered and less spread out, making it easier to target and disperse.
- Dispersants should be considered for use with other potential spill response methods and equipment, and not as a last resort.

The main goal of dispersant use is not to simply transfer oil into the water column but also to enhance its removal from the environment through the process of biodegradation. Along with this, the potential advantages of dispersants are as follows:

- Dispersants can be used over a wider range of environmental, meteorological, and oceanographic conditions than other response options for offshore spills. They can be applied in rough seas (up to 10 ft) and on thin oil slicks ($\ll 1$ mm).

- Dispersants can treat much more oil over time than other response options for offshore spills. They can be applied to surface slicks at high speeds by aircraft. In addition, aircraft allow rapid transit to a spill location and relocation to slicks separated by significant distances.
- Subsea injection of dispersants can proceed 24 hours per day and is less susceptible to any storm conditions at the sea surface.
- Dispersants can reverse, stop, or eliminate water-in-oil emulsion formation particularly when applied to low-viscosity oils. If emulsions form, the potential for oils to reach shorelines increases.
- Rapid dilution and biodegradation of dispersed oil occurs during both surface and subsea dispersant application. Dispersants accelerate the biodegradation of oil via the formation of very small dispersed oil droplets, which increase the surface area available to bacteria. Rapid dilution of dispersed oil ensures biological activity does not exhaust available nitrogen, phosphorous, and oxygen needed for biodegradation.
- Subsea injection of dispersant reduces the amount of oil rising to the sea surface and this in turn (a) reduces exposure of surface vessels and personnel to volatile components of the oil and (b) reduces the need for surface recovery using mechanical equipment, in situ burning, and surface dispersant operations. This reduces exposure of response personnel to accidents during these operations.

The potential disadvantages of dispersants are as follows:

- Dispersed oil, transferred into the water column, could potentially expose marine organisms which might not otherwise be exposed to oil. However, because dispersed oil rapidly dilutes, periods of exposure are short, and concentrations fall below toxicity thresholds within minutes to hours of initial dispersion.
- Dispersants are not effective on all types of oil. Higher viscosity oils, oils that have become more viscous, oils that have cooled below their pour point, and oils that have emulsified may be less dispersible. Some dispersants have been formulated to work on heavy and weathered oils.
- Although modern dispersant formulations exhibit low toxicity and are used in volumes that are a fraction of the spilled oil volume, they add chemicals to the marine environment. However, once in the environment, dispersants undergo the same dilution and biodegradation as the dispersed oil.
- Operationally, dispersant use on patchy slicks may be inefficient when applied by large fixed wing aircraft. A large, multi-engine aircraft such as a C-130 may have a swath width significantly greater than the width of slicks that form into windrows over time. In these cases, the advantages of aerial application may be lost as vessel-based application could be more suitable.

Potential advantages and disadvantages of dispersants are summarized in Table 7-1.

Table 7-1 Potential Advantages and Disadvantages of Dispersant Use

Advantages	Disadvantages
<ul style="list-style-type: none"> • Removing oil from the water surface keeps it from reaching shoreline 	<ul style="list-style-type: none"> • May adversely affect some marine organisms that would not otherwise be exposed to oil
<ul style="list-style-type: none"> • Is often the quickest response method 	<ul style="list-style-type: none"> • Not effective on all types of oil under all conditions
<ul style="list-style-type: none"> • Can be used in strong currents and higher sea states 	<ul style="list-style-type: none"> • If dispersion is not achieved, may decrease the effectiveness of other method
<ul style="list-style-type: none"> • Reduces possibility of sea bird and marine mammal exposure 	<ul style="list-style-type: none"> • Adds substances into the marine environment
<ul style="list-style-type: none"> • Inhibits formation of emulsions 	<ul style="list-style-type: none"> • Limited time window for use
<ul style="list-style-type: none"> • Facilitate natural biodegradation 	
<ul style="list-style-type: none"> • Dispersants lower the adhesive properties of oil 	
<p>Reference: <i>IMO/UNEP Guidelines on Oil Spill Dispersant Application</i>, 1995 edition, IMO, London, 1995.</p>	

7

7.2 Suggested Dispersants

While the COREXIT™ products have been studied extensively and are present in a number of inventories around the world, other products are available as well. For example, Oil Spill Response Ltd (OSRL) is implementing a global stockpile of 5000 m³ of three of the most common dispersants. These will be stored at various locations to enable prompt access to dispersant in the event of a release with a focus on a subsea intervention. In addition to COREXIT™ EC9500, Finasol OSR 52™ and Dasic Slickgone NS™ will also be available. Information concerning applicability, toxicity, and effectiveness should be obtained from the manufacturer.

7.3 Dispersant Use Near Sensitive Habitats

Dispersants can reduce the amount of oil reaching near shore and shoreline sensitive habitats such as:

- Mangroves
- Salt marshes
- Coral reefs
- Kelp beds

It is best to disperse oil some distance before it approaches important ecological habitats. For situations where this is not possible and with the agreement of the relevant government agencies, guidelines for using dispersants near specific ecological habitats are discussed below. In general, care should be taken to avoid excessive application.

7.3.1 *Kelp Beds*

Dispersant use is recommended for protecting kelp beds, which occur most often on rocky subtidal habitats. Dispersants should be used where there is sufficient water circulation and flushing for dilution.

7.3.2 *Seagrass Beds*

Dispersant application can protect seagrass beds in the intertidal zone. The use of dispersants over shallow, submerged seagrass beds or in areas of restricted flushing is generally not recommended, but should be weighed against the consequences of untreated oil stranding on shore.

7.3.3 *Coral Reefs and Lagoons*

Dispersant use should be considered in waters near coral reefs and lagoons to prevent oil from contacting the reefs. Applying dispersants to oil directly over shallow, submerged reefs is generally not recommended, particularly if the water exchange rate is low such as in lagoons and atolls.

7.3.4 *Nearshore Sub-Tidal Zones*

For nearshore zones of sandy and gravel/cobble beaches and for bay habitats, dispersant application is a possible option when there is sufficient water circulation and flushing capacity for dilution.

7.3.5 Tidal Flats

Dispersants should not be applied to oil that is stranded on exposed tidal flats. However, dispersant use can be considered in nearshore shallow waters after considering net environmental benefits. Limited biological impact to tidal flat sediments is expected because little dispersed oil is incorporated into the sediments.

7.3.6 Salt Marshes

Salt marshes can be protected either by applying dispersants offshore or to open water and channel areas in a marsh, but not to the marsh surface itself. If an oil slick is approaching a marsh, dispersants should be applied as the tide starts to rise, if possible. This approach will maximize dispersion of oil. Dispersants should not be used in marshes that cannot be flushed.

7.3.7 Mangroves

7

Dispersant use is a preferred technique for protecting mangroves because of the potential persistence and long term effects of oil on roots. If dispersed oil reaches a mangrove forest with a small tidal range, attempts should be made to flush it out as soon as practical.

7.3.8 Other Considerations—Marine Birds and Mammals

Dispersant use is recommended in offshore and coastal areas when this would prevent oiling of marine birds and mammals from contact with oil slicks. This is particularly true when large colonies of animals are engaged in nesting, rearing, feeding, and over-wintering activities near a shore. Direct spraying of dispersants on animals is to be avoided.

7.4 Dispersant Dosage

The conventional planning basis for dispersant dosage is 1 part to 20 parts of oil, also known as a dispersant to oil ratio (DOR) of 1:20. However, this does not take into account the wide range of properties found in both oil and dispersants which influence dispersant effectiveness. From a strategic point of view, less potent, lower cost dispersants may also be effective on oils that are easily dispersible at DORs of 1:20–30. Alternatively, lower dose rates of more potent dispersants could achieve the same goal, e.g., about 1:50–100 DORs. For oils of typical dispersibility, more robust products, such as Corexit™ EC9500 or comparable, would be used in the range of 1 part dispersant to 20–50 parts oil. For heavy oils or highly weathered

or emulsified oils, products specially formulated for heavy oils, such as Corexit™ EC9500 or similar products, may be required at levels as low as a 1:10 DOR to achieve effective dispersion. On lighter oils, dispersion may occur spontaneously or within a very short time after application. For the heavier oils, dispersion may not occur immediately and may in fact take as long as 30 minutes or more depending on wave activity, so longer term monitoring may be needed for the heavier oils to confirm effectiveness.

For typical slicks, an application rate for dispersant concentrates of between 2 and 10 US gallons per acre (19 to 94 liters per hectare) can be used. An application rate of 5 US gallons/acre (47 liters/hectare) is often used. On a volume-of-dispersant to volume-of-oil basis (i.e., the DOR), these application rates range from less than 1:100 to more than 1:10, depending on the thickness of the oil slick and its dispersibility. Two guidelines should then be followed:

- High application rates; e.g., 10 US gallons/acre (94 liters/hectare) and/or multiple pass applications are used for thicker layers of viscous oils.
- Lower rates are more applicable to thinner layers of lighter oils and to subsea injection.

The following formulas can help estimate the quantity of dispersant to apply:

$$D \text{ (dispersant dosage in US gal/acre)} = 27,200 \times t \times R$$

$$P \text{ (pump rate in US gal/min)} = 63.2 \times N \times S \times t \times R$$

where: t = average thickness of oil in inches
 R = desired dispersant-to-oil volume ratio
 N = speed of boat or aircraft in knots
 S = swath width on the water surface in feet

$$1 \text{ US gal/acre} = 9.353 \text{ liter/hectare}$$

$$1 \text{ US gal/min} = 0.0631 \text{ liters/sec}$$

For example, at a:

$$\text{speed} = N = 140 \text{ knots (1 knot} = 1.85 \text{ km/hr)}$$

$$\text{swath width} = S = 150 \text{ ft (1 ft} = 0.3048 \text{ m)}$$

$$\text{average oil thickness} = t = 0.01 \text{ in. (1 in} = 25.4 \text{ mm)}$$

$$\text{dispersant-to-oil ratio} = R = 1:40$$

$$D \text{ (dispersant dosage)} = 27,200 \times 0.01 \times 1/40 = 6.8 \text{ gal/acre}$$

or approximately 64 liters/hectare

$$P \text{ (pump application rate)} = 63.2 \times 140 \times 150 \times 0.01 \times 1/40 = 332 \text{ gal/min}$$

or approximately 20.9 liters/sec

Swath width can be estimated or measured during tests. For vessel applications, to estimate a swath width for a spray boom system, multiply the width from the hull to the outermost spray impact on the water by two (2). Fire monitor swath width depends on the type of fire monitor and can be tested over land. For aircraft, the swath width estimate is 1.2 to 1.5 times the distance between terminal nozzles for operating at a 50 ft (15 m) to 75 ft (22.5 m) altitude. Altitude and winds affect swath width, and spotter aircraft guiding spraying operations should check these parameters.

7.5 Dispersant Application Techniques

Historically, there have been two basic methods used to apply dispersants:

- Vessel application
- Aerial application

7

In 2010, dispersants were injected at the source during an offshore well control event. Subsea use of dispersants provide an effective means of introducing dispersant very close to the source of a release, thereby offering the possibility of achieving very high encounter rates. This method was credited with keeping volatile fresh oil from the surface near where responders were attempting to control and contain a well blowout. This method reduced impacts to surface dwelling marine life and shorelines and minimized exposure of workers to volatile organic compounds. If a well control incident occurs in the future, subsea dispersant injection at the source should be considered.

The main goal of dispersant use is not to simply transfer oil into the water column but to enhance its removal from the environment through the process of biodegradation. Dispersant treatment of surface slicks should proceed as illustrated in Figure 7-1, taking into account the following considerations:

- Treating a spill with dispersants should prevent the intact slick from reaching a shoreline or sensitive area.
- Normally, treatment should begin at the outer edges of the thicker parts of the slick rather than through the middle or on very thin sheen surrounding a slick.
- If the slick is near shore, the preferred spray pattern is in swaths back and forth parallel to the shoreline.

While not shown in Figure 7-1, wind conditions generally dictate the spray pattern. The following rules of thumb should be considered:

- Boats may need to travel with the wind to avoid spray blowback onto the deck.
- Aircraft should spray while flying into the wind, though downwind application may be suitable for some wind conditions.
- Aircraft should avoid spraying into strong crosswinds which can carry dispersant off target.

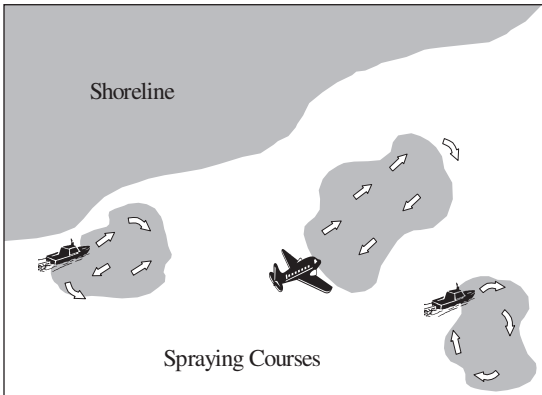

Figure 7-1 Dispersant Application

Dispersion of oil droplets into a water column is influenced by the amount of mixing energy. Dispersant application should proceed even if initial wind and sea conditions appear calm or if immediate dispersion of oil is not readily observed. Weather changes can generally be expected in marine environments (often very rapidly) and many dispersants tend to remain in an oil slick for some time after application. Further, low-energy seas make application of dispersant more efficient because slicks are easier to identify and treat.

The time taken to respond to a spill influences the effectiveness of a dispersant treatment. Over time, an oil slick weathers and becomes more viscous, especially if it incorporates droplets of water (emulsifies) and becomes a "mousse." The resulting increase in viscosity and water content makes chemical dispersion more difficult. The rate of weathering is primarily a function of oil type, slick thickness, sea state, and temperature. Treatment time can be significantly reduced by using large, multi-engine airplanes when operating over large distances.

7.5.1 Vessel Application Systems

7

Two systems for dispersant application from boats are spraying through a set of nozzles fixed on outboard arms or spraying from fire monitors. Generally, workboat systems are slow, have limited swath widths, and are used primarily for smaller spills close to land. In most cases, an airborne observer is useful to accurately guide the boat to thicker slicks. Treatment efficiency can be greatly enhanced if the vessels are re-supplied with dispersant and re-fueled at the treatment location to lessen delay in spray operations.

7.5.1.1 Vessels with Spray Arm Systems

- Spray arms with nozzles can be used to give a flat, uniform spray of droplets, not a fog or mist.
- Spray arms should be mounted as far forward as possible to minimize bow wave impacts.
- The added mechanical energy of a wake from a boat can enhance dispersion. Other dispersion-enhancing techniques that have been used and might be useful for some applications (e.g., nearshore and/or calm conditions) include the use of firehose water streams, other wakes produced by small boats, and towed wooden panels ("breaker boards").

Dispersant spray systems for boats are available from various manufacturers. Many differ in design, capability, versatility, size, weight, ease of handling, and control of dosage. Some equipment is fabricated for specially designed vessels.

Spray arm systems for boats should:

- Be easily transported and loaded.
- Preferably be light in weight, yet rugged.
- Be quickly and easily installed.
- Preferably have a pump as an integral part of the system and have a pressure gauge at the main pump outlet.
- Be versatile, i.e., easily adapted for different nozzles, for a range of dosages and use situations, or for placement on other vessels.
- Be equipped with nozzles that will produce a flat spray of droplets (not mist or fog) striking the water in a line perpendicular to the direction of travel of the vessel.
- Have features that allow variation/regulation/measurement of dispersant flow and water flow (if dilution is used).
- Be calibrated (using water) under potential conditions (e.g., variations in boat speed, water/dispersant flow rates, swath width sprayed) and have calibration charts prepared for use during spill response.

7.5.1.2 Vessels with Fire Monitors or Other Single Point Spray Systems

Fire monitors or similar hose-like devices on vessels are effective dispersant application systems provided that proper nozzles, pressures, flow rates, dispersant metering, and vessel operation practices are employed.

Two fire monitor application systems are recommended. The most flexible and easiest to operate is a package that uses positive pressure injection of dispersant into the water flow. This system relies on external pressure and metering systems to deliver a specific quantity of dispersant to the pressurized water stream. The second system uses eductors to draw dispersant into the water flow. The main advantage of an eductor system is its simplicity. The main disadvantages are poor control available on the amount of dispersant being drawn into the water stream and inflexibility in dealing with wide ranges of flows and pressures. Both systems rely on water-diluted application of the dispersant with a typical concentration of dispersant in the water stream of 5 to 10%.

Fire monitor dispersant application systems are capable of treating up to four times as much area as spray arm system. This is primarily due to their greater swath width, faster vessel speed, and the pitch and roll of a vessel, which do not affect the system to the same degree as the spray arm system. Fire monitor dispersant application systems are rugged for open water applications. Furthermore, vessels equipped with a fire monitor application system can perform other operations when not responding to spills.

When a fire monitor or fire hose is used, then raising the outlet nozzle to about 32° above horizontal will generally give the greatest reach. Mounting a “break-up screen” (coarse 4-mesh) over the end of the nozzle will spread the spray over a greater area. At the water surface, droplets should resemble a fine rain, not a fog or mist. If the fire monitor has an adjustable nozzle, the optimum adjustment is generally just short of the “straight-stream” position.

7.5.2 Aircraft Application

There are several factors to consider when applying dispersants from aircraft:

- As with boats, an important concern is a properly designed system of tanks, pumps, and nozzles. Dispersant droplet size in the range of 0.01-0.03 in (300-700 micron) is typically optimal for effective application.
- Some large helicopters and airplanes can treat more area per day than boats, especially when slicks are offshore or in remote areas.
- Helicopters and small fixed-wing aircraft are more appropriate for small spills or fragmented slicks close to shore.
- Large, multi-engine airplanes such as L-100/C-130 Hercules, DC-6, or DC-4 or DC-3 aircraft are appropriate for large spills, particularly in relatively open waters or far from shore.
- Jet aircraft, e.g., Boeing 727s and 737s, are being considered and developed as dispersant platforms (Figure 7-2). They offer much quicker transit to and from an oil spill, potentially increasing the surface slick size that may be treated effectively.

The characteristics of typical aircraft suitable for aerial dispersant spraying are given in Table 7-2. The dispersant delivery capabilities in a 10-hour day of various types of aircraft are shown in Table 7-3.

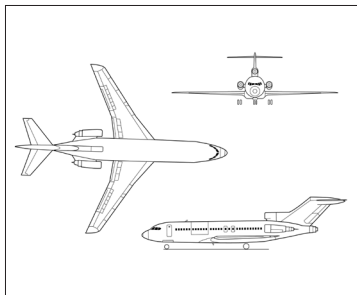

Figure 7-2 An example of the jet aircraft developed as a dispersant application platform

Table 7-2 Characteristics of Aircraft Suitable for Aerial Dispersant Spraying

Aircraft Type	Dispersant Tank Capacity		Transit Speed	Minimum Runway Length	
	gal	liters	knots	ft	m
Purpose-built Single-engine Agricultural Aircraft					
Aerospace Fletcher Cresco	405	1530	140	985	300
Aerospace Fletcher	275	1045	115	805	245
Air Tractor 502	500	1890	180	900	275
Air Tractor 602	630	2390	180	900	275
Air Tractor 802	800	3030	180	900	275
Antanov An 2 R	370	1400	100	490	150
Basant	240	900	100	705	215
Cessna Agtruck	280	1060	100	1310	400
Desmond Norman Fieldmaster	695	2640	145	575	175
EBM 701 Ipanema	180	680	105	1525	465
IAR-822	160	600	80	985	300
Pilatus Porter PC-6	250	950	110	590	180
Piper Brave 300	225	850	125	970	295
Piper Pawnee D	150	570	90	805	245
PZL Dromader M18	660	2500	100	820	250
PZL 106A Kruk	370	1400	90	720	220
Super AgCat B	300	1135	100	590	180
Thrush Commander	360	1365	100	985	300
Turbo Thrush	600	2275	125	820	250
Transavia Air Truk	215	820	95	1100	335
Converted Single and Multi-engine Aircraft					
<u>Helicopters (fuselage mounted)</u>					
Aerospatiale Lama	300	1140	80	—	—
Aerospatiale AS 350	290	1100	120	—	—
Bell 47	105	400	75	—	—
Bell 206	180	680	115	—	—
Bell 212	400	1515	125	—	—
Hiller UH-12E	132	500	80	—	—
Hughes 500	180	680	115	—	—
Enstrom F-28C	105	400	70	—	—

Table 7-2 Characteristics of Aircraft Suitable for Aerial Dispersant Spraying (continued)

Aircraft Type	Dispersant Tank Capacity		Transit Speed	Minimum Runway Length	
	gal	liters	knots	ft	m
Fixed-Wing					
Beech Varon	120	450	200	1345	410
BN Islander	125	480	140	560	170
BN Trislander	330	1250	145	1295	395
Canadair CL 215	1400	5300	160	3000	915
DC-3	1215	4600	130	3280	1000
DC-4	2500	9460	190	5000	1525
DC-6	3500	13250	210	5000	1525
Fokker F-27	1000	3780	260	3250	990
Grumman Avenger	530	2000	200	3000	915
737 Jet Aircraft	4000	15142	485	6000	1829
Lockheed L-100/C-130	5500	20820	300	5170	1575
Piper Aztec	150	570	175	985	300
Shorts Sky Van	315	1200	170	1675	510
Twin Otter	555	2100	170	1050	320
Volpar Turbo Beech 18	290	1100	220	1675	510
727 Jet Aircraft	4623	17500	480	6000	1829
737 Jet Aircraft	4200	15899	460	5000	1524
Conversions: 1 liter = 0.264 gallons (US) 1 knot = 1.85 km per hour 1 foot = 0.3048 meters					

7

*Table 7-3 Aircraft Capability for Oil Dispersant Delivery
Over 10-Hour Period*

Aircraft	Dispersant Load (gal)	Distance to Spill Site (miles)	Time per Flight (minutes)	Flights per 10-Hour Period	Number of Refueling Stops	On-site Working Time per 10 Hours (minutes)	Volume of Dispersant Delivered in 10 Hours (gal)
Helicopter	100	30	69	9	4	104	900
	300	30	94	6	5	219	1,800
	600	30	101	6	5	264	3,600
	100	50	103	6	5	69	600
	300	50	128	5	4	183	1,500
	600	50	135	4	3	176	2,400
Piper Pawnee	100	30	53	11	5	127	1,100
	150	30	59	10	4	178	1,500
	100	50	77	8	3	92	800
	150	50	83	7	6	124	1,050
DC-3	1,200	30	54	11	2	330	13,200
	1,200	50	70	8	2	240	9,600
	1,200	120	126	4	2	120	4,800
	1,200	170	166	3	2	90	3,600
DC-4 (C54)	2,100	30	60	10	2	303	21,000
	2,100	50	74	8	2	242	16,800
	2,100	120	120	5	1	151	10,500
	2,100	170	154	4	1	121	8,400
DC-6	3,000	30	55	11	2	319	33,000
	3,000	50	65	9	2	261	27,000
	3,000	120	103	6	2	174	18,000
	3,000	170	131	5	2	145	15,000
C-130	5,000	30	53	11	2	297	55,000
	5,000	50	63	9	2	243	45,000
	5,000	120	101	6	2	162	30,000
	5,000	170	129	5	2	135	25,000
Conversions: 1 gal = 3.785 liter 1 mile = 1.6 km							

7

The number of nozzles used depends on the flow rates employed. The differential velocity between the aircraft speed and the exit velocity of a dispersant fluid should be less than about 210 ft/sec (64 m/sec) for best depositional efficiency.

$$V_d = V_a - V_f$$

$$V_f \text{ (ft/sec)} = \frac{0.41 \times \text{total gpm} / \text{number of nozzles}}{d^2}$$

where:

- V_d = differential velocity, ft/sec
- V_a = aircraft ground speed, ft/sec
- V_f = fluid exit velocity, ft/sec
- d = nozzle diameter, in

Smaller planes and helicopters, such as those used for agricultural spraying and forest fire fighting, have been and can be adapted for dispersant spraying. Although this would not serve for all operating speeds or pump rates, as a general guide, these small aircraft should not use nozzles with external orifice diameters smaller than 0.156 in (4 mm). Preferably, they should have no more than a total of 30 to 35 operating nozzles per plane.

The mechanical shear rate of a nozzle should be as low as possible and preferably less than 10,000 sec⁻¹ to avoid generation of small droplets that may result in misting. The formula noted below can be used to calculate mechanical shear.

$$\text{Shear Rate (sec}^{-1}\text{)} = 3.9 \text{ } q/d^3$$

where:

- q = flow rate (gal/min) *note: if flow is given in ml/sec, use $q = \frac{\text{ml/sec}}{63.08}$*
- d = orifice diameter (in)

Dispersant viscosity can affect flow rate and spray patterns and should be checked at the application temperature. For satisfactory aerial spraying of dispersants, dispersant viscosity at application conditions should be taken into account, as shown in Table 7-4.

Table 7-4 Dispersant Fluid Viscosity and Application Conditions

Dispersant Fluid Viscosity (at application temperature)	Application Condition
≥ 60 centiStokes (cSt)	<ul style="list-style-type: none"> • Best for aerial application
30–60 cSt	<ul style="list-style-type: none"> • Adequate if aircraft's ground speed is less than 100 mph (160 km/hr) and altitude is not over 30 ft (10 m)
< 30 cSt	<ul style="list-style-type: none"> • Not satisfactory for aerial application since a fluid stream is easily shattered by air shear • Produces extremely small size droplets, which are subject to excessive drift

7.6 Material Take Off (MTO) List

7

There are a number of types of equipment required to successfully apply dispersants.

Table 7-5 Material Take Off List for Dispersants

Equipment	Use
Dispersant	Oil dispersion
Tanks	Temporary storage of dispersants
Pumps	Transfer of water/dispersant
Boats/Vessels	Dispersant application platform
Fixed-wing aircraft	Dispersant application platform, directing and monitoring operations (spotter aircraft)
Helicopters	Dispersant application platform
Fuel	Fueling aircraft
Spray equipment	Dispersant application
Tools	Setting up spraying, adjusting and repairing connections
Radios	Communication among vessels/aircraft
GPS	Positioning aircraft and vessels, documenting operations

8 In-Situ Burning

8.1 Introduction

In-situ burning (burning oil in place) can quickly eliminate large quantities of spilled oil. In-situ burning removes oil from a surface by combustion of hydrocarbon vapors and their conversion into predominantly CO₂ and water which are released to the atmosphere. There are often situations where burning may provide the only means of quickly and safely eliminating large amounts of oil. The objective is to select the optimal equipment and application techniques that will result in the least overall environmental impact.

Burning small spills has been routinely conducted for the following purposes:

- To quickly remove oil, so that it does not spread over larger areas or to sensitive sites.
- To reduce the generation of oily wastes, especially where transportation or disposal options are limited.
- As a final removal technique, when other methods begin to lose effectiveness or are judged to be too intrusive.

8.1.1 Regulatory Approval

8

In the United States, many coastal areas have been pre-approved for in-situ burning under certain conditions. This pre-approval process is an important step, and it will expedite the formal process of obtaining final approval to burn in the event of an oil spill. In contrast, many nations have yet to provide in-situ burning guidance or regulations.

Burning is valued where there are hard surfaces (manmade, snow, ice), ditches or trenches to collect spilled oil from porous soils, shallow water, soft substrates, or the remoteness of the location limits access to the spill site. The following conditions favorable for burning have been identified:

- Spills of fresh crude oil or light, refined products either on land, in freshwater, lakes, ponds, and streams, in marshes, or in offshore marine environments
- Winds <~20 miles/hour offshore and <12 miles/hour onshore (34 km/hr and 19 km/hr, respectively) for ignition
- Remote or sparsely populated sites
- Mostly herbaceous vegetation (fields, crop land, marshes)
- Dormant vegetation (not in active growing season)
- Unvegetated or poorly vegetated areas (dirt roads, ditches, dry streambeds)

- In wetlands with a water layer covering soil substrate, or water-saturated soils
- Where snow and ice provide natural containment and substrate protection
- In offshore environments

Advantages and disadvantages of In-Situ Burning are summarized in Table 8-1.

Table 8-1 Advantages and Disadvantages of In-Situ Burning

Advantages	Disadvantages
<ul style="list-style-type: none"> • Can quickly remove large amounts of oil 	<ul style="list-style-type: none"> • Ignition of weathered or emulsified oil can be difficult
<ul style="list-style-type: none"> • Can lessen recovery time and disposal chain for oily wastes 	<ul style="list-style-type: none"> • Generates smoke and soot
<ul style="list-style-type: none"> • Once ignited, most oils will burn 	<ul style="list-style-type: none"> • Has inherent but manageable safety risks
<ul style="list-style-type: none"> • Can be used in any water environment (marine, estuarine, freshwater) 	<ul style="list-style-type: none"> • Some residues can sink
<ul style="list-style-type: none"> • Can be carried out at night 	<ul style="list-style-type: none"> • Fire booms required for burning of freshwater and marine oil spills are large pieces of equipment that are a challenge to rapidly transport

8.2 Basics of In-Situ Burning

8.2.1 Basic Requirements of In-situ Burning

- Oil layer thickness must be approximately 2 to 3 mm (0.08–0.12 in) or more to generate burnable concentrations of hydrocarbon vapors to sustain combustion.
- Oil must be relatively fresh and not contain too much water (i.e., emulsified) to generate burnable concentrations of hydrocarbon vapors to sustain combustion.
- Quantity of spilled oil should be sufficient to generate a supply of hydrocarbon vapors to sustain a burn, once it is ignited.

- A fire-resistant boom is generally used on open water to hold the oil in thicker slicks to help sustain a burn.
- An igniter is used to heat spilled oil to release more hydrocarbon vapors and then to ignite them to start a burn.
- For oils which are difficult to burn, an accelerant or promoter (e.g., lighter, highly evaporative oil) can be applied to assist with ignition.

For burns on water, the boom holding capacity can be estimated from Figure 8-1. Mouth openings of 0.3 total boom length ($0.3 \times L$) and 0.6 total boom length ($0.6 \times L$) are shown. The $0.3 \times L$ configuration is recommended since it requires lower boom tension and is more easily controlled.

8.2.2 Efficiency of In-situ Burning

Burn efficiency depends on the original oil thickness, its weathering state or burnability, and, in a continuously fed oil fire, how well burn areas are maintained throughout the burn process.

- Thick oil layers (13 mm or more) normally burn with a thickness reduction rate of 2.54 mm /minute (i.e., about 2.5 liters per minute per square meter of burn area or 0.7 gallons / minute per 10 ft²).
- With combustion normally taking place until the final thickness is approximately 1 mm, burn efficiencies in excess of 90% can be achieved. Figure 8-2 can be used to determine the area required to consume various amounts of encountered oil.

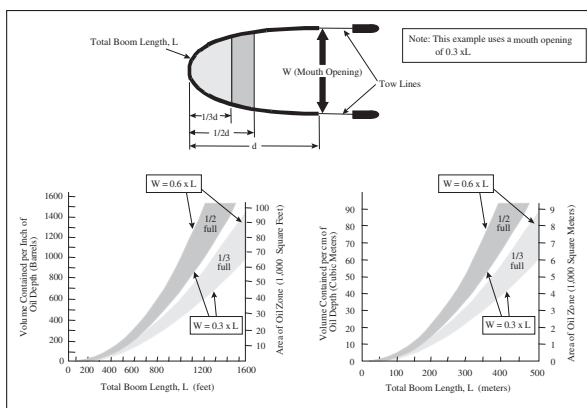

Figure 8-1 Estimating Boom Holding Capacity

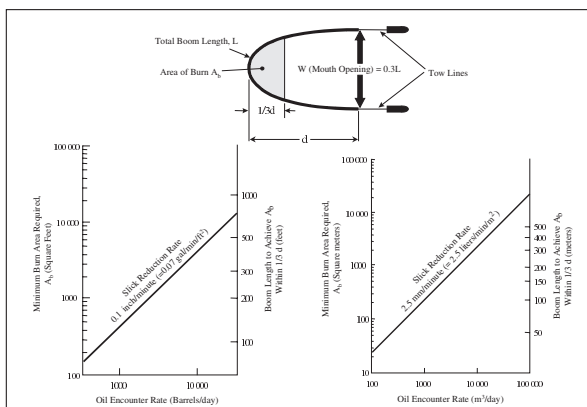

Figure 8-2 Estimating Area Required for Various Oil Encounter Rates

8.2.3 On-Water Conditions and Weathering

Oil slicks thicker than 2 to 3 mm (0.08–0.12 inches) on water can be ignited easily under light wind and wave conditions. Ignition and burning of floating oil may still be possible in winds up to approximately 21 mph (18 kts or 34 km/hr) and/or in waves as high as 1–1.5 m (3–5 ft). Ignition and sustained combustion may occur under much more severe conditions if the spilled oil is fresh and unemulsified.

Ignition of floating oil is affected by evaporative losses, dispersion (chemical or natural), and water-in-oil emulsions. Water content of 15 to 25% makes ignition difficult for some oils. For most oils, a 50 to 70% water content makes ignition almost impossible unless very large ignition areas, igniters, and/or other fire promoters are used. Minimum ignitable thicknesses include:

- Fresh oil: 1 mm
- Aged un-emulsified crude and diesel: 2–5 mm
- IFO 380, Resid, Bunker C: 10 mm

8.2.4 Recovery of Residue

Most crude oils will leave an unburnable residue after burning. This residue primarily consists of the non-volatile components in the oil: mostly inert tars and asphaltenes. Unburned oil residue may reach a thickness of several centimeters and be sufficiently viscous to be picked up with equipment such as boat hooks, screened rakes, or pitch

forks. Fishing nets with relatively small openings (2.5 cm [1 in] or smaller) would be adequate to corral and recover the buoyant residue from on-water burns. The residue, and most likely the fishing nets, could then be placed in plastic-lined containers or in drums for disposal.

8.3 Burning Equipment

The main equipment required for in-situ burning on land, snow, or ice is an igniter. The main equipment required for in-situ burning on water consists of fire-resistant boom, igniters, and vessels to pull the boom. Similar to conventional boom, fire-resistant boom requires ancillary equipment such as towing lines, bridles, buoys, and anchors. For pressure-inflatable boom, an air compressor is needed. Fire-resistant boom and igniters specific to in-situ burning are discussed in this section. Chemical herders could be used to help with on water burns.

8.3.1 Fire-Resistant Boom

8 Fire-resistant boom made of rugged material, such as stainless steel, can survive repeated burning for long periods. However, it is heavy and difficult to handle. Other types of less rugged boom incorporate fire-resistant, mineral-based fabric and ceramics in their structure. This less rugged boom is lighter and easier to deploy, position, and retrieve, but it may not be as capable of long-term deployment or tolerate long-term exposure to fire. The latest design of fire boom uses fire resistant fabric over a water-cooled interior, making the boom more durable and therefore reusable. In some instances, especially where the length of a fire boom is limited, conventional boom can be used as extenders on either end of a fire boom.

8.3.2 Igniters

A good ignition system has the following features:

- It produces a reliable source of heat that causes rapid vaporization of a surrounding oil slick without forcing the oil away from the igniter.
- It is safe to operate, simple in design, easy to use, has minimal storage and transportation requirements, and has a long shelf life.

For safety reasons, aircraft pilots generally prefer to work with ignition systems that do not involve lighting fuses within aircraft and releasing an igniter by hand from an open window or door.

Two types of ignition systems are commercially available: igniters for use from land or on a vessel and igniters used from helicopters. The two types are listed in Table 8-2.

Table 8-2 Igniters

Deployment	Igniter
Surface (including vessels)	<ul style="list-style-type: none"> • Propane or butane torch • Drip torch • Flare • Gelled fuel in hand-held container • Plastic Sphere Dispenser (PSD) • Terra torch
Aerial	<ul style="list-style-type: none"> • Helicopter-slung gelled fuel, contained in a remote controlled torch • Plastic Sphere Dispenser (PSD) (for on-land spills)

8.3.3 Chemical Herders

Chemical herders can be used to aid in-situ burning without booms. They are composed of surfactants dissolved in one or more solvents. Herders sprayed onto water surrounding an oil slick cause formation of a layer of surfactants on the water surface. When the surfactant layer reaches the edge of a thin oil slick it changes the balance of interfacial forces acting on the slick edge causing contraction of the oil into a thicker layer. Herders do not require a boundary to “push against” and work even in open (boundary-free) water. Herding agents applied around the perimeter of an oil slick can keep slicks from spreading and cause thin slicks to “herd” into thicker slicks. This action can keep slicks from spreading too thin to burn and can thicken slicks that are already too thin.

Herders have been approved for listing on the United States National Contingency Plan Product Schedule. Commercial quantities of herder, and a herder delivery system capable of being mounted in the cabin of a helicopter are available.

Herders are an important advance for in-situ burning because they can be deployed from a helicopter. This same helicopter can also carry ignition devices. Figure 8-3 shows a helicopter with a heli-torch ignition system. The drawing shows herder already sprayed around the perimeter of the slick.

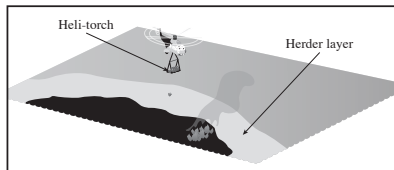

Figure 8-3 Conceptual drawing showing a helicopter herder – ISB system

8.4 Burning Operations

In-situ burning can be conducted on shorelines, inshore areas like wetlands or marshes, upland areas like fields and open terrain, on snow and ice, and in some forested areas if there is sufficient fire control. Until recently, most burn have been conducted in inland or upland areas.

8.4.1 Inland or Upland Burning

The following operational and post-burn guidelines need to be considered for inland or upland burns:

- Regulatory approvals.
- A means of fire control.
- Physical disturbance of the vegetation and substrate should be avoided.
- When oil does not ignite readily, an accelerant, e.g., diesel, may be needed.
- A crust or residue (which may hinder revegetation) may remain after incomplete combustion of spills on land, and may need to be cracked or removed.

8

The U.S. Department of Agriculture (USDA) Forest Service maintains a Fire Effects Information System. This database can be used to review information on local ecology and effects of fire on specific plant species.

- Erosion may be a problem in burned areas if plant cover is greatly reduced.
- Vegetation in, and adjacent to, a burn site can be affected by burning, including short or long term changes in the plant community.
- Burning can severely affect organic soils, such as peat, unless they are saturated.

Table 8-3 Inland and Upland Burning

Description	
Oil is removed from a shoreline, ice / snow or soil surface by burning.	
Application	
<ul style="list-style-type: none"> • Use on any substrate or vegetation, except mangroves, where oil volume and properties will sustain combustion. • Ignite the downwind end of oiled area and burn upwind. • Use also on large pools of oil and on oily debris, e.g., logs. 	
Possible Adverse Effects	
<ul style="list-style-type: none"> • Can result in mortality of surface organisms in a burn area. • Can cause erosion if root systems are damaged; also may result in localized and temporary air pollution. • Heating can reduce oil viscosity resulting in deeper oil penetration into a porous soil/beach, depending on their saturation. • Generates black smoke and should not be used near population centers. 	
Primary Equipment	Type
Ignition Source	<ul style="list-style-type: none"> • Plastic Sphere Dispenser (PSD) • Helitorch • Drip Torch • Terratorch • Flares
Fire-fighting equipment	<ul style="list-style-type: none"> • Small fire trucks • Portable fire pumps with nozzles
Consumables	Type
Ignition agents	<ul style="list-style-type: none"> • Gelled gasoline • Diesel fuel • Flammable materials (rags soaked in diesel fuel, wood chips, dried brush, etc.) • Plastic spheres filled with potassium permanganate
Personnel	Treatment Rate
2-3 workers to ignite and control fire	See Section 8.2.2 burning rates
1 foreman for every 10 workers	
Access	
Foot path, roadways, shallow craft or helicopter	

8.4.2 Burning on Water

To conduct in-situ burning operations on water using booms, two vessels are generally needed to tow fire-resistant boom (Figure 8-4). One or two other vessels are needed for logistic support, such as transfer of personnel and recovery of residues. For larger spills, a spotter airplane should be used to assist in locating oil slicks, directing boom operations, and safety surveillance. Furthermore, it is strongly recommended that firefighting vessels be on site in case of any secondary fires.

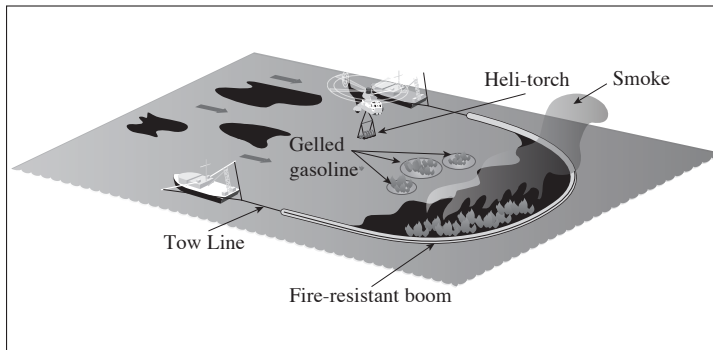

Figure 8-4 Typical In-Situ Burning Operation on Water

The transport and deployment of fire containment booms is not appreciably different from standard containment booms. Some fire booms are stored on reels, and the booms are deployed from, and retrieved back to, these reels. As long as the reels are properly sized, these booms can be transported in a variety of aircraft.

Other fire booms are stored in cradles that are lowered into the water during deployment to allow the boom to be towed out of the cradles. Fire boom is considerably heavier than most booms and is consequently more difficult to handle out of the water. The cradles do not fit in many types of aircraft, and the boom may have to be repackaged for air transport.

Any one of these booms could be damaged during burn operations, and retrieval could become difficult. Oil can penetrate deeply and soak the interior of the booms, and retrieval to the decks of vessels can be quite messy. While fire boom retrieval may be difficult, it must be compared to the difficulty of handling skimmers, transfer hoses, and storage containers during traditional oil recovery operations using mechanical devices.

Table 8-4 Burning On Water

<p>Description</p> <p>Oil is removed from the water's surface by burning.</p> <p>Application</p> <ul style="list-style-type: none"> • Use on open water where oil volume and properties will sustain combustion. • Boom oil to make it thick enough to burn. • Ignite the downwind end of oiled area and burn upwind. <p>Possible Adverse Effects</p> <ul style="list-style-type: none"> • Generates burn residue that has the potential to harm benthic organisms if not collected • Generates black smoke and should not be used near population centers. 	
Primary Equipment	Type
Ignition Source	<ul style="list-style-type: none"> • Marine flares • Helitorch
Fire Resistant Boom	
Vessels	<ul style="list-style-type: none"> • 2 for towing fire resistant boom • 1-2 small craft for ignition control
Consumables	Type
Ignition agents	<ul style="list-style-type: none"> • Gelled gasoline • Diesel fuel • Flares
Fire Resistant Boom	
Personnel	Treatment Rate
<p>2-3 workers to ignite fire</p> <p>2 crews for vessels pulling fire resistant boom</p>	See Section 8.2.2 burning rates

8.4.3 Burning and Wind

Wind direction and strength (speed) each have an influence on the conduct of burn operations, whether on land or on water. Wind conditions and forecasts should be studied prior to burn operations.

Burning is most often planned with regard to wind direction for better fire control. Igniting a burn at an up-wind location provides added, natural fire control because the spread of flames and heat must overcome the contrary direction of the wind (Figure 8-5).

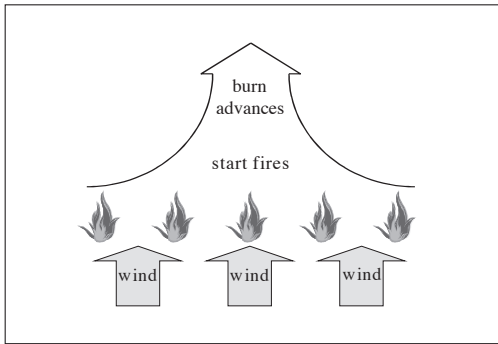

Figure 8-5 Initiating an In-Situ Burn

Wind strength can have a limiting influence on ignition. Since it is the hydrocarbon vapors evaporating from an oil slick which burn, those vapors must first collect in sufficient concentration to ignite. Winds tend to disperse vapors. A basic rule of thumb is that vapor concentrations cannot be maintained at wind speeds of > 35 knots (40 mph).

Once a burn is ignited for spills on water, there can be instances of induced winds created by the rising combustion plume from a larger burn. These winds can have a positive effect on total oil removals by drawing surrounding oil to a burn site for combustion.

8.5 Material Take Off (MTO) List

Various types of equipment are required to successfully ignite and burn oil, as listed in Table 8-5.

Table 8-5 Material Take Off List for In-Situ Burning

Equipment	Use
Fire-resistant boom	Slick containment
Rope	Towing
Cable	Towing
Conventional boom	Slick containment
Herder	Slick containment
Vessels	Ignition, boom deployment, fire-fighting
Helitorch	Ignition
Plastic Sphere Dispenser	Ignition
Hand-held igniters	Ignition
Gelled fuel/burning agents	Ignition
Vessels	Ignition, boom deployment
Fixed wing aircraft	Slick spotting, monitoring
Helicopters	Monitoring and slick ignition
Tools	Setting up igniter, booms; also for repairs
Radios	Communication among vessels/aircraft
Air monitors	Air quality sampling
Still/video cameras	Documentation
GPS	Positioning, documentation of operations

9 Skimmers

9.1 Introduction

Skimmers are mechanical devices that physically remove free or contained oil from the surface of water. There are many different types of skimmers but they can be grouped into four categories based on oil recovery principles. Each category contains various skimmer types distinguished by their oil collection mechanisms (Table 9-1) as well as other factors.

Manufacturers frequently offer several sizes or models of the same basic skimmer type and, in many cases, have updated older models with newer versions. For any given skimmer type, numerous manufacturers produce similar devices, each with its own specific design. Detailed performance and operational information are presented in Section 9.3 based on many decades of oil industry experience. However, this information is provided for background and general guidance only. The best source of data and information about a specific skimmer is the manufacturer. In a spill response, people use whatever skimmers are readily available so the information presented here is more useful for the selection and purchase of skimmers in advance of any response emergency. For responding in cold conditions, some skimmers can be fitted with a steam heating system to melt snow and ice in contact with the skimmer and to warm recovered oil for ease of pumping.

*Consider each skimmer based on its own merits
and the anticipated spill conditions.*

Table 9-1 Skimmer Types

Skimmer Category	Examples
Weir skimmers	Simple, self-leveling, integral screw auger, advancing, and boom/weir systems
Oleophilic surface skimmers	Drum, grooved drum/disc, disc, fabric-coated drum/disc, rope mop, sorbent lifting belt, and brush
Hydrodynamic skimmers	Water jet, submersion plane/belt, and rotating vane
Other devices	Paddle belt, trawl/boom, vacuum skimmers

The advantages and disadvantages of mechanical skimmers are listed in Table 9-2.

Table 9-2 Advantages and Disadvantages of Skimmers

Advantages	Disadvantages
<ul style="list-style-type: none"> Physically remove oil from the aquatic environment 	<ul style="list-style-type: none"> Relatively low encounter and recovery rates, especially in thin slicks
<ul style="list-style-type: none"> Available in practically every equipment stockpile 	<ul style="list-style-type: none"> The use in high seas and high currents is often not practical
<ul style="list-style-type: none"> Can be used in any water environment (bays, inlets, etc.) 	<ul style="list-style-type: none"> Considerable ancillary and supporting equipment must be planned for
<ul style="list-style-type: none"> Their use is widely accepted 	<ul style="list-style-type: none"> Can be clogged by debris and ice

9.2 Skimmer Selection Matrix

Skimmer performance can be rated in three ranges of oil viscosity (Figure 9-1).

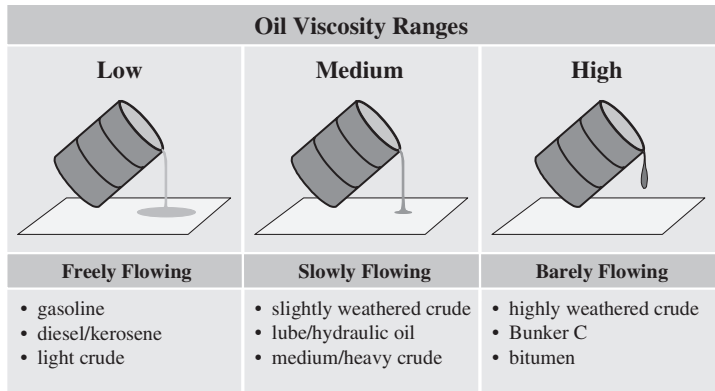

Figure 9-1 Oil Viscosity Ranges

Three sea states are considered in this section (Table 9-3).

Table 9-3 Sea States

Operating Environment	Significant Wave Height feet (m)	Wind Speed knots (m/s)
Calm water	<1 (<0.3)	< 6 (< 3)
Protected water	<3 (< 1)	<16 (< 8)
Open water	<6 (< 2)	<21 (<10)

Table 9-4 is a simple matrix that can be used to select a skimmer best suited for a particular cleanup need. The expected performance of 17 generic types of skimmers is rated according to 12 performance criteria.

Table 9-4 Skimmer Selection Matrix

		Skimmer Type																
		Weir Skimmers					Oleophilic Skimmers						Hydro-dynamic Skimmers		*			
		Simple Weir	Self-Leveling Weir	Weir with Integral Screw Auger	Advancing Weir	Weir Boom	Drum	Disc	Grooved Drum/Disc	Fabric-Coated Drum/Disc	Rope Mop	Zero Relative Velocity Rope Mop	Sorbent Lifting Belt	Brush	Water Jet	Submersion Plane/Belt	Rotating Vane	Paddle Belt
Operating Environment	Open Water	●	●	●	○	○	○	○	○	○	○	○	○	○	○	○	○	○
	Protected Water	○	●	●	○	○	○	○	○	○	○	○	○	○	○	○	○	○
	Calm Water	○	○	○	○	○	○	○	○	○	○	○	○	○	○	○	○	○
	High Current >1 knot (> 0.5 m/s)	●	●	○	○	○	●	●	●	●	○	●	○	○	○	○	○	○
	Shallow Water <1 foot (< 0.3 m)	○	○	●	●	●	○	○	○	○	○	●	●	○	●	○	○	○
	Debris (Including ice)	●	●	○	○	○	○	○	○	○	○	○	○	○	○	○	○	○
Oil Viscosity	High Viscosity	●	●	○	○	○	○	○	○	○	○	○	○	○	○	○	○	○
	Medium Viscosity	○	○	○	○	○	○	○	○	○	○	○	○	○	○	○	○	○
	Low Viscosity	○	○	○	○	○	○	○	○	○	○	○	○	○	○	○	○	○
Skimmer Characteristics	Oil/Water Pickup % **	●	○	○	○	○	○	○	○	○	○	○	○	○	○	○	○	○
	Recovery Rate	○	●	●	○	○	○	○	○	○	○	○	○	○	○	○	○	○
	Ease of Deployment	○	○	○	○	○	○	○	○	○	○	○	○	○	○	○	○	○
	Available as VOSS (Vessel of Opportunity Skimming System)	✓	✓	✓		✓	✓	✓	✓	✓		✓	✓			✓	✓	
	Available as Advancing Skimmer				✓	✓		✓			✓	✓	✓	✓	✓		✓	
	Available with Storage				✓	✓	✓	✓	✓	✓	✓	✓	✓	✓	✓	✓	✓	

Legend ○ Good ○ Fair ● Poor ✓ = Yes

* Other Devices

** Oil/Water Pickup % = % Oil in Recovered Product

The parameters rated in the Skimmer Selection Matrix (Table 9-4) should be considered together with other aspects when assessing a skimmer. The ratings of some criteria are independent of the size of a skimmer while the ratings of other criteria are directly proportional to skimmer size. For example, oleophilic discs operate poorly in debris but have high recovery efficiencies (low water pickup) regardless of disc or skimmer size. Recovery rate and suitability for use in open water, however, strongly depend on the size of a skimmer. A “good” rating, in any case, means that a commercial version of that skimmer type is available that will deliver the indicated performance. A more detailed assessment of each skimmer type is provided in Sections 9.3.1 to 9.3.17.

Users should be aware that the nominal oil recovery rate of a skimmer is seldom achieved due to difficulties associated with changing conditions, e.g., diminishing layers of oil.

The availability of three additional skimmer features is indicated in the last three rows of the Matrix:

- Deployable from an existing workboat as a Vessel of Opportunity Skimming System (VOSS)
- Can be used as an advancing skimmer (some models are designed to be towed through the water)
- Available with storage (some models have integral storage)

9

Stationary skimmers, i.e., those that are not towed or self-propelled, are generally used inside containment booms where the oil layer thickness can be maximized.

The following guidelines should facilitate skimmer operation:

- Skimmers that incorporate relatively complex mechanical systems, e.g., those with rotating or moving oil pickup mechanisms, require operator experience for effective/efficient use.
- Skimmers used with centrifugal pumps can mix oil and water to form emulsions that cannot be readily separated. This adds to the volume of liquid that must be transported.
- Skimmers with screw auger pumps can be used to recover highly viscous oils and debris.
- Weir skimmers tend to collect a substantial amount of water, especially when operated in waves.
- Weir skimmers work best in thick slicks in calm water.
- All skimmers will pick up some water, and oil/water separation of the recovered liquid may be required.
- Safe and effective operations at night will require floodlights that are positioned so that the work area is properly illuminated.

To use the Skimmer Selection Matrix, follow these steps:

- Step 1 Identify the environment in which a skimmer will be operated. Usually, only one environment will apply. Select those skimmers that perform well in the given environment (good rating, or ○).
- Step 2 Identify the type of oil that a skimmer will be required to recover. From the skimmers identified in Step 1, select those that have a good rating (○) for the oil viscosity of concern.
- Step 3 Choose the most important, applicable selection criteria and list these in order of priority. From the skimmers that have “passed” Steps 1 and 2, choose those with the highest rankings of the most important criteria.

Having identified one or more suitable skimmer types, consult the *World Catalog of Spill Response Products*, the *International Oil Spill Control Directory*, or other similar publications, to identify potential suppliers and to compare equipment specifications.

9.2.1 Skimmer Selection Example

A skimmer is required for an offshore area with a significant amount of debris. The oil will reach a medium-to-high viscosity after 24 hours of weathering. The skimmer must have a large built-in storage capacity to ensure that it can operate for extended periods without returning to shore to discharge recovered oil. The collected oil should be relatively water-free to conserve storage space.

- Step 1 From the matrix, we see that the following skimmers have a *good* rating in open water and in debris:
 - Rope mop
 - ZRV (zero relative velocity) rope mop
 - Sorbent lifting belt
- Step 2 Of these skimmers, the sorbent lifting belt is the best suited to the recovery of high viscosity oils, although rope mop and ZRV rope mop skimmers perform well in medium viscosity oils:
 - Sorbent lifting belt
 - Rope mop
 - ZRV rope mop
- Step 3 Choose a skimmer with internal storage:
 - Sorbent lifting belt
 - ZRV rope mop

The sorbent lifting belt skimmer would be the best choice because the oil will weather and become highly viscous.

9.3 Detailed Information on Skimmer Types

The following pages provide detailed operating information and performance characteristics of each skimmer type listed in Table 9-4.

9.3.1 Simple Weir

Operating Principle

Oil flows over a simple weir lip and is collected in a sump. Water is discharged through ports located below the weir. Some models have an onboard pump whereas others require a remote pump.

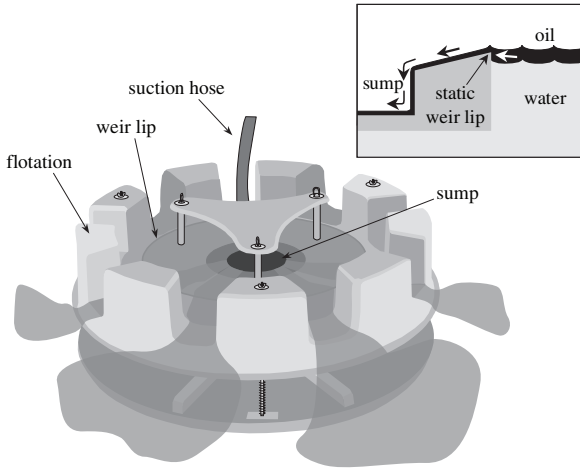

Figure 9-2 Simple Weir Skimmer

Expected Performance		
Low viscosity oil	Medium viscosity oil	High viscosity oil
○	○	●

Simple weir skimmers work well in thick layers of light, fresh crude oil. However, reflected waves inside containment booms combined with thin slicks can result in high water uptake. Once oil mixes with debris, weir skimmers may clog.

Operational Considerations

Mode	Sea State	Debris Tolerance	% Oil Recovery
Stationary	Calm	●	●

Since these skimmers recover large amounts of water, transferring with centrifugal pumps should be avoided because they will emulsify the oil. Diaphragm or peristaltic pumps are preferred when remote from the skimmer.

Advantages	Disadvantages
<ul style="list-style-type: none"> • Suitable for shallow water • Simple design/good reliability • Often compact • Easily deployed and operated • Lightweight 	<ul style="list-style-type: none"> • Weir may tilt, stop running, or operate poorly if suction hose connection or skimmer touches bottom • Can be clogged by debris • Does not recover high viscosity oil • Centrifugal pumps cause water/oil emulsions to form (can be used with other types of pumps)

9.3.2 Self-Leveling Weir

Operating Principle

Like a simple weir, these devices skim a discrete layer toward the top of a fluid. However, self-leveling weirs use a means of adjusting the weir's height. In the examples shown below, weir height changes as the pumping rate is increased or decreased and the fluid level in the sump changes.

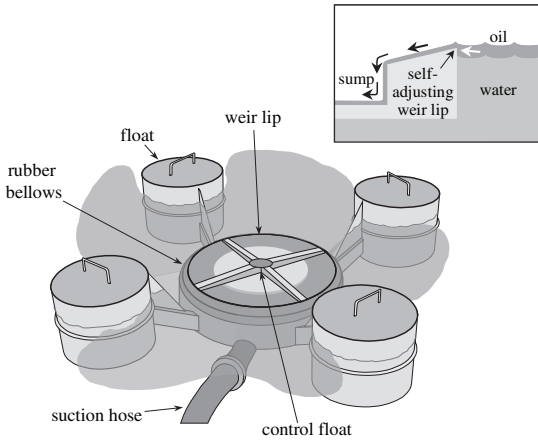

Figure 9-3 Self-Leveling Weir

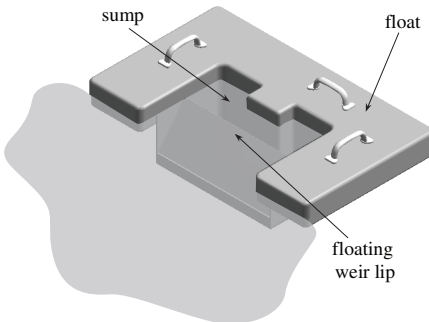

Figure 9-4 Self-Leveling Weir

Expected Performance		
Low viscosity oil	Medium viscosity oil	High viscosity oil
○	○	●

Self-leveling weir skimmers are generally more effective than simple weirs. The liquid recovery rate depends on the capacity of the off-loading pump; however, they are ineffective when oil becomes too viscous to flow over the weir.

Operational Considerations

Mode	Sea State	Debris Tolerance	% Oil Recovery
Stationary	Calm	●	◐

The flow of oil over a self-leveling weir can be optimized by adjusting the pump speed and/or by adjusting a valve on the suction line or air or hydraulic lifters to control the weir's height. Timed measurements of the oil phase collected in a storage container can be easily made to ensure optimum flow rates. Relatively high water content in the collected liquid should be expected in thin slicks (≤ 0.15 in or several mm).

9

Advantages	Disadvantages
<ul style="list-style-type: none"> • Can operate in shallow water • Simple design/good reliability • Easily deployed and operated • Some models have debris screens 	<ul style="list-style-type: none"> • Limited to calm water • May tilt or operate poorly if suction hose or base of skimmer touches bottom • Does not tolerate heavy oil; debris causes weir to clog • Models with centrifugal pumps emulsify recovered fluids • Rubber bellows in some models deteriorate over time

9.3.3 Weir with Integral Screw Auger

Operating Principle

A simple weir skims the top layer of fluid into a hopper directly connected to a reversible, horizontal (see inset below from Figure 9-5) or vertical (Figure 9-5) screw auger pump. Some newer models use a self-leveling weir. The screw pump drives, and is cleared by, a rotating scraper. The tightly fitted scraper seals the screw and creates a positive head at the pump discharge. Note that a number of other skimmer types, e.g., belt and brush systems, utilize a screw auger pump for transferring collected liquid and not as an integral part of the recovery mechanism.

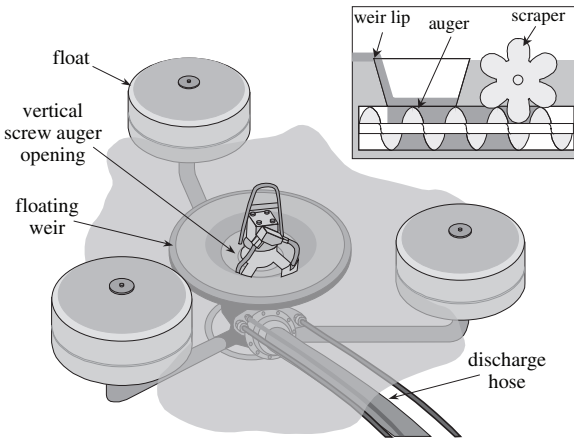

Figure 9-5 Weir with Integral Screw Auger

Expected Performance		
Low viscosity oil	Medium viscosity oil	High viscosity oil
●	○	●

Screw auger skimmers can recover heavy, viscous oils; however, oil must flow readily for these skimmers to function well. Some heavy (viscous) oils may not flow readily over the weir. They are also suitable for processing debris.

Operational Considerations

Mode	Sea State	Debris Tolerance	% Oil Recovery
Stationary	Calm	○	●

High water pickup (70–90%) should be expected and appropriate temporary storage/separation equipment must be planned for.

Advantages	Disadvantages
<ul style="list-style-type: none"> • Can operate in shallow water • Capable of pumping highly viscous oils mixed with debris, e.g., seaweed, ice, and wood chips • Screw auger pump neither requires priming nor forms oil/water emulsions • Easily deployed and operated 	<ul style="list-style-type: none"> • Limited to calm and protected water with heavy, viscous oils • Performance decreases in choppy water or low viscosity oils • Heavy oils that do not flow over the weir lip must be manually pushed into the collection hopper • Can develop high back-pressure in the discharge line

9.3.4 Advancing Weir

Operating Principle

Various advancing weir skimmers are available with similar characteristics. In most devices, an initial weir lip is advanced through a slick allowing water and oil to pass into a collection/separation chamber where oil is pumped from the surface. Water is discharged through ports below. Some models, as shown in Figure 9-6, incorporate water jets to induce the flow of oil over the weir lip. Other advancing weir skimmers use impellers or eductors to draw in oil.

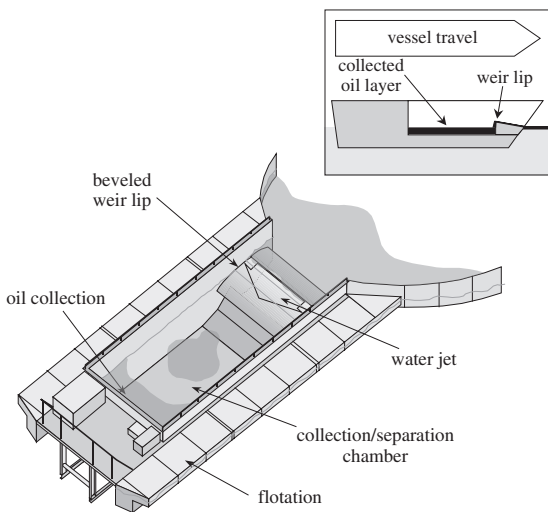

Figure 9-6 Advancing Weir Skimmer

Expected Performance		
Low viscosity oil	Medium viscosity oil	High viscosity oil
○	○	●

9

Advancing weir skimmers often use induced water flow to push oil into a containment/collection area. These units display high recovery rates in calm water and in light-to-medium viscosity oils.

Operational Considerations

Mode	Sea State	Debris Tolerance	% Oil Recovery
Advancing	Calm/protected	●	●

Maximum recovery rates are achieved when a water flow angle is low, i.e., directed almost straight back (towards the stern of the vessel). Advancing weir devices that do not include induced water flow systems usually experience difficulties in maintaining the continuous flow of oil into the skimmer.

Advantages	Disadvantages
<ul style="list-style-type: none"> • Work well in thick layers of low and medium viscosity oil • Can tolerate some debris • Water recovery reduced by allowing water to flow through collection chamber • Operation possible in slightly rougher conditions than typical weir skimmer due to water jet/weir design 	<ul style="list-style-type: none"> • Not effective in higher viscosity oils • Best used in calm or protected water • Processing problems with large debris • Jet induction affected by waves and currents • Units without induced water systems may not maintain continuous oil flow

9.3.5 Weir Boom

Operating Principle

The boom is towed in a catenary shape into a slick or anchored to allow oil to be carried into it by water current and wind. Skimming weirs (horizontal slots) are built into several sections of boom at the apex. Collected oil is pumped to a vessel for storage. Various models are available including single-vessel units with boom-supported side-sweeps as well as smaller systems designed for coastal and harbor use. Although the model depicted below has a water-filled ballast chamber and inflatable flotation, weir booms with internal foam flotation and regular skirts have been produced.

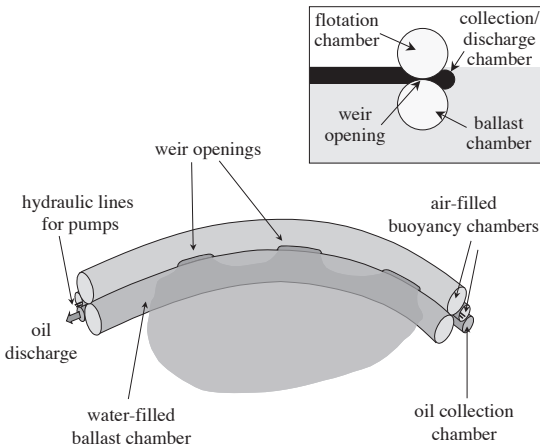

Figure 9-7 Weir Boom Skimmer

Expected Performance		
Low viscosity oil	Medium viscosity oil	High viscosity oil
○	○	●

Weir boom skimmers are generally capable of recovering light-to-medium viscosity oils. Although more effective in skimming thick slicks, weir booms can be used to concentrate and recover thin slicks. These skimmers generally require water depths of 4 to 5 ft (1.2 to 1.5 m) and should be towed at speeds of less than 1 kt (0.5 m/s).

Operational Considerations

Mode	Sea State	Debris Tolerance	% Oil Recovery
Advancing	Calm/protected	●	◐

Weir boom skimmers are often difficult to deploy, operate, and retrieve. They collect large amounts of water so that temporary storage and/or use of an oil/water separator must be planned when they are being used. When applied to spills in coastal waters, deployment problems have been experienced with weir boom skimmers. Weir booms have had low oil recovery rates in thin slicks.

Advantages	Disadvantages
<ul style="list-style-type: none"> • Can tolerate small debris • High pickup rate • Good wave-following ability • Some older models were designed to fit in air-deployable containers • Integral oil/water separators in some older models 	<ul style="list-style-type: none"> • Limited to calm and protected water and thick oil slicks • Water depth of 4–5 ft (1.2–1.5 m) required • Generally exhibit low collection efficiency • Can be difficult to deploy and retrieve • Mechanically complex • Pumps that emulsify oil included in some models • Weir opening can be difficult to maintain at the optimum level • Collect large amounts of water

9.3.6 Drum

Operating Principle

One or more oleophilic drums that are driven by hydraulic, pneumatic, or electric motors are rotated downward into an oil slick. Recovered oil is then scraped off the drum(s) into a trough and, in some models, a sump. Either external or onboard discharge pumps are available. Some newer skimmers feature a mechanism to allow an operator to adjust the drum submersion depth.

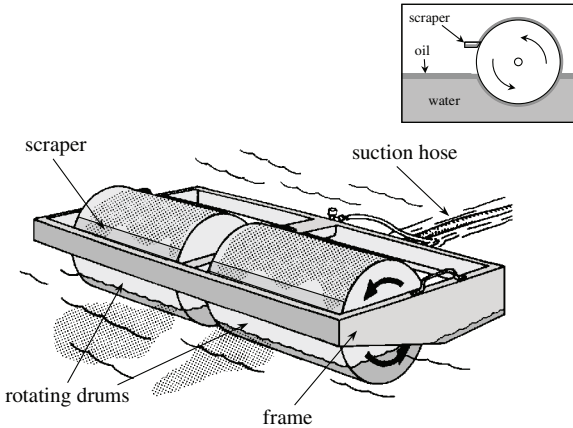

Figure 9-8 Drum Skimmer

Expected Performance		
Low viscosity oil	Medium viscosity oil	High viscosity oil
●	○	◐

Rotational speeds of approximately 40 rpm (revolutions per minute) result in the maximum recovery rate of medium viscosity oils. Reducing the rotational speed to 20 rpm generally improves the oil content in the recovered liquid by 10% but lowers the recovery rate by 50%.

Operational Considerations

Mode	Sea State	Debris Tolerance	% Oil Recovery
Stationary	Calm/protected	●	○

Waves often significantly decrease the recovery rate of self-contained (i.e., not vessel-mounted) drum skimmers. Calm water operation is recommended.

Advantages	Disadvantages
<ul style="list-style-type: none">• Small units can be operated in shallow water• Simple design/good reliability• Often compact (including onboard pump)• Many models can be lifted by 2 people• High oil/water pickup ratio• Can tolerate some debris• Can be used in calm, harbor, and some offshore applications	<ul style="list-style-type: none">• Limited to calm and protected water• Will not recover solidified/highly viscous oils due to pumping/oil flow problems• Will not recover dispersant-treated oil• Reduced recovery rate in thin slicks can occur if the drum water-wets• Limited capacity sump

9

9.3.7 Grooved Drum or Disc

Operating Principle

One or more oleophilic drums that are driven by hydraulic, pneumatic, or electric motors are rotated downward into an oil slick. The grooved disc skimmer replaces the flat discs (Section 9.3.8) with discs with shallow grooves and corresponding scrapers. A key difference is that this skimmer has a series of triangular-shaped grooves on the drums or discs (Figure 9-9). This pattern maximizes the surface area of the drum and allows menisci to be formed in the depth of each channel which increases the amount of recovered oil. Recovered oil is then scraped off into a trough and, in some models, into a sump. Either external or onboard discharge pumps are available.

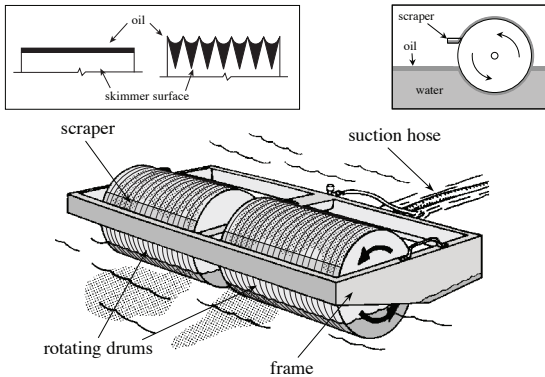

Figure 9-9 Grooved Drum Skimmer

Expected Performance		
Low viscosity oil	Medium viscosity oil	High viscosity oil
○	○	◐

Rotational speeds of approximately 65 rpm result in the maximum recovery rate of medium viscosity oils.

Operational Considerations

Mode	Sea State	Debris Tolerance	% Oil Recovery
Stationary	Calm/protected, limited offshore	●	○

Waves often significantly decrease the recovery rate of self-contained (i.e., not vessel-mounted) grooved drum skimmers. Calm water operation is recommended.

Advantages	Disadvantages
<ul style="list-style-type: none"> • Very high oil/water pickup ratio • Small units can be operated in shallow water • Simple design/good reliability • Often compact (including onboard pump) • Many models can be lifted by 2 people • Can tolerate some debris • Can be used in calm, harbor, and some offshore applications 	<ul style="list-style-type: none"> • Limited to calm and protected water • Will not recover solidified/highly viscous oils due to pumping/oil flow problems • Will not recover dispersant-treated oil • Limited capacity sump

9.3.8 Disc

Operating Principle

A series of oleophilic discs are arranged in a linear (i.e., single row), triangular (3 banks of discs), circular (“toroidal”), or square (4 banks of discs) configuration. Each group of discs is rotated downward into the oil, driven by hydraulic, pneumatic, or electric motors. PVC or aluminum scrapers remove oil adhering to the discs, and it flows down tubes or directly into a sump. Some smaller skimmers have external discharge pumps while other models have onboard pumps.

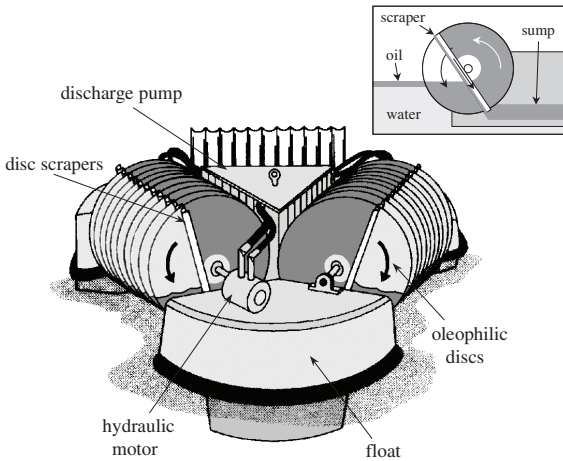

Figure 9-10 Disc Skimmer

Expected Performance		
Low viscosity oil	Medium viscosity oil	High viscosity oil
●	○	●

Disc skimmers recover liquid containing a high percentage of oil but can clog with debris. Down-tubes, scrapers, and discs should be cleaned frequently even when operating in what appears to be debris-free water.

Operational Considerations

Mode	Sea State	Debris Tolerance	% Oil Recovery
Stationary	Calm	●	○

A disc speed of approximately 40 rpm optimizes oil recovery rate in most oils. Light oils, e.g., diesel, may require a lower rpm to reduce water uptake. Skimmer operation is optimal in calm and low wave conditions, but deteriorates if there is splash against the discs or skimmer body.

Advantages	Disadvantages
<ul style="list-style-type: none"> • Small units can be operated in shallow water • Few moving parts/good reliability • Often compact • Models with onboard pump function well • Smaller units can be lifted by 2–3 people • High oil/water pickup ratio • Oil can be recovered from all directions by models with 3, 4, and circular banks of discs • Can be used in calm, protected, and some offshore applications 	<ul style="list-style-type: none"> • Not effective in heavy chop • Scrapers can be clogged by debris • Will not recover solidified/highly viscous oil • Will not recover dispersant-treated oil • Down-tubes may be clogged by heavy oil

9.3.9 Fabric-Coated Disc or Drum

Operating Principle

A series of fabric-coated oleophilic discs are arranged in a single row or in sets. The discs rotate downward into the oil, driven by hydraulic, pneumatic, or electric motors. PVC or aluminum scrapers remove oil adhering to the discs and it flows down tubes or directly into a sump. Some smaller skimmers have external discharge pumps while other models have onboard pumps. These pumps are essential to remove the high quantity of oil collected into the sump by the fabric coated discs. A similar system using drums has been developed as well.

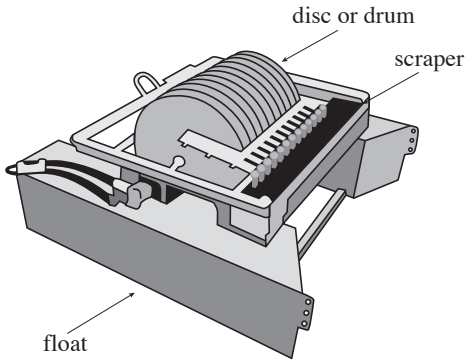

Figure 9-11 Fabric-Coated Disc Skimmer

Expected Performance		
Low viscosity oil	Medium viscosity oil	High viscosity oil
●	○	◐

Disc skimmers recover liquid containing a high percentage of oil but can clog with debris. Tubes, scrapers, and discs should be cleaned frequently even when operating in what appears to be debris-free water.

Operational Considerations

Mode	Sea State	Debris Tolerance	% Oil Recovery
Stationary	Calm, some offshore applications	●	○

A disc speed of approximately 40 rpm optimizes oil recovery rate in most oils. Light oils, e.g., diesel, may require a lower rpm to reduce water uptake. Skimmer operation is optimal in calm and low wave conditions, but deteriorates if there is splash against the discs or skimmer body.

Advantages	Disadvantages
<ul style="list-style-type: none"> • Very high oil/water pickup ratio • Small units can be operated in shallow water • Few moving parts/good reliability • Models with onboard pump function well • Smaller units can be lifted by 2-3 people • Can be used in calm, protected, and some offshore applications 	<ul style="list-style-type: none"> • Not effective in heavy chop • Scrapers can be clogged by debris • Will not recover solidified/highly viscous oil • Will not recover dispersant-treated oil • Tubes may be clogged by heavy oil

9.3.10 Rope Mop

Operating Principle

Single or multiple polyethylene fiber ropes are pulled through a slick by wringer-rollers. The rope mop is wrung and then continuously returned to the slick, repeating the cycle. Recovered oil is collected below the wringer assembly or pumped via a suction hose. Some models require a return pulley while those operated vertically are simply suspended above the slick so that the rope mop contacts the oil.

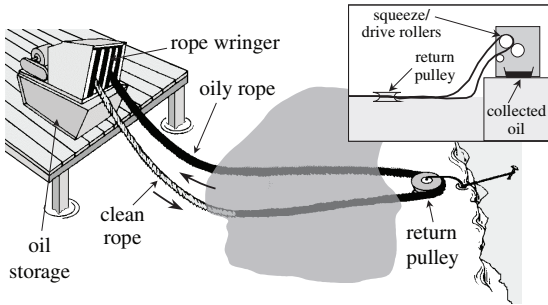

Figure 9-12 Horizontal Rope Mop Skimmer

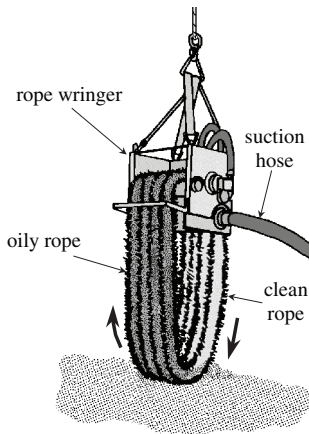

Figure 9-13 Vertical Rope Mop Skimmer

Expected Performance		
Low viscosity oil	Medium viscosity oil	High viscosity oil
●	○	●

Operational Considerations

Mode	Sea State	Debris Tolerance	% Oil Recovery
Stationary	All	○	○

Rope mop skimmers generally function best in warm weather (>68°F or >20°C) in medium viscosity oils that adhere to the mop. Operation in colder weather and lighter oils is possible, although the rope mop can freeze in low temperatures if it recovers water. The oil content in the collected liquid declines as mop speed exceeds about 1.25 ft/s (0.4 m/s).

Recovery in low waves of 1–2 ft (30–60 cm) should be possible. If oil is emulsified and viscous, rope mop strands can mat together and jam the wringer assembly. Low pickup rates of light oils, e.g., diesel, are common.

Advantages	Disadvantages
<ul style="list-style-type: none"> • Effective in calm, protected, and open water • Can operate in any water depth (and over dry patches) • Good pickup rate for medium viscosity oils • Wide, effective reach • Can tolerate most debris • Rope can recover oil in low currents • Can operate in broken ice 	<ul style="list-style-type: none"> • Ropes and wringer-rollers will wear if oil is mixed with sand • Inefficient unless oil is confined or pooled • Attachment points/lines required for tail (return) pulley (horizontal models only) • Tail pulley may have to be repositioned when tide changes • Not effective in highly viscous oil

9.3.11 Zero Relative Velocity (ZRV) Rope Mop

Operating Principle

The standard configuration of a ZRV rope mop skimmer consists of a series of oleophilic ropes mounted and pulled in between the hulls of a self-propelled catamaran vessel. The rope mops are operated so that they contact the oil/water surface at the same speed as the vessel encounters slicks, resulting in zero relative velocity between the rope mops and the oil. Therefore, ZRV rope mop skimmers are effective in high currents. Hydraulically-driven squeeze rollers wring out the oil-laden rope mops. These skimmers must be advanced through slicks. They do not function well in the stationary mode. Recovered oil is stored onboard the vessel until it can be off-loaded.

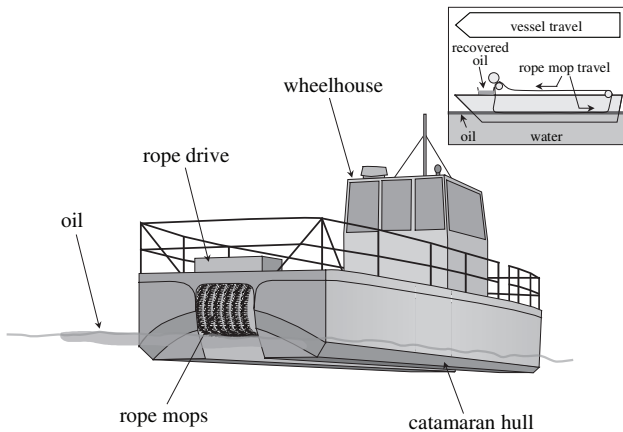

Figure 9-14 ZRV Rope Mop Skimmer

Expected Performance		
Low viscosity oil	Medium viscosity oil	High viscosity oil
●	○	●

ZRV rope mop skimmers function best in warm weather (>68°F or >20°C) in medium viscosity oil that adheres to the mop. Operation in colder weather and lighter oils is possible; however, the rope mops freeze at temperatures of 32°F (0°C) and below.

Operational Considerations

Mode	Sea State	Debris Tolerance	% Oil Recovery
Advancing	Open	○	○

Oil recovery in low waves of 1–2 ft (30–60 cm) should be possible. Rope mop strands can mat together and jam wringer assemblies in emulsified and/or viscous oil (Bunker C, weathered crude). Low pickup rates of light oils, e.g., diesel, should be expected.

ZRV skimmers can be operated in speeds up to 3 knots (5.5 km/hr).

Advantages	Disadvantages
<ul style="list-style-type: none"> • Effective in calm and protected water • Good oil recovery in oil slicks thicker than ¼ in (6 mm), e.g., in embayments or near ice edges • Good oil/water pickup ratio • Onboard oil storage • Generally, good working conditions for crew 	<ul style="list-style-type: none"> • Water depths greater than 3 ft (1 m) are required by most models • Difficult to transport to remote areas • A portion of some oils may flow by the rope mops and be left behind

9.3.12 Sorbent Lifting Belt

Operating Principle

An inclined oleophilic belt is advanced through a slick so that oil and debris are conveyed up the belt. Collected debris is scraped off and oil adhering to the belt is squeezed from it. In some models, an induction pump is positioned behind a semi-porous belt located just below the waterline. The pump impeller draws liquid through the belt, forcing oil onto and into the belt.

Sorbent and non-sorbent belt skimmers have been designed that rely on a belt that moves down into the water. The downward moving belt is described in Section 9.3.13 and is referred to as the submersion plane/belt skimmer.

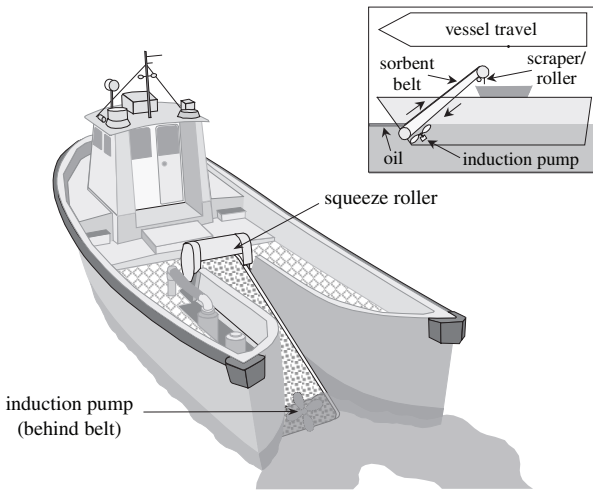

Figure 9-15 Sorbent Lifting Belt

Expected Performance		
Low viscosity oil	Medium viscosity oil	High viscosity oil
●	○	○

Sorbent belt skimmers display good recovery rates for both fresh and viscous, debris-laden oil. They can recover light sheens but the percent oil recovered is low.

Operational Considerations

Mode	Sea State	Debris Tolerance	% Oil Recovery
Stationary/ Advancing	All	○	●

Self-propelled barges outfitted with belt skimmers can be effective in nearshore recovery operations due to their mobility, high recovery rate and storage capacity. The percent oil recovered is low with some types of belt skimmers but heated tanks in some models allow recovered water to be readily separated from oil and decanted.

Advantages	Disadvantages
<ul style="list-style-type: none"> • Effective in calm, protected, and open water • Some types allow debris collection • High oil recovery rate • Larger, self-propelled models have onboard storage • Self-propelled models can be deployed to remote sites • Recover highly viscous oils • Effective in a wider range of oils than many other skimmers • Can be disassembled for transport 	<ul style="list-style-type: none"> • Larger units cannot operate in shallow water • Operation by qualified seamen required for larger models • Some models are mechanically complicated and difficult to maintain • Assembly of some models requires skilled mechanic and lifting gear • Belt life for some models can be relatively short • A portion of some oils may flow through the belt and surface behind these skimmers

9.3.13 Brush

Operating Principle

Closely spaced brushes collect oil, which is then removed by a comb-like scraper before being conveyed to storage. On some smaller models, brushes are mounted on a drum. Most larger models employ multiple linear chains deployed from the side (as shown below) or bow of a dedicated vessel or a vessel of opportunity. Side collectors require a jib, boom, multiple cables, and onboard storage and are often positioned on existing vessels used for multiple purposes, including spill response and fire fighting.

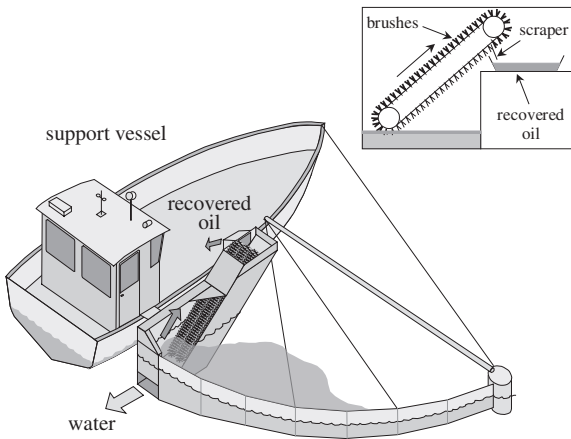

Figure 9-16 Brush Skimmer

Expected Performance		
Low viscosity oil	Medium viscosity oil	High viscosity oil
●	○	○

Operational Considerations

Mode	Sea State	Debris Tolerance	% Oil Recovery
Advancing	Open	○	●

Brush skimmers function optimally in medium and high viscosity oils, provided that a suitable pump is used to transfer the latter to storage. Highest oil recovery rates in viscous products occur when brush drums are operated at approximately 20 rpm. However, the percent oil recovered in the collected liquid is highest at 5 to 10 rpm. The higher oil content is achieved at the expense of oil recovery rate, which decreases in direct relation to the decrease in rpm.

Linear brushes work best at 1 ft/s (0.3 m/s). Their wave tolerance is generally good since water flows through the brushes, but response of the entire skimming system depends on the sea-worthiness of the working platform. Excessive movement of the brush packs in waves due to vessel pitch and roll reduces oil recovery rate, particularly if brush packs are bow-mounted (side collectors are more common). Light oils, e.g., diesel, are not effectively recovered with most standard brushes due to low recovery rate and percent oil recovered.

Advantages	Disadvantages
<ul style="list-style-type: none"> • Suitable for weathered or emulsified oil • Relatively simple mechanical design (e.g., comb/scrapper system) • Flow of oil into brushes not affected by waves if units are mounted on stable vessels • Can tolerate some debris 	<ul style="list-style-type: none"> • Low pickup rate of light oil • Oil losses under booms of side collectors possible • Bow-mounted collectors affected by vessel movement/ bow wave interference • Not effective in stationary conditions

9.3.14 Water Jet

Operating Principle

Nozzles on a pressurized pipe spray water over an inclined weir. Entrained water rises and carries oil over the weir lip. Once over the weir lip, a containment boom, skimmer sump or other oil collection system retains the oil.

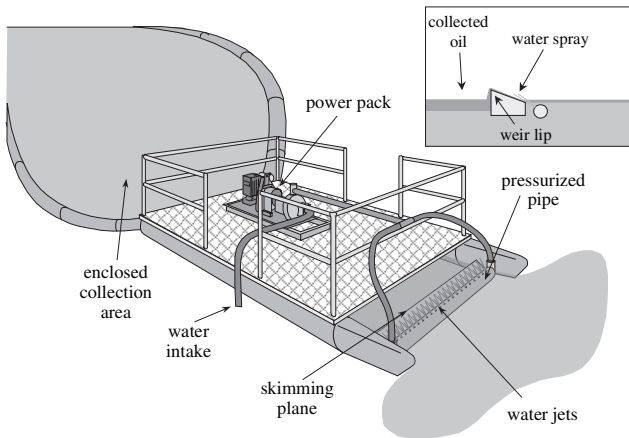

Figure 9-17 Water Jet Skimmer

Expected Performance		
Low viscosity oil	Medium viscosity oil	High viscosity oil
○	○	○

The water jet skimmer system functions by directing, confining, and concentrating slicks in a boom or other enclosed collection area so that the oil can be more efficiently recovered. As such, this skimming system is normally used in calm water.

Operational Considerations

Mode	Sea State	Debris Tolerance	% Oil Recovery
Stationary	Calm	●	●

Water jet skimmer systems can concentrate oils spanning a wide range of viscosity. However, high viscosity oils can be difficult to recover due to pumping problems.

Advantages	Disadvantages
<ul style="list-style-type: none">• Integral, closed boom of some systems provides large storage area• Good oil/water separation achieved in storage area if sufficient residence time is allowed before pumping• Induces oil flow into the skimmer (including slicks in inaccessible areas)• Not affected by small debris• Gentle collection generally does not emulsify oil although some time may be required to allow separation	<ul style="list-style-type: none">• Reduced performance in choppy water• Requires sufficient power to operate water jets• Does not work well in sub-freezing temperatures• Oil removal is required from the collection area using a skimmer or vacuum system• Emulsification of oil can occur in some models

9.3.15 Submersion Plane/Belt

Operating Principle

As the skimmer advances, oil is forced downward by a plane or moving belt (Figure 9-18). Once past the belt, the buoyancy of the oil causes it to rise up into a collection well from which it is pumped to onboard storage. Water leaves the collection well through a flow control gate (Figure 9-18 inset). Variations of this skimmer type have been designed that include porous plane and oleophilic belt elements.

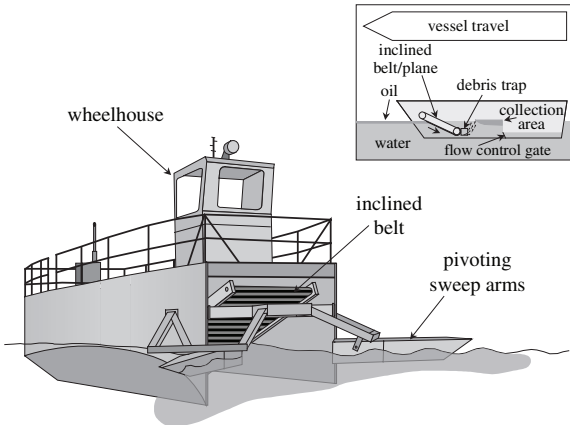

Figure 9-18 Submersion Plane/Belt Skimmer

Expected Performance		
Low viscosity oil	Medium viscosity oil	High viscosity oil
●	○	●

Submersion plane/belt skimmers are effective in medium viscosity oils. Skimming in currents up to 3 kts (up to 1.5 m/s) is possible with some submersion plane models. Oils that are neutrally buoyant can pass under the collection well and escape recovery.

Operational Considerations

Mode	Sea State	Debris Tolerance	% Oil Recovery
Advancing	Open	●	●

Due to limited onboard storage in many models, recovered liquid must be pumped to support vessels. These skimmers can be relatively difficult to maintain since some components are mechanically complex.

Advantages	Disadvantages
<ul style="list-style-type: none">• Suitable for medium viscosity oils• Can tolerate some debris and ice	<ul style="list-style-type: none">• Debris that passes through the debris trap can impede recovery and requires messy, onboard removal• Less effective for both light and heavy oil• Skimming performance can be affected by vessel movement/bow wave effects

9.3.16 Rotating Vane

Operating Principle

A rotor with a series of vanes rotates beneath the water surface and draws oil towards the weir lip. Water passes through the vanes and is discharged below the skimmer. Recovered oil collects in a sump and is then pumped to remote storage.

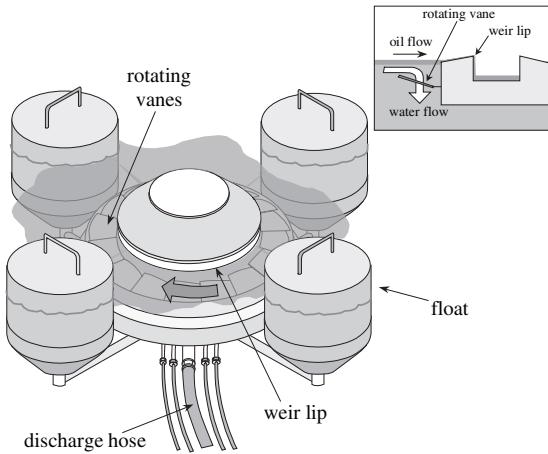

Figure 9-19 Rotating Vane Skimmer

Expected Performance		
Low viscosity oil	Medium viscosity oil	High viscosity oil
○	○	◐

Rotating vane skimmers pick up light-to-medium viscosity petroleum products. High viscosity oils either flow under the skimmer or can accumulate on the rotors.

Operational Considerations

Mode	Sea State	Debris Tolerance	% Oil Recovery
Stationary	Calm	●	●

Skimmers that induce flow to collect oil are generally effective in thick layers of low-to-medium viscosity oil in calm water. Waves can disrupt the desired flow pattern and prevent the entry of oil into the system.

Advantages	Disadvantages
<ul style="list-style-type: none">• Lightweight, can be easily deployed and retrieved• Capable of drawing oil from several feet (1 meter) away• Work best in thick, contained oil• The shipping container of one version also serves as an oil/water separator	<ul style="list-style-type: none">• When operated in thick layers of high viscosity oil, recovery rate is limited in models that utilize a remote pump• Pumping rate must be closely monitored to avoid high water pickup because oil collection is hidden below the skimmer• Long stringy debris, e.g., kelp, can clog rotor• Waves and currents can interfere with the vanes

9.3.17 Paddle Belt

Operating Principle

A series of paddles mounted on a moving belt rotate downward into the slick and convey the oil and water held against a baffle underneath the belt into a collection/separation tank. The collected mixture is allowed to separate and the water is discharged.

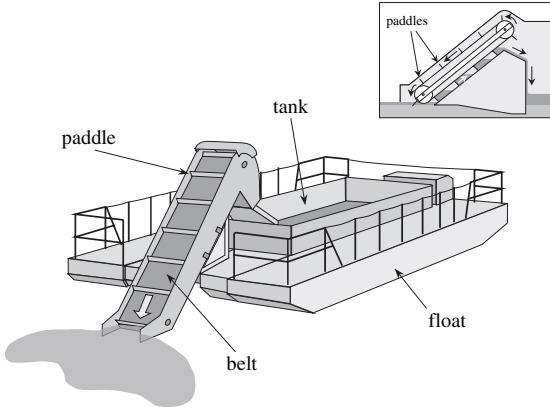

Figure 9-20 Paddle Belt Skimmer

Expected Performance		
Low viscosity oil	Medium viscosity oil	High viscosity oil
●	○	○

Operational Considerations

Mode	Sea State	Debris Tolerance	% Oil Recovery
Stationary	Calm	○	○

Paddle belt skimmers are well suited to recovery of viscous oil and debris in calm water. These skimmers recover large amounts of water if the belt is rotated too quickly or in waves.

Advantages	Disadvantages
<ul style="list-style-type: none">• Effective in contained oil with medium or high viscosity• Can tolerate most types of debris and some ice• High recovery rate in thick oil layers• Adjustable skimming head allows deployment of belt over booms	<ul style="list-style-type: none">• Perforated plate models can be clogged by long, stringy debris• Limited to the recovery of high viscosity oils in calm water• Pick up high percentage of water in thin slicks

9.4 Material Take Off (MTO) List

There are a number of types of equipment required to successfully deploy and maintain skimming operations.

Table 9-5 Material Take Off List for Skimmers

Equipment	Use
Skimmers	Oil recovery
Booms	Oil containment
Pumps/hoses	Oil transfer
Storage	Temporary storage
Fittings	Connecting hoses, pumps, skimmers
Heaters	Assist in oil recovery
Tools	Setup, repair, maintenance
Rope	Positioning of skimmers
Cable	Positioning of skimmers
Vessels	Deployment/positioning of skimmers
Generators	Power for lights, heat, communications
Floodlights	Night-time operations
Oil-water separators	Reduction of oily wastes
Demulsifiers	Oil-water separation
Aircraft	Slick spotting, positioning of skimmers
GPS	Positioning skimmers, activity documentation
Sorbents	Cleaning equipment
Protective equipment	Protection of personnel
Crane/Davit	Used to raise and lower heavy equipment

10 Sorbents

10

10.1 Introduction

Sorbents are used to recover small amounts of oil through **absorption**, the penetration of oil into the sorbent material, and/or **adsorption**, the adherence of oil onto the surface of sorbent material. To enhance recovery, most sorbents are both oleophilic (attract oil) and hydrophobic (repel water).

Use of sorbent materials on large spills on water is generally limited by five factors:

- Logistics of applying and retrieving sorbents on wide-spread slicks
- Labor-intensive nature of the operation
- Relative high cost (versus small skimmers)
- Relative low recovery rates
- Large amount of solid waste generated

In general, use of sorbents is only appropriate during the final stages of a cleanup or to aid in the removal of thin films of oil. Sorbents can also be used to clean up secondary spills, and protect and/or clean environmentally sensitive areas, such as turtle egg-laying areas or marshes, where the use of other cleaning methods is restricted because of the damage they could cause.

10.2 Selection Criteria

10 All sorbents are effective to some extent. To optimize selection of a particular sorbent product, the properties of a sorbent must be tailored to fit spill conditions. Sorbents that may be useful in one situation may be less desirable in another. In an emergency situation, however, use whichever sorbent is handy until a preferable one can be obtained. Parameters to be considered are discussed below.

10.2.1 Capacity

- Oleophilic and hydrophobic properties are desirable.
- Sorbents should have a high oil/water sorbing ratio when used in water.
- Field sorbent capacity is likely to be less than test data indicate. It may require approximately 25% more sorbent than suggested.
- Suitability of sorbent material depends on oil type and degree of weathering.

10.2.2 Rate of Sorption

- Light oils are sorbed rapidly.
- Sorption time required for saturation is much longer for viscous oils.
- Rate and effectiveness of sorption are proportional to the surface area of sorbent exposed to oil.
- Recovery rate decreases as the oil film becomes thinner. Booms can contain and thicken an oil layer to enhance the use of sorbents.

10.2.3 Buoyancy

- High buoyancy permits sorbents to float for long periods (days or weeks), even when saturated with oil and water.
- Some natural fibers, such as straw and peat moss, have high initial buoyancy but become waterlogged and sink.
- Excessive buoyancy may reduce efficiency to the point that sorbents need to be forced down into the oil to saturate them.

10.2.4 Oil Retention

- Some sorbent materials release much of the oil when the saturated sorbent is lifted out of the water.

10.2.5 Effect of Dispersants

- Dispersants prevent oil from sticking to a sorbent's oleophilic surface.

10.2.6 Suitable Uses

- Matted, lightweight (50 g to 200 g (2–7 ounces) per sheet) sorbent can be blown off the oil surface in strong winds. Two to three sheets in layers are more effective in windy conditions.
- Distribution of sorbents on oil contained in booms can effectively suppress waves and prevent the oil from splashing over the boom.

10.2.7 Reusability

- Reusable sorbents reduce waste.
- Some sorbents work better when “primed” or previously wetted with oil.
- Repeated handling and the need for wringers and storage containers increase the difficulty of applying reusable sorbents.

10.2.8 Ease of Retrieval

- Recovery of floating sorbents is very difficult but may be achieved by use of fishing techniques (such as seining nets) or some belt skimmers, provided they are not prone to clogging.
- Retrieval problems preclude use of uncontained particulate and loose sorbents on water.

10.2.9 Biodegradability

- In situations where material is difficult to recover, a sorbent should be environmentally safe and biodegradable.
- Sorbent products that incorporate nutrients can enhance biodegradation; however, the need for nutrients should be determined to avoid creating a eutrophic environment.

10.2.10 Disposal

- Sorbent selection should consider the ultimate disposal plan.
- Disposal facilities, whether for burial or incineration, generally need to be approved by regulatory authorities prior to the disposal of sorbents.
- Bag and/or drum requirements for storage of recovered sorbents should be calculated based on the quantity of sorbent to be distributed and the volume of oil likely to be sorbed.
- Sorbents must be burnable and not contain too much water for incineration.

The latest edition of the *World Catalog of Oil Spill Response Products* includes a listing of currently available sorbent materials and their suppliers. Also useful are sorbent test results from Environment Canada (Environment Canada, 1991, in Selected References Section of this manual).

Composition of sorbents can be grouped into three main types:

- Synthetic
- Organic
- Inorganic







Synthetic materials, such as polyethylene and polypropylene, generally offer superior oil recovery efficiency compared to organic and inorganic materials, such as peat moss or vermiculite. Typical materials and suitable applications are presented in Table 10-1.

Table 10-1 Sorbent Selection Matrix

Sorbent Type	Typical Materials	Considerations for Use
Synthetic	<ul style="list-style-type: none"> • Polyethylene/polyurethane foams and pads • Polypropylene fabric, nets and ribbons • Nylon fabrics and strips • Polyester/cotton fabrics (windshield cleaner cloth) 	<ul style="list-style-type: none"> • Generally the most effective (some absorb up to 25 times their weight of oil); highly oleophilic/hydrophobic • Available in many forms: rolls, sheets, blankets, open netting, pom-poms, loose, etc. • Not biodegradable but most are environmentally safe (inert) • White or light-colored products are preferred for oil visibility; avoid black/dark colors • High surface area products are good for application to viscous oils • Some products are treated with surfactants to enhance oleophilic properties • Some are reusable
Organic	<ul style="list-style-type: none"> • Straw • Peat moss • Sawdust • Coconut fiber • Chicken feathers • Cork • Cellulose fiber • Biodegradable sponge • Ground corn cobs • Wool • Wood chips 	<ul style="list-style-type: none"> • Generally absorb 5–10 times their weight • Biodegradable • Have been used to immobilize oil in sensitive environmental areas (e.g., marshes) to protect vegetation and wildlife • Some products are treated to enhance oleophilic properties • Many sink fairly rapidly when soaked • Primarily loose materials that are difficult to recover
Inorganic	<ul style="list-style-type: none"> • Perlite • Vermiculite • Glass wool • Volcanic rock 	<ul style="list-style-type: none"> • Generally absorb 3–6 times their weight • Relatively inexpensive • Difficult and sometimes hazardous to apply • Some sink and cannot be recovered

10.3 Types of Sorbents

Sorbents are fabricated from various materials in many forms. Examples are shown below. Linear materials, such as pads, rolls, and boom, can be handled as one unit. Particulate sorbents consist of fine materials that are typically spread over the land and then recovered by scraping, raking or vacuuming. Other forms include loose fill that is spread over the spill and recovered mechanically.

	Boom <ul style="list-style-type: none">• sorbent material, cylindrically-shaped and deployed like a boom• some models have ballasted skirt and flotation core
	Pads <ul style="list-style-type: none">• sheets of sorbent material available in various configurations, e.g., melt-blown, sonic-bonded, laminated and air-laid
	Pillows <ul style="list-style-type: none">• sorbent material enclosed in a small sack, which can be easily handled and placed in confined areas
	Pom-poms <ul style="list-style-type: none">• bunches of oleophilic strips• can be strung together on a rope as a snare boom
	Rolls <ul style="list-style-type: none">• continuous sheet of sorbent material
	Sweeps <ul style="list-style-type: none">• long sheets of sorbent material, reinforced with rope and stitching
	Other <ul style="list-style-type: none">• other forms include socks, barriers, loose fill, and particulate

10.4 Application

Wide use of sorbents is limited by the intensive labor required, the amount of solid waste generated and other factors listed in Section 10.1. Suitable application of sorbent includes:

- final recovery of residual spilled oil in nearshore areas or locations inaccessible to vessels and equipment
- rapid containment of or response to small, inshore spills while slicks are fresh and relatively thick
- cleaning and wiping lightly-oiled surfaces, such as short segments of rocky shoreline
- covering boat decks, piers, walkways, etc. to prevent contamination of vessels, vehicles, offices or any designated “clean” area
- protecting or cleaning of environmentally sensitive areas, such as turtle egg-laying areas or marshes, where other cleaning methods are restricted because of the damage they could cause

Application techniques for commonly used sorbents are shown in Table 10-2.

Table 10-2 Sorbent Material Application Techniques

Sorbent	Technique
Pads (squares and strips)	<ul style="list-style-type: none">• Placed in confined areas to collect small quantities of oil. They should be left for several hours in spilled oil for greater effectiveness• Pads can be wrung out with a simple wringer and re-used
Rolls	<ul style="list-style-type: none">• Used in the same manner as squares and strips, but usually more convenient since they can be either torn or cut to an optimum length• Very effective in protecting walkways, boat decks, working areas, previously uncontaminated or cleaned areas; can be used to cover areas used as temporary storage sites for oily materials• Disposal is facilitated by rolling-up the sorbent and placing it in a suitable container

Table 10-2 Sorbent Material Application Techniques (continued)

Sorbent	Technique
Boom	<ul style="list-style-type: none"> • Can serve a dual function by absorbing and containing oil, but only effective in very calm waters • Most effective on thin films of oil • Tightly compacted sorbent material encased in mesh restricts oil penetration, requiring a boom to be rotated and moved around in the oil to work efficiently. It is usually better to drive oil into the boom. • Solid “sausage” boom is better than loosely packed “pop-corn” (granular) boom. Loosely packed granules absorb more water and mesh bags break easily, requiring additional cleanup effort. • Can be used effectively to protect sheltered areas against oil contamination; also can be deployed behind skimmers to collect excess or missed oil, but not generally effective when used this way • Disposal is accomplished by folding, rolling, and/or stuffing a boom into plastic bags for disposal.
Pom-poms and snare booms	<ul style="list-style-type: none"> • Most effective on viscous or weathered oil • May be used to recover oil both on shore and in the water • Can be strung together and placed in intertidal area to recover oil • Can be used to seal the shore end of a boom so that no oil escapes. This is particularly useful in tidal waters, especially where the bottom is rocky or strewn with boulders. • Often used as a composite barrier inside a containment boom to limit the escape of oil under varying wind, wave and current conditions • Disposal is accomplished by stuffing the material in a plastic bag for disposal
Loose materials	<ul style="list-style-type: none"> • Loose sorbent materials are not recommended for use in spills on water; however, loose organic materials have been successfully used to stabilize stranded oil in remote locations.

10.5 Solidifiers

Solidifiers are typically polymeric products that react with oil to bind it into a cohesive mass, immobilizing it and reducing the rate of spreading and thinning. They have been successfully used on small harbor spills of light products and on spills to land. If applied to oil on water, the solidified mass may float until fishnets, perforated shovels or other pickup devices can physically remove it from the water. Because solidifiers are applied as powders, granular mixes, or gels, they are generally impractical for wide-scale application at large spills.

The following points summarize the strengths and weaknesses of solidifiers:

- unlike sorbents, solidifiers must generally be registered with and approved for use by government agencies
- large amounts of solidifier material (10–40% by weight of the oil mass) must be applied for full effectiveness
- solidifiers are most effective on light oils and at higher temperatures
- solidifiers can reduce the vapor emission rate of oil but care must be taken in storing solidified oil because hydrocarbon vapors can still build up over time
- some sinking agents market themselves as solidifiers; sinking agents should not be used on an oil spill
- solidifiers are effective in either a fresh or sea water environment
- most solidifiers are readily combustible so incineration is a feasible disposal option

11 Transfer Systems

11.1 Introduction

In oil spill response, transfer systems include pumps and means of transport of recovered oily waste. This chapter focuses on pumps because of their importance on initial oil recovery.

Pumps are used during oil spill response to transfer oil, water, emulsions, and dispersants. Recovered liquids typically need to be transferred:

- From a skimmer to interim storage
- From interim storage to a transportation vessel/vehicle
- From a transportation vessel/vehicle to a final storage/disposal facility

Preplanning recovered oil transfer is critical to ensure continuity of oil spill response operations.

Transfer systems must be selected to suit the quantities and types of liquids being moved. Although a wide range of pumps can be used for fresh, unemulsified oils, pump options can become limited as transfer conditions become more difficult. Careful consideration must be given to each specific transfer situation, particularly in the case of long-term mechanical recovery operations since over time, oil weathers, viscosity increases, and debris is collected.

Pumps may be used to off-load unspilled oil from stricken vessels (called “lightering”) and to transfer dispersants from drums and temporary storage tanks to dispersant application systems.

Generally, spill cleanup does not require pumps with extreme capabilities. The head through which the pump must push liquid is usually about 6 to 20 ft (2 to 6 m) and suction lift from a skimmer to a pump is often much less (i.e., only a few feet or about a meter). In some cases, a large head is required, especially when oil is pumped from a skimmer to a large, unballasted barge or storage vessel. In this case, the head required may be 30 ft (10 m) or more.

Some pumps are more suitable for oil spill work for the following reasons:

- They self-prime and maintain prime if used on a skimmer and the skimmer rolls.
- There is provision for draining when shut down. This is essential in cold weather.
- Pumping capacity is steady even with slight increases in oil viscosity.
- Cavitation does not occur when pumping warm or high viscosity oil.
- Emulsification of water in oil and water is not increased by pump design.
- Debris tolerant.
- Parts are oil-resistant.

Pumping viscous oils may be difficult as friction caused by the oil traveling down a hose may reduce flow. To help minimize pressure loss, an annular injection flange may be connected to the discharge hose. The flange allows the injection of a small layer of water or steam around the oil passing through the hose reducing the total pressure loss. See Section 11.3.12 Annular Injection for more information.

11.2 Pump Selection Matrix

The Pump Selection Matrix in Table 11-1 lists 13 generic types of transfer pumps that are generally available worldwide and 15 selection criteria for them. An overall evaluation of each pump follows the table.

To use the Pump Selection Matrix, follow these steps:

- Step 1 Identify the type of fluid and/or debris that needs to be transferred. Select pumps that will perform well in moving such material(s).
- Step 2 Identify other criteria critical to the situation (e.g., portability) and rank them in order of importance. Search the Matrix for these criteria in descending order of importance, each time selecting the highest rated pump(s) which have not been eliminated in a previous step.

11.2.1 Pump Selection Example

A pool of highly viscous, weathered oil has collected in a remote swampy area. During the recovery process, it is likely that a considerable amount of silt and other small debris will be picked up with the oil. An example of the process of selection is as follows:

- Step 1. The area and conditions suggest that the most feasible oil removal method is a pump. Although rated “good” for handling silt, the vacuum truck is excluded because of its size and difficulty in gaining access to the site. The portable pumps best suited to moving highly viscous fluids are:
 - Lobe
 - Gear
 - Intermeshing Screw
 - Screw/auger
 - Progressive Cavity
 - Reciprocating
- Step 2. Because this is a difficult transfer operation, silt/sand and debris requirements take priority over transfer rate. Of the pumps picked in Step 1, only two have a rating of “good” for handling silt/sand:
 - Screw/auger
 - Progressive cavity
- Step 3. If there is a possibility of gravel being present, then the screw/auger pump should be chosen because of its higher tolerance for this type of debris. For drawing suction from distance, the progressive cavity is the preferred choice. Pump availability should then be verified.

Table 11-1 Pump Selection Matrix

	Characteristics of Transfer System															Notes
	Fluid Type			Debris Tolerance			Other Criteria									
	High Viscosity	Medium Viscosity	Low Viscosity	Silt/sand	Gravel/particulate	Seaweed, stringy material	Transfer rate	Low emulsification tendency	Ability to run dry	Ability to operate continuously	Self-priming	Suction head	Back pressure/head	Portability	Ease of repair	
Centrifugal	●	○	○	○	○	●	○	●	○	○	●	●	●	○	○	5 8
Lobe	○	○	●	●	●	●	●	●	●	●	●	●	○	●	●	2
Gear	○	○	●	●	●	●	●	●	●	●	●	●	○	●	●	2
Intermeshing Screw	○	○	●	●	●	●	●	●	●	●	●	●	○	●	●	2
Rotary Vane	●	●	●	●	●	●	●	●	●	●	●	●	●	●	●	-
Flexible Impeller	●	●	●	●	●	●	●	●	●	○	○	●	●	●	●	6
Screw/auger	○	○	●	○	○	●	●	○	●	●	●	●	●	●	●	1
Progressive Cavity	○	○	●	○	●	●	●	○	●	●	○	○	○	●	●	2
Reciprocating	○	○	●	●	●	●	●	●	○	●	●	○	○	●	●	2 4
Diaphragm	●	●	●	○	●	●	●	●	○	●	●	●	●	●	○	1 3 7
Peristaltic	●	○	○	○	○	●	○	○	○	○	○	○	○	○	○	-
Annular Injection	○	○	○	○	○	●	○	○	N	●	N	N	N	○	○	-
Vacuum Truck	○	○	○	○	○	○	●	○	○	●	○	○	N	●	●	-
Air Conveyor	○	○	○	○	○	○	●	○	○	●	○	○	N	●	●	-

Legend ○ Good ● Fair ● Poor N = Not Applicable

Notes:

- Normally have remote power sources — are safe around flammable fluids
- Should have a relief valve in the outlet line to prevent bursting hoses
- Air-powered models tend to freeze-up in sub-freezing temperatures
- Units with worn ball valves are difficult to prime
- Some remotely-powered models are designed to fit inside a tanker's Butterworth hatch
- Can also pump air at low pressure
- Transfer is pulsating rather than continuous
- High shear action tends to emulsify oil/water mixtures

11.3 Detailed Information on Pump Types

11.3.1 Centrifugal Pump

Operating Principle

Liquid enters a pump at the center of a rapidly rotating fan-shaped impeller. Centrifugal force then accelerates fluid toward the impeller's outer edge. From there, the fluid exits through a nozzle on the periphery of the impeller housing. Pressure generated by this pump is from the kinetic energy imparted to fluids by the impeller.

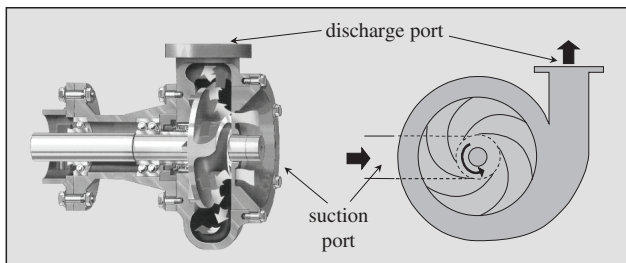

Figure 11-1 Centrifugal Pump

Suitable Uses

- Pumping low viscosity fluids at high rates for short distances
- Supplying water to dispersant spray booms or fire nozzles
- Flooding shoreline with seawater to prevent oil from sticking to soil
- Unloading drums of chemicals, fuels, etc.
- Mixing demulsifier chemical into emulsified oil

11

Advantages	Disadvantages
<ul style="list-style-type: none">• Small, lightweight, easy to handle• High capacity with low viscosity fluids• Inexpensive, considering output capability• Mechanically simple (one moving part)• Tolerant of most debris• Easy to repair in the field	<ul style="list-style-type: none">• Output decreases markedly with increasing viscosity of fluid• Many models are not self-priming• May generate oil/water emulsions• Pump performance impaired by stringy debris

11.3.2 Lobe Pump

Operating Principle

Incoming fluid fills cavities between the lobes of two rotating elements and becomes trapped where two adjacent lobes seal against a wall of the pump housing. As lobes rotate, trapped fluid is carried to the pump outlet. When a leading lobe loses contact with a wall, oil trapped in the cavity is forced out of the pump. This means that pumping rate is a function only of rotational speed. This pump shows little or no decrease in pumping rate with increasing fluid viscosity. Because very high pressure can develop in the discharge line, the outlet side should be equipped with a relief valve to prevent a discharge hose from bursting when viscous fluid is pumped at a high rate.

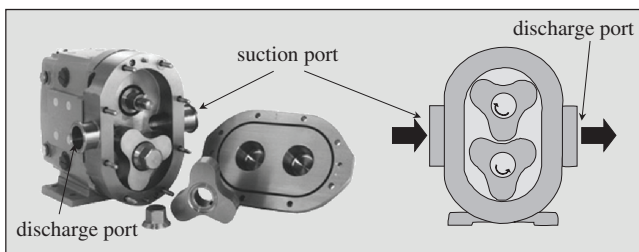

Figure 11-2 Lobe Pump

Suitable Uses

- Mixing viscous emulsions with demulsifier chemicals
- Pumping clean, solids-free fluids
- Feeding viscous emulsions to incineration devices
- Metering dispersant into spray boom systems

Advantages	Disadvantages
<ul style="list-style-type: none">• Pumps high viscous fluids at a constant rate• Pumps against high back pressure• Gear-driven models can be run dry without serious damage	<ul style="list-style-type: none">• Relatively slow pumping rate• Most models cannot tolerate sand or other abrasive debris• Non gear-driven models cannot be run dry

11.3.3 Gear Pump

Operating Principle

A gear pump works on the same principle as a lobe pump. It usually has close tolerances and many points of metal-to-metal contact. For this reason, a gear pump cannot process large particulate matter or highly abrasive solids. Most gear pumps are bi-directional.

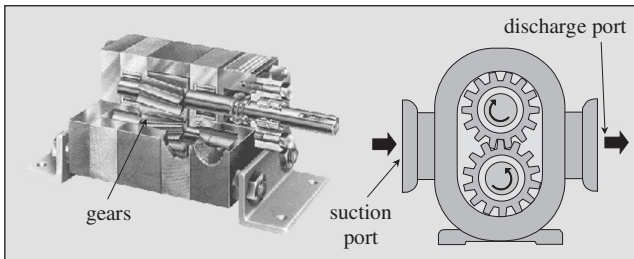

Figure 11-3 Gear Pump

Suitable Uses

- Mixing viscous emulsions with demulsifier chemicals
- Pumping clean, solids-free fluids
- Feeding viscous emulsions to incineration devices
- Metering dispersant into spray boom systems

11

Advantages	Disadvantages
<ul style="list-style-type: none">• Pumps very viscous fluids at a constant rate• Pumps against high back pressure• Gear-driven models can be run dry without serious damage	<ul style="list-style-type: none">• Relatively slow pumping rate• Most models cannot tolerate sand or other abrasive debris• Non gear-driven models cannot be run dry

11.3.4 Intermeshing Screw Pump

Operating Principle

Intermeshing screw pumps are very similar to gear pumps, but the area of contact between gears is higher in the screw pump. They are especially well suited for pumping clean viscous fluids at high pressures. Intermeshing screw pumps cannot tolerate abrasive solids.

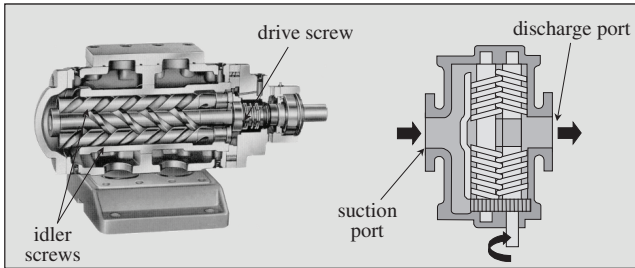

Figure 11-4 Intermeshing Screw Pump

Suitable Uses

- Mixing viscous emulsions with demulsifier chemicals
- Pumping clean, solids-free fluids
- Feeding viscous emulsions to incineration devices
- Metering dispersant into spray boom systems

Advantages	Disadvantages
<ul style="list-style-type: none">• Pumps very viscous fluids at a constant rate• Pumps against high back pressure• Gear-driven models can be run dry without serious damage	<ul style="list-style-type: none">• Relatively slow pumping rate• Most models cannot tolerate sand or other abrasive debris• Non gear-driven models cannot be run dry

11.3.5 Rotary Vane Pump

Operating Principle

A number of mechanical elements extend radially from a central rotating shaft and seal against the inner wall of the pump housing. A seal is accomplished by spring action. A rotating cavity fills with fluid that is transported from the inlet port to the outlet port by a 180° rotation of the central shaft. There is no clearance and because of metal-to-metal contact, vane pumps are sensitive to debris and abrasives.

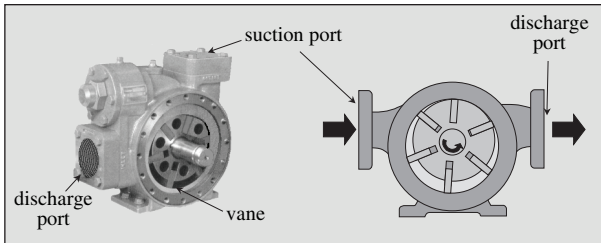

Figure 11-5 Vane Pump

Suitable Uses

- Pumping clean, solids-free fluids from offshore skimmers
- Emptying drums of chemicals or fuel
- Pumping seawater to dispersant spray booms
- Metering dispersant chemicals into spray boom systems
- Pumping oil and water from flexible storage containers to shoreline pits or incinerators

11

Advantages	Disadvantages
<ul style="list-style-type: none">• Small, compact, and easy to handle and repair• Efficiently pumps both low and high viscosity fluids	<ul style="list-style-type: none">• Cannot be run dry• Not available in a wide variety of sizes• Sensitive to abrasive solids

11.3.6 Flexible Impeller Pump

Operating Principle

A number of mechanical elements extend radially from a central rotating shaft and seal against the inner wall of the pump housing. A seal is accomplished by deforming the radial elements. A rotating cavity fills with fluid that is transported from the inlet port to the outlet port as the central shaft rotates. Flexible impeller pumps can deform around small, suspended particles and pass them without significantly reducing suction or pressure.

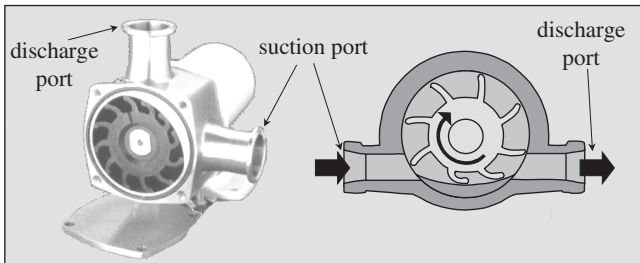

Figure 11-6 Flexible Impeller Pump

Suitable Uses

- Pumping fluids from offshore skimmers
- Emptying drums of chemicals or fuel
- Pumping seawater to dispersant spray booms
- Metering dispersant into spray boom systems
- Pumping oil and water from flexible storage containers to shoreline pits or incinerators

Advantages	Disadvantages
<ul style="list-style-type: none">• Self-priming• Can handle small suspended particulates• Small, compact, and easy to handle and repair in field• Efficiently pumps both low and high viscosity fluids	<ul style="list-style-type: none">• Cannot be run dry• Not available in a wide variety of sizes• Some models have impellers that are not oil-resistant

11.3.7 Screw/Auger Pump

Operating Principle

Oily material is gravity fed to a screw through a large hopper. As the screw rotates, it carries an oily mixture forward until a special rotary lobe scrapes oil from the groove and forces it out the front of a pump. Debris that fits between the “threads” of a screw is processed. A special cutter at the edge of a hopper can cut long stringy debris, so it can also be pumped. Because of its low rotational speed and the relatively loose clearance between screw, housing, and lobe, this pump has very little self-priming or suction capability.

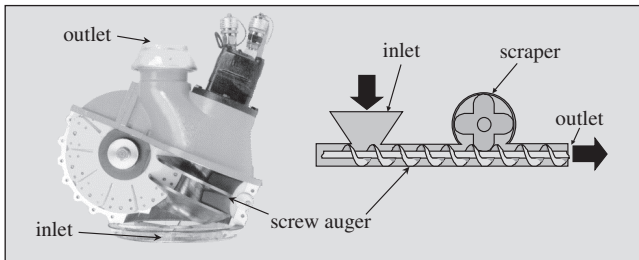

Figure 11-7 Screw/Auger Pump

Suitable Uses

- Pumping weathered crude or mousse
- Off-loading recovered oil from storage barges
- Transferring contents of earthen storage pits to incinerator
- Transferring oil/ice/snow slush

11

Advantages	Disadvantages
<ul style="list-style-type: none">• Can pump highly viscous or semi-solid materials• Processes most debris• Does not emulsify oil/water• Some models can be run dry• Some models are integral with a weir skimmer	<ul style="list-style-type: none">• Some models (with nylon casing) cannot be run dry• Not self-priming• Poor suction/lift capacity• Relatively low pumping rate for its power• Relatively expensive for capacity• Can develop high back pressure

11.3.8 Progressive Cavity Pump

Operating Principle

A spiral rotor turns inside a stationary chamber or stator to create pockets that move continuously towards the outlet. A rotor is a smooth, polished metal spiral or helix. A stator is similar in shape, but with only half the pitch of a rotor. It is made of a pliable, oil-resistant rubber, such as neoprene, Buna N, or polyurethane. As fluid enters a pump, it fills part of the cavity adjacent to the inlet. As the rotor turns, its specially shaped lobes seal against the stator and push fluid down the barrel in an advancing or progressing cavity. Pumping action is very gentle and tends not to emulsify oil and water. Depending on the size of cavities, this type of pump can pass solid particles, such as wood pieces, gravel, and ice, up to one inch (25 mm) in diameter. Because a stator is resilient, this pump can transfer fine abrasive solids effectively.

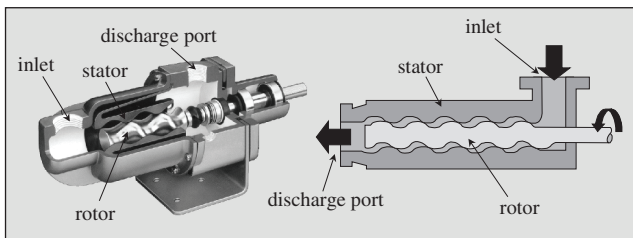

Figure 11-8 Progressive Cavity Pump

Suitable Uses

- Pumping viscous fluids at moderate rates against high back pressure
- Off-loading skimming vessels
- Transferring oil or emulsion from a skimmer to storage
- Pumping oily materials from storage pits to trucks, incinerators, etc.
- Miscellaneous pumping operations around the spill site

Advantages	Disadvantages
<ul style="list-style-type: none">• Pumps oil of various viscosities at a constant rate• Can handle most small debris• Self-priming• Does not emulsify oil/water	<ul style="list-style-type: none">• Large, heavy, awkward shape• Difficult to repair in field• Should not be run dry• Relatively low pumping rate

11.3.9 Reciprocating Pump

Operating Principle

A drive rod moves a diaphragm to one side of its housing, creating a vacuum in one chamber and pressure in the other. The vacuum opens one inlet valve and closes an outlet valve. When the rod reverses and moves the diaphragm to the other side of a housing, the action of all valves is reversed. Since liquid moves to the discharge port on both forward and reverse strokes of a rod at the same speed as the pump motor, a continuous discharge results.

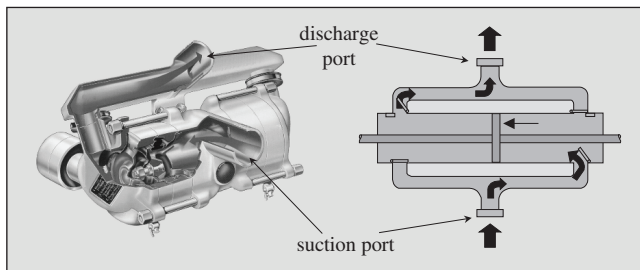

Figure 11-9 Reciprocating Pump

Suitable Uses

- Off-loading low and medium viscosity oils from skimming vessels or barges
- Injecting picked-up oil into incinerator devices

11

Advantages	Disadvantages
<ul style="list-style-type: none">• Can pump low to medium viscosity fluids at high pressures• Strong self-priming capability and good suction lift• Processes debris, i.e., small solids• Can be run dry for extended periods	<ul style="list-style-type: none">• Some models tend to “walk” if not tethered• Rubber diaphragms wear when exposed to fine abrasives, e.g., sand• Units with worn ball valves are difficult to prime

11.3.10 Diaphragm Pump

Operating Principle

As a diaphragm moves to one side of its housing, it creates a vacuum in one chamber and pressure in the other. The vacuum opens one inlet valve and closes an outlet valve. Pressure opens the other outlet valve and closes the remaining inlet valve. When a diaphragm moves to the other side of its chamber, the action of all valves is reversed. Pumping action gives rise to a slight pulsating discharge. A diaphragm pump has a flexible elastomer piston (diaphragm) with wide clearances between moving parts.

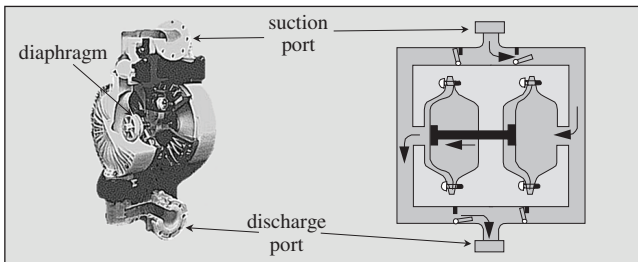

Figure 11-10 Diaphragm Pump

Suitable Uses

- Pumping fluid from small skimmer to nearby storage
- Pumping fluid in hazardous atmospheres (air-operated units)
- Pumping water and/or oil from storage containers to incinerators

Advantages	Disadvantages
<ul style="list-style-type: none">• Can run dry indefinitely• Can tolerate high concentrations of fine solids• Self-priming and gentle pumping action; good suction lift• Small, portable, easily repaired• Air-operated models are safe around flammable oil	<ul style="list-style-type: none">• Diaphragms sometimes burst• Models with worn ball valves do not self prime• Some diaphragm materials are not compatible with oil• Some models require compressor• Cannot operate against high back pressure• Single-acting pumps have strong pulsating action making them less desirable than double-acting pumps

11.3.11 Peristaltic Pump

Operating Principle

The pumping action of a peristaltic pump (also called a “hose pump”) is the result of alternate compression and relaxation of a specially designed resilient hose. A hose is compressed between the inner wall of the housing and the compression shoes of a rotor. A liquid lubricant in the housing minimizes sliding friction. The fluid being pumped is in contact only with the inner wall of a hose. During compression, abrasive particles in the fluid are cushioned in the thick inner hose wall, returning to the fluid stream after compression. This pump has no seats, seals, or valves. It is self-priming and can be run dry without damage. Suction, even for medium viscosity materials, is generally excellent.

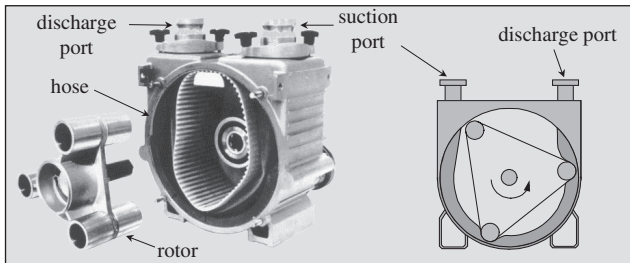

Figure 11-11 Peristaltic Pump

Suitable Uses

- Off-loading light emulsions from skimming vessels or oil storage barges
- Moving low and medium viscosity oils recovered in cold weather conditions as well as for more general use in warmer climates.

11

Advantages	Disadvantages
<ul style="list-style-type: none">• Can be run dry without damage• Can process low to medium viscosity oils• Can pass most debris up to 1 in (25 mm)• Flow reversal can be used to clear blocked hose• Easily repaired in field• Self-priming; good suction lift	<ul style="list-style-type: none">• Have pulsating flow• Internal hose wears and can require frequent replacement• Speed control can be difficult in medium viscosity oils• Vacuum on suction line can be lost on medium viscosity oils

11.3.12 Annular Injection

Operating Principle

Pumping flow rates can be adversely effected due to an increase in friction caused by three factors: (1) viscosity, (2) temperature, and (3) debris. An annular injection flange allows an operator to surround the oil within the hose with a layer of water or steam. This layer reduces the friction in the hose and allows for an increase in the distance that recovered oils are able to be pumped or the rate of pumping.

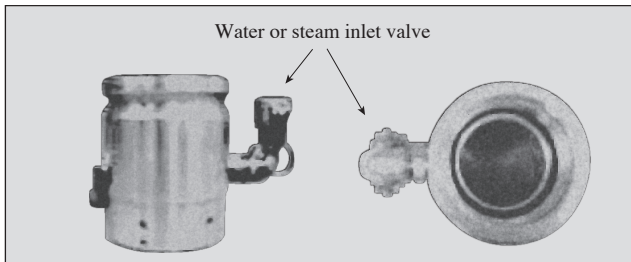

Figure 11-12 Annular Injection Flange

Suitable Uses

- To aid in transferring recovered oil in cold temperatures
- Assist in transferring viscous oil (e.g., emulsions) farther distances

Advantages	Disadvantages
<ul style="list-style-type: none">• Assist in transferring oily waste and recovered oil• Compact size and lightweight• Attaches to inlet or outlet side of pumps via camlock fittings	<ul style="list-style-type: none">• Not widely available• Secondary unit required to generate steam or pump water

11.4.1 Vacuum Truck

Operating Principle

Vacuum trucks are equipped with high vacuum pumps and a cylindrical chamber capable of sustaining very low internal pressures (i.e., about -14.5 to -12 psig [10–140 mm Hg absolute]). A vacuum is pulled on a chamber and a 3–4 in (8–10 cm) diameter hose is usually placed slightly below the surface of a slick. Depending on slick thickness, a mixture of oil and water enters the collection chamber. Positioning of the intake end of a hose is critical to minimize the amount of water collected. Floating weir skimmers can be attached to the inlet end of a hose to further reduce amounts of water recovered. In this case, a manual flow control valve may be useful.

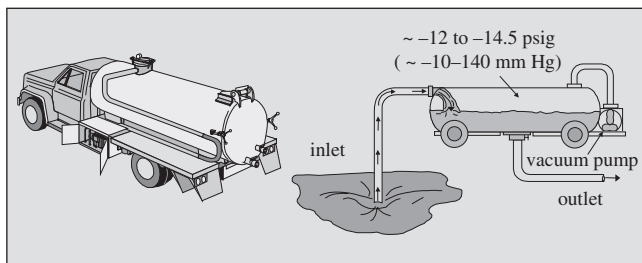

Figure 11-13 Vacuum Truck

Suitable Uses

- Off-loading viscous oil from skimming vessels or storage containers
- Providing suction for weir skimmers
- Removal of oil from boomed areas, earthen pits, flexible storage tanks, etc.
- Transporting recovered oil to a remote disposal site

Advantages	Disadvantages
<ul style="list-style-type: none"> • Normally readily available in industrialized areas • Can process a wide range of fluid viscosities • Provides transportation once oil is recovered • Does not emulsify oil/water • High pickup rate 	<ul style="list-style-type: none"> • Large and heavy; requires good roads • Slow recovery from loss of vacuum • High water pickup

11.4.2 Air Conveyor

Operating Principle

Portable air conveyors are considered vacuum devices although the amount of vacuum developed in a chamber is relatively low (about -6 to -4 psig [450–550 mm Hg absolute]). Oil and water are entrained in a high velocity (i.e., 150 miles/hr or 240 km/hr) air stream and are conveyed into a collection chamber. Because an air conveyor relies on a steady air flow, the inlet nozzle on an intake hose must be placed slightly above the fluid surface.

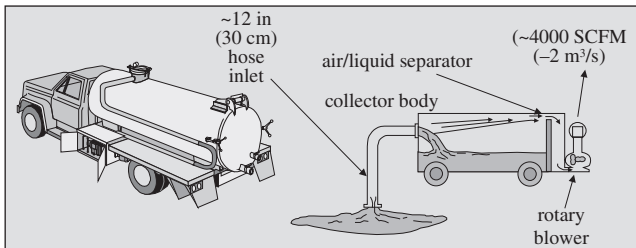

Figure 11-14 Air Conveyor

Suitable Uses

- Picking up weathered oil and tar balls from beaches or near shorelines
- Off-loading viscous oil from skimming vessels, pits, boomed areas, or debris-laden sites
- Moving oil vertically up to 30 ft (10 m)
- Recovery of used oil sorbents
- Providing supply air for portable incinerators

Advantages	Disadvantages
<ul style="list-style-type: none">• Can handle most debris• Can process a wide range of fluid viscosities• Can lift fluids up to 30 ft (10 m)• Does not emulsify oil/water• Provides transport of recovered fluids	<ul style="list-style-type: none">• Large and heavy; requires good roads• High water pickup• Difficult to make repairs in the field

11.4.3 Wheeled Vehicles

Operating Principle

In practically all oil spill cleanup operations, especially those conducted on or near land, a truck or some other type of wheeled vehicle eventually handles recovered oil and debris. Although vehicles are not usually thought of as transfer systems, they are essential in any cleanup operation. In planning response operations, it is important to match the type of vehicle to the service and road/soil conditions where it will be used. For instance, tank trucks can handle large volumes of water, oil and debris in any proportion. However, because of their heavy weight, they cannot be used on soft soil, unstable sand, or poor roads. Lighter trucks, vehicles with special tires for offroad travel, or light truck/trailer combinations are better suited for operation on beaches and poor roads.

Suitable Uses

- Carry fluids to storage or disposal sites
- Carry oily debris (logs, branches, vegetation, trash, etc.) to disposal sites
- Carry personnel and equipment around spill area

Advantages	Disadvantages
<ul style="list-style-type: none">• Can generally handle any type of oil, water, emulsion, or oily debris• Widely available• Spare parts and component repair services are usually available.• Can be used to transfer equipment and personnel	<ul style="list-style-type: none">• Limited transfer rate. The largest tank truck typically transfers only 100 barrels (16 m³) per load.• Large units must have good roads or hard stable soil surfaces on which to operate.• Some units, like flatbeds and pickup trucks, must have separate containers for the waste material they transfer.

11.5 Material Take Off (MTO) List

Various types of equipment are required to conduct transfer operations.

Table 11-2 Material Take Off List for Pumps

Equipment	Use
Pumps	Oily liquid transfer
Suction hoses	Removal of oil/water from skimmers
Discharge hoses	Transfer to storage
Storage	Temporary storage
Fittings	Connectors, adapters, clamps
Tools	Repair/maintenance
Rope	Lashing of pump, hoses
Spare parts	Various
Generators	Power
Water source	Provide steam or water for annular injection
Oil-water separators	Oil-water separation
Demulsifiers	Oil-water separation
Sorbents	Cleanup of equipment
Transport vehicles	Move and/or collect recovered oil

12 Shoreline Treatment

12

12.1 Introduction

The objective of shoreline treatment is to accelerate recovery of oiled shores while minimizing the impact of treatment operations. This approach is consistent with Net Environmental Benefit Analysis described in Section 1.

The selection of an appropriate shoreline treatment technique is based on many factors, including:

- Amount and type of oil
- Shoreline type
- Environmental or cultural sensitivity
- Logistics
- Waste generation
- Safety considerations
- Prevailing oceanographic and meteorological conditions
- Regulatory requirements

The first step in selection is to identify the amount and type/characteristics of the oil that has reached shore. Section 12.2 presents some guidance on how best to achieve this. The first step is shoreline assessment and there is considerable experience and knowledge available which would likely be employed to do this. Most experts use a form to capture the needed information and Section 12.2 describes all the data needed to record details of both the oiling and character of the shoreline. The next step is to select the most appropriate treatment method(s). Section 12.3 provides decision guides to facilitate this process.

Training in the proper use of mechanical equipment is essential for contractors and employees. Training is important to ensure safe operation and avoid accidents, improve oil recovery, minimize collection of clean material, and lessen the impact of equipment on a shoreline

A site safety plan must be followed and general safety precautions should be used. Generally, workers will be given a safety briefing designed for the environment they will be working in prior to entering the work area. PPE (Personal Protective Equipment) should be selected to match exposure hazards. Proper electrical grounding of equipment and the use of back-up warning signals are two additional important safety items.

Shoreline treatment options are summarized in Section 12.4 for each shore type. Following a brief review of natural recovery (Section 12.5), each physical treatment method is reviewed in terms of its primary use, physical and biological effects, and the logistical support required including equipment, personnel, and access (Section 12.6). Summaries for bioremediation, and chemical techniques are also presented (Sections 12.7 and 12.8, respectively).

12.2 Assessment of Shoreline Oiling

The following information is used to assess shoreline oiling and its implications for response:

- Shoreline types and coastal character (geologic character and ecological conditions of affected shorelines)
- Amount and properties of an oil that has reached shorelines (possible interactions between any stranded oil and the environment)
- Ecological, cultural, archaeological, human use, or economic constraints/priorities.

Outputs from assessment surveys are used to develop and implement shoreline treatment plans. During a major oil spill, shoreline oiling must be rigorously assessed before selection of appropriate treatment methods.

Shoreline assessment teams can be used to survey and document affected areas to then provide rapid geographic information on the locations and extent of shoreline oiling conditions. A form is usually employed to ensure that shorelines are characterized uniformly. Figure 12-1 and Table 12-1 present, as an example, the form used by NOAA in the US. The oiling summary form should be completed by a team of experts from a variety of organizations and specialties; e.g., geomorphologist, oil spill specialist, intertidal biologist, and archaeologist. Using a form helps provide a systematic approach to data collection that yields consistent data to aid comparisons among sites. A sketch can be drawn to locate specific oil deposits relative to major features.

Information which can be collected includes:

- General Information, such as date and time of survey, tide height, and some means of labeling or coding the various beach segments for later reference.
- Survey Team members and expertise.
- Some position data on where the segment is. GPS can be helpful, if available.
- Type of shoreline, e.g., rocky, sandy, muddy, wetland, etc. Table 12-1 has some code information which may be useful.
- Amount and distribution of oil on both the surface and subsurface.
- Observations as to sensitivity of the segment, either culturally or ecologically
- Any wildlife issues?

SHORELINE CLEANING ASSESSMENT FORM			
1. GENERAL INFORMATION		Date (dd/mm/yy)	Time (24th standard/day/light)
Segment ID:		hrs to	hrs
Segment Name:			
Survey By: Foot / Boat / Helicopter / Overlook / Other:		Sun / Clouds / Fog / Rain / Snow / Windy	
2. SURVEY TEAM No. _____	Name _____	Organization _____	Phone Number _____
3. SEGMENT	Total Length _____ m/yd	Length Surveyed _____ m/yd	Differential GPS Yes / No
Start GPS: (if applicable)	LAT _____ deg. _____ min.	LONG _____ deg. _____ min.	
End GPS:	LAT _____ deg. _____ min.	LONG _____ deg. _____ min.	
4. SHORELINE TYPE: Select only ONE Primary (P) and ANY Secondary (S) types present			
Rocky Cliffs		Exposed Tidal Flats	
Exposed Man-Made Structures		Exposed Vegetated Tidal Flats	
Wave-cut Platforms		Sheltered Rocky Coasts and Clay Scarps	
Fine-Medium Grained Sand Beaches		Peat and Lowland Flats	
Coarse Grained Sand Beaches		Sheltered Tidal Flats	
Tundra		Salt Marshes and Mangroves	
Gravel and Cobble Beaches		Sensitive Habitats (Coral Reefs, Kelp, Seagrass, etc.)	
5. OPERATIONAL FEATURES			
Direct backshore access? Yes / No		Oiled Debris? Yes / No Type _____ Amount _____ bags	
Access restrictions _____			
Alongshore access from next segment? Yes / No		Suitable backshore staging? Yes / No	

Table 12-1 Example Shoreline Oiling Summary
(Adapted from US National Oceanic and Atmospheric Administration)

SHORELINE CLEANING ASSESSMENT FORM (continued)																					
6. SURFACE OILING CONDITIONS				Begin with "A" in the lowest tidal zone																	
Zone ID	Tidal Zone			Oil Cover		Oil Thickness				Oil Character											
	LI	MI	UI	SU	Length m/ft	Width m/ft	Distr. %	PO	CV	CT	ST	FL	FR	MS	TB	TC	SR	AP	No		
7. SUBSURFACE OILING CONDITIONS				Use letter of Zone location plus Number of trench, e.g., "A1"																	
Trench No.	Tidal Zone			Trench Depth cm/in	Oiled Interval cm-cm/in-in	Subsurface Oil Character				Water Table cm/in	Sheen Color B, R, S, N	Clean Below? Yes / No									
	LI	MI	UI			SU	OP	PP	OR				OF	TR	No						
8. COMMENTS				Cleanup Recommendations; Ecological / Recreational / Cultural Issues / Wildlife Observations																	

Sketch: Yes / No Photos: Yes / No (Roll # _____) Frames _____ Video Tape: Yes / No (Tape # _____)

12

Table 12-1 Example Shoreline Oiling Summary (continued)
(Adapted from US National Oceanic and Atmospheric Administration)

Table 12-1 Example Shoreline Assessment Form Codes
(Source: NOAA)

SHORELINE ASSESSMENT FORM EXPLANATIONS

Calibration and consistency ARE VERY IMPORTANT! Do a calibration exercise to make sure that all teams are consistently using the same terminology and estimations.

Units: Use either metric (m, cm) or English (yd, ft, in). Circle the units used.

Tide Height: Circle the two letters indicating the progression of the tidal stage during the survey.

Sect. 3 SEGMENT SURVEY LENGTH

Always record both lengths on the first survey, especially where the team creates the segments in the field. On repeat surveys, always enter in the Survey Length, especially if only part of the segment is surveyed. Measure in meters or yards. If, applicable, GPS may be used to record ends of segments.

Sect. 6 SURFACE OILING CONDITIONS

Zone ID: Use a different ID for each different oil occurrence, e.g., two distinct bands of oil at mid-tide and high-tide levels, or alongshore where the oil distribution changes from 10% to 50%. Describe each different occurrence on a separate line.

Tidal Zone: Use the codes to indicate the location of the oil being described, as in the lower (LI), mid (MI), or upper (UI) intertidal zone, or in the supra (SU) tidal zone (above the normal high tide level).

Oil Distribution in tidal zones: Enter the estimated percent of oil on the surface, or codes for the following intervals:

C	Continuous	91–100% cover
B	Broken	51–90%
P	Patchy	11–50%
S	Sporadic	<1–10%
T	Trace	<1%

Figure 12-1 Example Shoreline Assessment Form Codes (continued)
(Source: NOAA)

Surface Oil Thickness: Use the following codes:

PO	Pooled Oil (fresh oil or mousse >0.4 in. (~1 cm) thick)
CV	Cover (oil or mousse from >0.04 in (0.1 cm) to <0.4 in. (~1 cm) on any surface)
CT	Coat (visible oil <0.1 in (0.1 cm), which can be scraped off with fingernail)
ST	Stain (visible oil, which cannot be scraped off with fingernail)
FL	Film (transparent or iridescent sheen or oily film)

Surface Oil Character

FR	Fresh Oil (unweathered, liquid oil)
MS	Mousse (emulsified oil occurring over broad areas)
TB	Tarballs (discrete accumulations of oil <10 cm in diameter)
TC	Tar (highly weathered oil, of tarry, nearly solid consistency)
SR	Surface Oil Residue (non-cohesive, oiled surface sediments)
AP	Asphalt Pavements (cohesive, heavily oiled surface sediments)
NO	No oil (no evidence of any type of oil)

SUBSURFACE OILING CONDITIONS

Oiled Interval: Measure the depths (from the sediment surface to top/bottom of subsurface oiled) layer. Enter multiple oil layers on separate lines.

Subsurface Oiling Descriptors: Use the following codes:

OP	Oil-Filled Pores (pore spaces are completely filled with oil)
PP	Partially Filled Pores (the oil does not flow out of the sediments when disturbed)
OR	Oil Residue (sediments are visibly oiled with black/brown coat or cover on the clasts, but little or no accumulation of oil within the pore spaces)
OF	Oil Film (sediments are lightly oiled with an oil film, or stain on the clasts)
TR	Trace (discontinuous film or spots of oil, or an odor or tackiness)

Sheen Color: Describe sheen on the water table as brown (B), rainbow (R), silver (S), or none (N).

Because the predominant grain size and substrate(s) in a section of oiled shoreline largely determine treatment methods, shoreline types are usually categorized in terms of their geologic character. The following shore types are used in this Manual as the basis for selecting treatment methods (Sections 12-3 and 12-4) (See also Table 6-1):

- Bedrock and wave-cut platforms
- Man-made solid structures and boulder beaches
- Fine-to-medium grain sand beaches
- Coarse-grain sand beaches
- Tundra cliffs
- Gravel and cobble beaches
- Riprap
- Exposed tidal flats
- Exposed vegetated tidal flats
- Sheltered rocky coasts and clay scarps
- Peat and lowland tundra
- Sheltered tidal flats
- Salt marshes and mangroves
- Sensitive near-shore and offshore habitats (coral reefs, lagoons, kelp beds, and seagrass beds)

12.3 Shoreline Treatment Decision Guides

Once a consensus is reached on the character of a shore and the nature of oiling, appropriate treatment methods can be selected. Figures 12-2 through 12-5 indicate potentially applicable treatment techniques, with the most preferred method listed first. If the first technique cannot be used, then the next one should be selected.

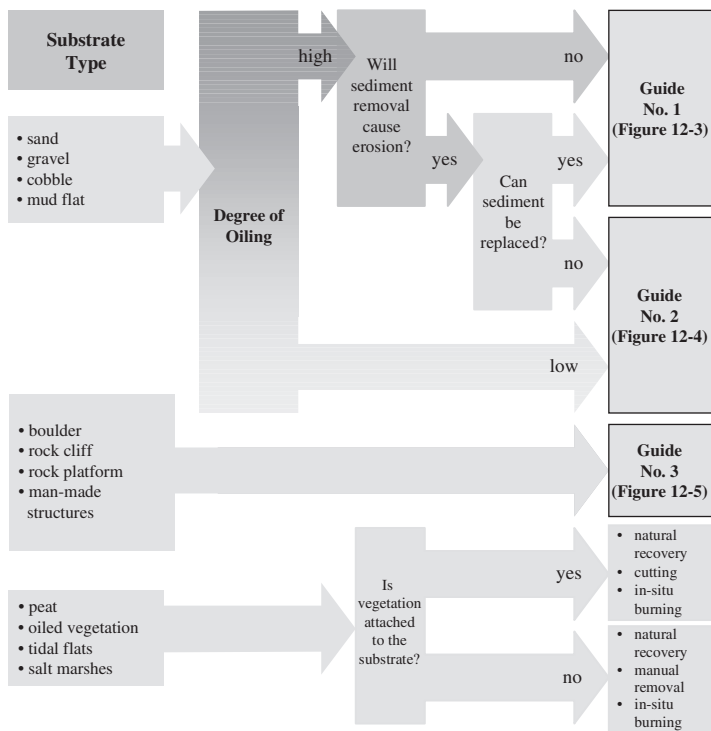

Figure 12-2 Shoreline Treatment Guide Key

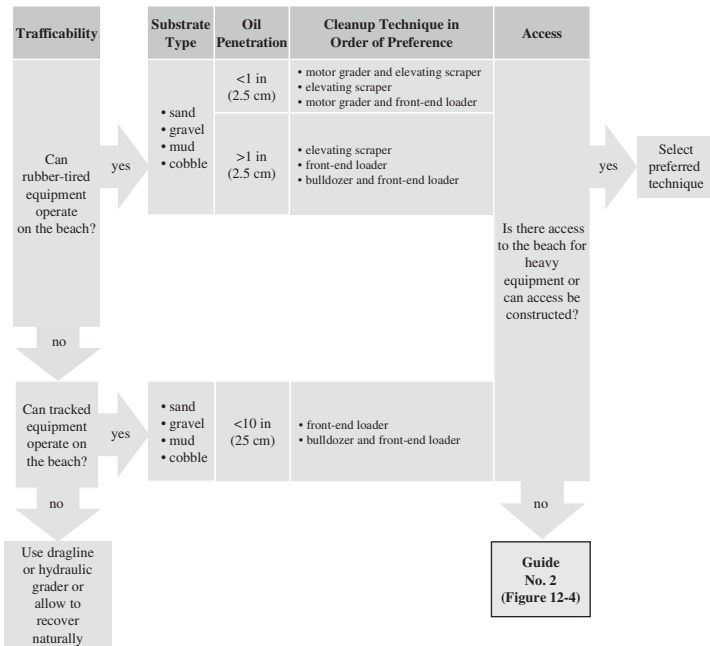

Figure 12-3 Shoreline Treatment Guide No. 1

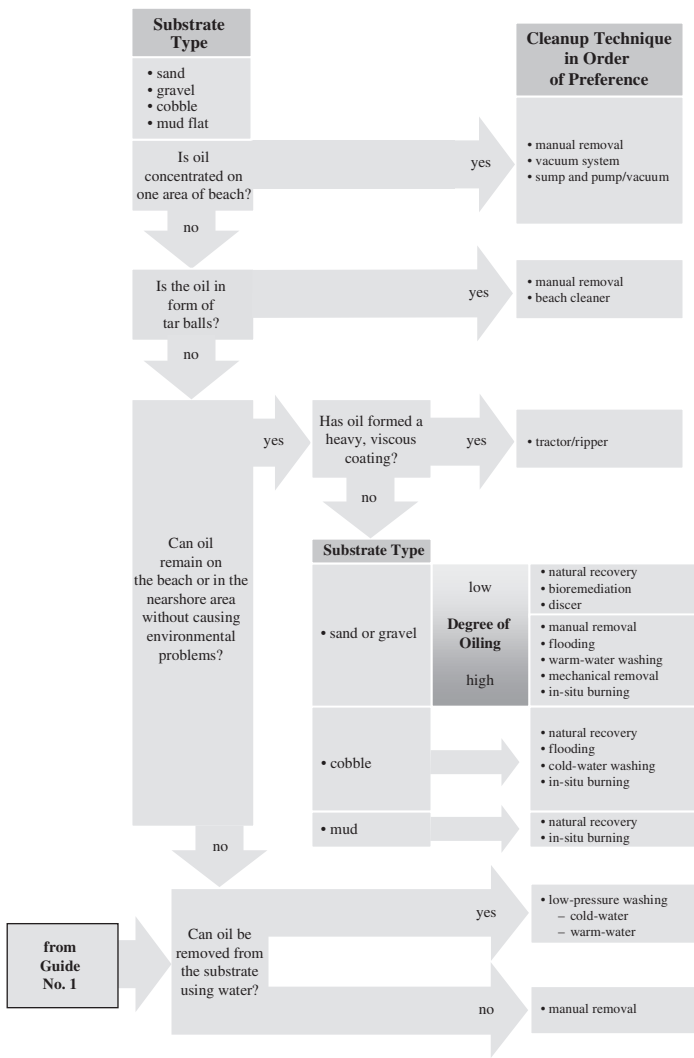

Figure 12-4 Shoreline Treatment Guide No. 2

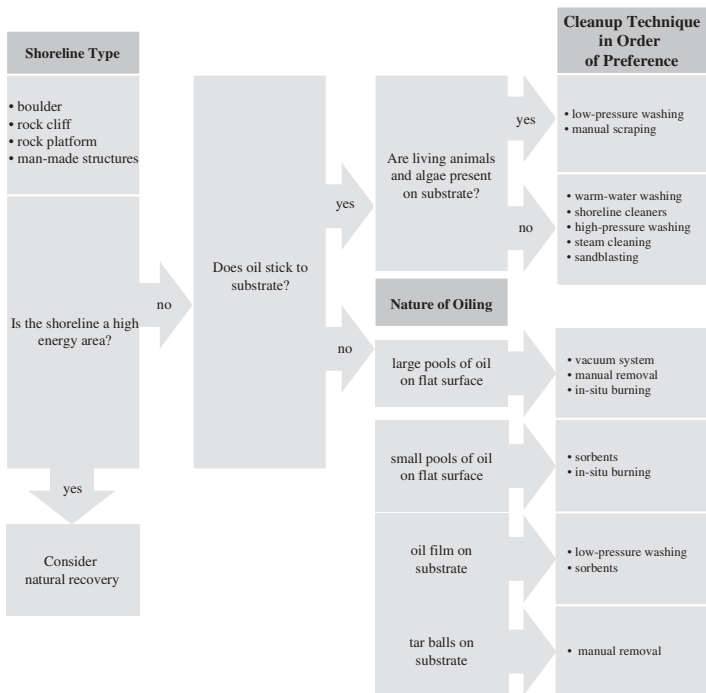

Figure 12-5 Shoreline Treatment Guide No. 3

12.4 Treatment of Shoreline Types

Because many variables affect selection of treatment options, the decision-making process requires insights not provided in the Decision Guides. Table 12-2 supplements the Decision Guides by summarizing treatment options according to shoreline type. Further, note the following:

- Spray or flood from shore only when lower intertidal zones are under water.
- Do not spray freshwater on intertidal communities.
- Heat and hot water can affect organisms. Use with caution.
- Minimize foot traffic where organisms may be trampled.

Table 12-2 Treatment Options by Shore Type

Shore Type	Treatment Options
Exposed Rocky Headlands and Wave-Cut Platforms	<ul style="list-style-type: none">• Natural recovery is preferred for light-medium oils that reach exposed coasts. Stranded, light oil may be rapidly removed by wave action. Light oil in sheltered areas is often removed by waves within weeks. Heavy oil can collect in hollows and be present for a significant time if not removed.• Vacuums are effective for light, medium and heavy oils that collect in tidal pools and hollows (unsafe for gasoline).• Flooding with water from a perforated pipe or hose without a nozzle is appropriate for light oils. Prevent oil flow downslope into lower intertidal zone.• Low-pressure, cold-water washing can also be used on light-medium oils. Washing from a boat or barge eliminates effects on organisms from foot traffic. Prevent oil flow downslope into lower intertidal zone. Contain and collect oil using booms and skimmers or sorbents.• Use high-pressure, cold-water washing on viscous oils that cannot be removed by low-pressure washing.• Manually remove small amounts of medium-heavy oils. Use low-pressure, warm/hot water wash on more viscous oils that cannot be removed by cold water.• Shoreline cleaners and chemicals may be used prior to flooding or low-pressure washing. Contain and collect recovered oil.• For steep cliffs, specially-designed omni-booms are the safest means of washing off oil.

Table 12-2 Treatment Options by Shore Type (continued)

Shore Type	Treatment Options
<p>Man-Made Solid Structures and Boulder Beaches</p>	<ul style="list-style-type: none"> • Natural recovery is preferred for light-medium oils that reach exposed coasts. Stranded, light oil may be rapidly removed by wave action, although heavy oil can persist for some time and may collect in hollows. Light oil in sheltered areas is often removed by waves within weeks. • Manually remove small amounts of medium-heavy oils. • Apply dispersants or other cleaning agents on small amounts of oil during flooding tide in countries that approve this procedure. • Flooding from a perforated pipe or a hose without a nozzle is appropriate for light oils. Do not allow oil to flow downslope into lower intertidal zone. • Low-pressure, cold-water washing can also be useful for light-medium oils. Washing from a boat or barge eliminates effects on organisms from foot traffic. Do not allow oil to flow downslope into lower intertidal zone. Contain and collect oil using booms and skimmers or sorbents. • Low-pressure, warm/hot water washing can remove more viscous oils that are not affected by cold water. • Use high-pressure, cold-water washing on more viscous oils that cannot be removed by low-pressure washing. • Use high-pressure, warm/hot water washing, steam cleaning, or sandblasting for surfaces where no organisms are present. • High-pressure, warm/hot water washing may remove viscous oil from stonework and plaster. Do not use abrasives (e.g., sandblasting) or chemicals on these surface types if damage might result. Consult government agencies when cleaning historic structures.

Table 12-2 Treatment Options by Shore Type (continued)

Shore Type	Treatment Options
<p>Fine- to Medium-Grained Sand Beaches</p>	<ul style="list-style-type: none"> • Natural recovery is preferred for small spills of light-medium oils on exposed or remote coasts. • Tilling/aeration or sediment relocation accelerates degradation and natural removal of light oils. • Mechanical removal is appropriate for long sections of beach with high concentrations of surface oil, provided that the operation can limit the removal of non-contaminated material. Graders and elevated scrapers are preferred since they can scrape a thin layer of oiled sand. Front-end loaders are less accurate, but can remove windrows made with graders. Bulldozers should be used as a last resort. Fine sand beaches are harder and provide better traction for vehicles. Traction is worse in the lower intertidal zone due to water-saturated sediments and above the normal intertidal area due to soft, wind-blown sediments. Reduced tire pressure can improve traction. Avoid excessive removal of sediment. • Manual removal is preferred for medium-heavy oils, but is less effective where oil is buried or reworked into sediments. Straight-edged shovels work better than pointed shovels. Front-end loaders can improve the efficiency of manual removal. • Flooding from a perforated pipe or a hose without a nozzle can remove light-medium oils on the surface but is ineffective if oils have penetrated below the surface. Flood oil into lined trenches or sumps and collect with skimmers or vacuum units. • Use low-pressure, cold-water washing on light-medium oils where penetration is not too deep and direct the liquid into lined trenches. Collect oil using vacuum units or skimmers. • Skimmers in boomed areas adjacent to a shoreline being cleaned can also collect washed oil. However, currents, waves, water depth, and the amount of debris may limit this approach.

Table 12-2 Treatment Options by Shore Type (continued)

Shore Type	Treatment Options
<p>Coarse-Grained Sand Beaches</p>	<ul style="list-style-type: none"> • Natural recovery may be acceptable for small spills, light-medium oils, or on exposed or remote coasts. • Mechanical removal is appropriate using graders or scrapers only if large amounts of heavy-to-solid oil can be recovered. Due to poor bearing capacity, use front-end loader with backhoe only as second choice. • Natural replacement of coarse sediment is very slow so removal of oiled material may require replacement to prevent shoreline retreat. Obtain advice from a coastal geomorphologist regarding the appropriate quantity of sediment that can be removed. • Flooding from a perforated pipe or a hose without a nozzle can remove light-medium surface oils but is ineffective if oil has penetrated into underlying sediments. Flood oil into lined trenches or sumps and collect the oil with skimmers or vacuum units. • Low-pressure, cold-water washing can be applied to light-medium oils. This removes mobile oil from surface and subsurface sediments, which is more effective than flooding. Contain oil in lined trenches and collect the oil using vacuum systems. • Avoid using warm-water washing or flooding on viscous oils. Heating can reduce oil viscosity, resulting in deeper oil penetration into the beach. • Skimmers in boomed areas adjacent to the shoreline being cleaned can also collect washed oil. However, currents, waves, water depth, and the amount of debris present may limit this approach.

Table 12-2 Treatment Options by Shore Type (continued)

Shore Type	Treatment Options
<p>Tundra Cliffs</p>	<ul style="list-style-type: none"> • Oil will most likely be naturally removed within a very short time. • Manual removal of oil or oiled tundra at the base of a cliff is only practical for a small amount of material. • Mechanical options are not advisable because they can accelerate erosion. • Natural peats are common and can be used as a sorbent, provided they do not come from the living tundra. • Vacuuming may be applicable for oil that has pooled. • Flooding can accelerate flushing of light oils from the beach sediment or from peat. • Aggressive treatments, such as high-pressure washing, hot-water washing, or burning are not appropriate.
<p>Gravel and Cobble Beaches</p>	<ul style="list-style-type: none"> • Natural recovery is preferred for small spills of light-to-medium oils on exposed or remote coasts. • Manually remove surface oiled sediments, asphalt pavement, tar patties, small oiled debris. Pointed shovels work best. • Flooding using water from a perforated pipe or a hose without a nozzle can remove light-medium oils but is ineffective on oils that have penetrated into underlying sediments. Direct oil into lined trenches or sumps and collect the oil with skimmers or vacuums. • Low-pressure, cold-water washing also can be used to direct oil into lined trenches. This is more effective in removing viscous oils from surface and subsurface sediments than flooding. • Avoid using warm-water washing or flooding on viscous oils. Heating can reduce oil viscosity resulting in deeper oil penetration into the beach. • Skimmers in boomed areas adjacent to the shoreline being cleaned can also collect washed oil. However, currents, waves, water depth, and the amount of debris present may limit this approach. • Before removing gravel or cobble, obtain advice from a coastal geomorphologist regarding the appropriate quantity of sediment that can be removed, if any. • For steep cliffs, specially-designed omni-booms are the safest means of washing off oil.

Table 12-2 Treatment Options by Shore Type (continued)

Shore Type	Treatment Options
Riprap	<ul style="list-style-type: none"> • Natural recovery is preferred for lighter oils and more exposed settings. • Manual removal of debris and small persistent oil pockets. • Early use of vacuum on pooled oil in crevices can increase the oil recovery rate. • High pressure/temperature washing may be needed to flush out viscous oils.
Exposed Tidal Flats	<ul style="list-style-type: none"> • Natural recovery is preferred for all oil types since response activities can cause more impacts than the oiling of the shore. • Mechanical removal is not an option since the poor bearing capacity of tidal flats to support personnel and machinery causes difficulties for treatment operations. Operations may be staged from a barge or flat-bottomed boat, which can ground at low tide and be refloated at high water. Care should be taken not to disturb sediment. • Vacuum systems are useful for small amounts of pooled light-to-medium oil (unsafe for gasoline). Trenches may capture oil during ebb tide. • Manually remove small amounts of pooled oil. • Flooding can be used for low-medium viscosity oil with sorbent for collection. • Low-pressure, cold-water washing can be used on light-medium oils. Contain oil in lined trenches and recover with vacuum unit or skimmer.

Table 12-2 Treatment Options by Shore Type (continued)

Shore Type	Treatment Options
<p>Exposed Vegetated Tidal Flats</p>	<ul style="list-style-type: none"> • Natural recovery is preferred for small spills of light-to-medium oils on exposed or remote coasts. • Manual removal of surface oiled sediments, asphalt pavement, tar patties, and small, oily debris is possible where the bearing capacity allows. • Flooding from a perforated pipe or a hose without a nozzle can remove light-medium oils, but is ineffective on oils that have penetrated into underlying sediments. Flood oil into lined trenches or sumps and collect it with skimmers or vacuum systems. • Methods of trapping or containing oil (trenches and ditches) for collection on a falling (ebb) tide may be effective. • Low-pressure, cold-water washing is more effective in removing viscous oils from surface and subsurface sediments than flooding. Wash oil into lined trenches. • Avoid using warm-water flooding or washing on viscous oils. Heating can reduce oil viscosity resulting in deeper oil penetration into the beach. • Manual removal with hand tools can be combined with vacuum systems and skimmers. • In situations where tidal flats do not support personnel or equipment, low-pressure, cold-water washing may be used at high tide to herd light-medium oil into boomed areas. Recover using either drum, disc, and rope mop skimmers, or sorbents for small amounts of oil. • Cutting vegetation can delay recovery, but may be advisable when migratory or nesting birds are at risk. Cutting affects plant re-growth and survival least during fall and winter. Consult ecology experts for advise.

Table 12-2 Treatment Options by Shore Type (continued)

Shore Type	Treatment Options
<p>Sheltered Rocky Shores and Clay Scarps</p>	<ul style="list-style-type: none"> • Natural recovery is preferred for light-medium oils that reach sheltered rocky shores. Stranded, light oil may be removed by wave action within weeks, although heavy oil can persist for years and may collect in hollows or burrows. Manual removal of small amounts of medium-heavy oils is usually possible. • Vacuum systems are effective for light, medium and heavy oils that collect in tidal pools and hollows (unsafe for gasoline). • Flooding from a perforated pipe or a hose without a nozzle is appropriate for light oils. Do not allow oil to flow downslope into lower intertidal zone. • Low-pressure, cold-water washing can also be useful for light-medium oils. Washing from a boat or barge eliminates impacts to organisms from foot traffic. Prevent oil flow downslope into lower intertidal zone. Contain and collect the oil using booms and skimmers or sorbents. • Low-pressure, warm/hot water washing is appropriate on more viscous oils that cannot be removed by cold water. • High-pressure, cold-water washing can be used on viscous oils that cannot be removed by low-pressure washing. • High-pressure, warm/hot water washing, steam cleaning, or sandblasting are effective and appropriate on surfaces where no organisms are present. • Chemical shoreline cleaners may be applied to small amounts of oil during flooding tide where there is sufficient circulation. Sorbents can be used to collect the freed oil. • For steep cliffs, specially-designed omni-booms are the safest means of washing off oil.

Table 12-2 Treatment Options by Shore Type (continued)

Shore Type	Treatment Options
Peat	<ul style="list-style-type: none"> • Natural recovery may be the preferred option. • Partial removal of heavily oiled peat may be beneficial. • Mechanical cleaning and aggressive removal are often not appropriate.
Inundated Lowland Tundra	<ul style="list-style-type: none"> • Natural recovery is preferred and has least impact for small to moderate spills. • Cleanup is warranted when large amounts of oil persist and act as a source of chronic re-oiling of adjacent sensitive habitats. • Sorbents, debris removal, and low-pressure flooding are the principal options to consider.
Sheltered Tidal Flats	<ul style="list-style-type: none"> • Natural recovery is preferred for all oil types since response activities can cause more impacts than shoreline oiling. • Flooding with water from a perforated pipe or a hose without a nozzle can remove light-medium oils but is ineffective if oil has penetrated to underlying sediment. Flood oil into lined trenches or sumps and collect with skimmers or vacuums. • Low-pressure, cold-water washing can be used on light-medium oils. Washing from a boat or barge eliminates impacts to organisms from foot traffic. Disc, drum and rope mop skimmers in boomed areas adjacent to the affected shoreline can collect washed oil.

Table 12-2 Treatment Options by Shore Type (continued)

Shore Type	Treatment Options
<p>Salt Marshes and Mangroves</p>	<ul style="list-style-type: none"> • The best protection is to spray with dispersants offshore before the oil can enter these habitats. • Natural recovery is generally preferred since treatment may disrupt the natural regenerative processes. But, since oil can affect the root systems of mangroves, a shoreline cleaner sprayed onto mangroves, which are covered with heavy oil, may reduce adhesion. (See Section 12.8) • Burning in salt marshes is one of the preferred treatment methods. Avoid burning when the lower stems are dry and exposed. • Intervention may be appropriate in marshes where oil has concentrated and may be widely spread with tidal action, where oil is a threat to wildlife, or when recovery may take decades (thick deposits of heavy oil). To avoid disruption of root systems by sediment removal or compaction from machinery and workers, work should be carried out from a boat. Road mats and low-pressure tires can reduce impacts when equipment must be moved on land. • In marshes and mangroves, low-pressure, cold-water washing may be used to herd light-medium surface oil into boomed areas. Recover oil using drum, disc and rope mop skimmers, or sorbents for small amounts of oil. Care should be taken to avoid excessive erosion. • Cutting oiled marsh plants can delay recovery, but may be advisable where migratory or nesting birds are at risk. Consult ecology experts for advice.

Table 12-2 Treatment Options by Shore Type (continued)

Shore Type	Treatment Options
<p>Sensitive Near-shore and Offshore Habitats</p> <p><i>Coral Reefs, Lagoons, Kelp Beds, Seagrass Beds</i></p>	<ul style="list-style-type: none"> • Dispersants can be used to protect coral reefs and associated nearshore kelp and seagrass beds when applied in waters >30 ft (10 m) or in areas with rapid natural dispersal. Their use minimizes cleanup vessel traffic. • In coral lagoons, removal of surface oil using booms and skimmers or vacuum units is advisable. • Navigating fringe coral reef areas is difficult and may preclude skimming, particularly when surface oil obscures sight of the coral. Natural recovery is preferred. • Low-pressure water streams can sometimes be used to direct oil floating above corals into booms for removal by skimmers or vacuum units. • Avoid in-situ burning and sinking agents directly above coral reefs, kelp, and seagrass beds. • Sorbents and manual removal methods should not be used on coral reefs.

12.5 Natural Recovery

Natural recovery is a treatment technique that allows a site to recover without intervention or intrusion. All shore types affected by small amounts of non-persistent oil can recover naturally, given appropriate circumstances. Assessment of the oiling (Section 12.2) and resources at risk is required to determine the likely consequences of allowing oil to weather naturally. Shorelines should be monitored to ensure that recovery occurs.

Natural recovery may be appropriate when:

- Oiling has occurred on high-energy beaches (primarily cobble, boulder and rock) where wave action will remove most of the oil in a relatively short time.
- Shorelines are remote or inaccessible.
- Treatment or cleaning of stranded oil may cause more damage than leaving the shore to recover naturally.
- Other response techniques either cannot accelerate natural recovery or are not practical.

Natural recovery may not be appropriate when:

- Important ecological resources or human activities/resources are threatened.
- Stranded oil might be remobilized and contaminate or re-oil adjacent resources or clean sections of shore.

Possible ramifications of natural recovery include:

- Sensitive areas may take considerable time to recover.
- The oil may adversely affect vegetation and organisms (smothering and/or toxicity).

12.6 Physical Treatment Techniques

Physical techniques are typically used to remove oil stranded in an intertidal zone when natural recovery is not an acceptable response strategy. In this section, a series of tables presents information on physical treatment options, including a brief description of each method, where it likely would be applied, its possible effects, and the logistical support required. Treatment rates and personnel requirements have been estimated based on the level of effort generally required to treat an area in an 8-hr day. Techniques have been arranged in approximate order of their likely environmental impact, beginning with the least intrusive:

- Four methods used by cleanup teams to manually remove oil from shores are described in Tables 12-3 through 12-6.
- Treatment techniques involving the application of water to remove oil from sediments and bedrock have been summarized in Tables 12-7 through 12-9.
- Steam cleaning and sandblasting, sometimes used to remove oil from hard surfaces, are described in Tables 12-10 and 12-11. Operators and nearby crew of such equipment need PPE, especially respiratory protection from any aerosols created during use.
- Vacuums, including truck-mounted and portable units (see also Section 11.4) used to remove oil pooled on shore, are listed in Tables 12-12 and 12-13.
- Heavy machinery, used singly and in combination when access and other circumstances allow, are detailed in Tables 12-14 through 12-23. In selected circumstances, draglines or clamshell dredges could be used to collect oiled sediment and debris.

Many types of mobile mechanical equipment use inflatable tires, whose pressure can influence the efficiency of operation. It is advisable to adjust tire pressures to suit shoreline conditions.

Table 12-3 Sorbent Application

Description	
Sorbents are applied manually to soak up non-sticky oil stranded on shore. Pom-poms are positioned in the intertidal zone as a passive array to collect viscous (sticky) oil.	
Application	
Use on all shore types to remove small accumulations of oil.	
Possible Adverse Effects	
Foot traffic may disturb sediments and affect organisms. Birds and small mammals may ingest particulate sorbents if they are left uncollected.	
Equipment	Quantity Required (per day)
Sorbent sheets	20 bales (100–200 pads/bale)
Sorbent rolls	20 rolls [36 in (90 cm) x 150 ft (45 m)/roll]
Sorbent boom	20 bales [4 ft (1.2 m) length x 8 in (20 cm) dia. x 10 ft (3 m)/bale]
Pom-poms (for viscous (sticky) oil)	10 bales (100/bale)
Pitchforks, rakes, etc.	10–20
6-mil (0.15 mm) plastic bags (white or light color)	10 cartons (40–50/carton)
Personnel	Optimum Treatment Rate
10–20 workers	Treatment rate is highly variable. Expect up to 1/4 gal (1 liter)/pad of oil recovery, depending on oil type.
1 foreman for every 10 workers	
Disposal	Suggestion
Pads and rolls	Disposal is facilitated by rolling up sorbent and placing it in suitable containers.
Boom	Disposal is accomplished by folding, rolling and/or stuffing the boom into plastic bags for removal.
Loose material	Loose sorbent materials are not recommended for use on oil on water or tidal shorelines due to difficulty in recovery for disposal.
Access	
Light motor vehicle, shallow craft or helicopter	

Table 12-4 Manual Removal of Oiled Materials

Description		
Oiled sediment and debris are removed by hand, shovels, rakes, etc.		
Application		
Use on mud, sand, gravel, and cobble when oiling is light, sporadic, and/or at or near the beach surface, or on beaches where there is no access for heavy equipment.		
Possible Adverse Effects		
May disturb/remove sediment and shallow burrowing organisms.		
Equipment	Number Required	
	Lightly Oiled Shoreline [~1.2 miles (2 km)]	Heavily Oiled Shoreline [~1.2 miles (2 km)]
Shovels, rakes, picks	10–20	50–100
Debris box or super sac	2	3–4
ATV ¹ with trailers or wheelbarrows	1–2	1–2
Personnel	Lightly Oiled Shoreline [~1.2 miles (2 km)]	Heavily Oiled Shoreline [~1.2 miles (2 km)]
Workers	10–20	50–100
Foremen	1–2	5–10
Access		
Foot path, road, shallow craft or helicopter		

¹ ATV is an All Terrain Vehicle.

Table 12-5 Manual Scraping

<p>Description Oil is manually scraped from substrate using hand tools.</p> <p>Application Use on lightly oiled boulders, rocks, and man-made structures or heavy accumulations when other techniques are not allowed or are not practical.</p> <p>Possible Adverse Effects May disturb sediment and remove or injure organisms. Unremoved or unrecovered oil can injure organisms that are repopulating the rocky substrate or inhabiting sediment downslope of cleanup activities.</p>	
Equipment	Number per Crew
Paint scrapers	1 per worker (plus several extra to allow for loss of edge or breakage)
Sharpening tool (file/hone)	1
Rakes, shovels, trowels	1 each per worker
Plastic bags	75–100
Ground cover (for initially catching removed oil) such as: <ul style="list-style-type: none"> • Plastic film • Cloth • Sorbents 	1–3 rolls
Personnel	Optimum Treatment Rate
5 crews of 10 workers each	The treatment rate is highly variable, depending on degree of oiling, type of substrate, and the number of non-oiled plants and animals to be protected.
1 foreman for each crew	
Access	
Foot path, shallow craft, or helicopter	

Table 12-6 Vegetation Cutting

<p>Description Oiled vegetation is cut by hand, collected, and put into bags or containers for disposal.</p> <p>Application Use on oiled vegetation.</p> <p>Possible Adverse Effects May disturb and remove sediment and organisms. Heavy foot traffic may cause root damage and delayed recovery. May cause erosion due to loss of vegetation.</p>	
Equipment	Number per Crew
Cutting tools such as: <ul style="list-style-type: none"> • Scythes • Power cutters • Shears 	3–4 (plus 1 or 2 extra in case of breakage or dull blades)
Sharpening tool (file/hone)	1
Collecting tools such as: <ul style="list-style-type: none"> • Pitch forks • Rakes 	4–6
Plastic bags	75–100
Ground cover such as: <ul style="list-style-type: none"> • Plastic film • Burlap • Sorbents 	1–3 rolls
Personnel	Optimum Treatment Rate
5 crews of 10 workers each	Each crew can cut and bag about 77 yd ² /hr (65 m ² /hr) of vegetation on a heavily vegetated shoreline.
1 foreman for each crew	
Access	
Foot path, shallow craft or helicopter	

Table 12-7 Low Pressure, Cold-Water Washing

<p>Description Low-pressure water spray removes oil from substrate and channels it to recovery points. [Nozzle pressure is kept below 100 psi (690 kPa)].</p> <p>Application Use to wash oil from mud, cobble, boulder, rock, man-made structures, and vegetation.</p> <p>Possible Adverse Effects May create a potential for re-oiling and disturbance of organisms downslope of cleanup if oil is not contained and removed.</p>		
Primary Equipment	Type	Number
Washing unit (pump and hoses)	10–20 psi (70–140 kPa) pressure @ 50–100 gpm (190–380 L/min)	3–5
Vacuum system	110 barrel (17.5 m ³) capacity	1–2
Pump and tank truck	50–75 gpm (190–285 L/min), 125 barrel (20 m ³) capacity	1–2
Equipment to contain and recover loosened oil, if required	Boom and skimmer	
Personnel	Optimum Treatment Rate	
1–2 workers per washing or recovery unit; PPE required	The rate of treatment depends on the degree of oiling, type of oil and substrate and is difficult to forecast. (~220 gpm [50m ³ /hr])	
1 foreman for every 10 workers; PPE required		
Access		
Road for heavy equipment, barge, or landing craft for trucks		
Light motor vehicle, shallow craft, or helicopter for washing unit		

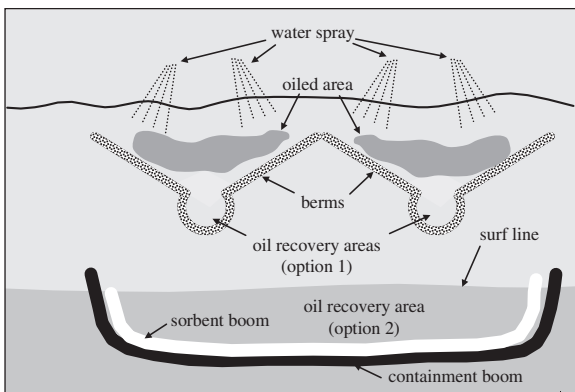

Figure 12-6 Low Pressure Flushing

Table 12-8 Low-Pressure, Warm-Water Washing/Cold-Water Flooding

<p>Description Heated seawater softens weathered oil; cold-water flooding moves the loosened oil to the adjacent water for collection. These two techniques can be used separately or together.</p> <p>Application Use on heavy concentrations of weathered, sticky oil that has reached sheltered or moderate energy shorelines composed of rock, cobble, and gravel.</p> <p>Possible Adverse Effects May injure intertidal organisms. High nozzle pressure can cause localized erosion.</p>		
Primary Equipment	Size of Unit	Quantity
Landing craft (or suitable trailers for land-based operations)	40–80 ft (12–24 m)	1
Direct-fired water heater	8 million BTU/hr (2340 kW) 125 gpm (475 L/min) @ 140°F (60°C)	2
Pumps	6 in (15 cm) @ 100 psi (690 kPa)	2
Generator	70 hp (50 kW)	1
Containment boom	inshore boom	600 ft (180 m)
Sorbent boom		300 ft (90 m)
Fire hoses/nozzles	1/2–1 in (1.25–2.5 cm)	4
Perforated flushing header, corrugated pipe	6 in (15 cm)	100 ft (30 m)
Manifold hose	6 in (15 cm)/4 in. (10 cm)	100 ft (30 m)
Snare boom/pom-poms		300 ft (90 m)
Support Equipment		
Water heater • Pump and generator • Landing craft		
Personnel	Optimum Treatment Rate	
2 crews of 10 workers each, 1 foreman for each crew; PPE required	The rate of treatment depends on the degree of oiling, type of oil and substrate, and is difficult to forecast. (~220 gpm [50m ³ /hr])	
Access		
Landing craft or road for heavy equipment, barge		

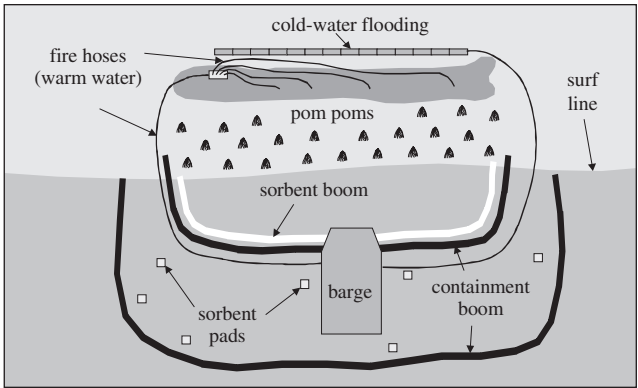

Figure 12-7 Low-Pressure, Warm-Water Washing/Cold-Water Flooding

Table 12-9 High-Pressure Washing

<p>Description High-pressure cold or warm water streams remove oil from substrate and channel it to a recovery area.</p> <p>Application Use to remove oil from boulder, rock, and man-made structures.</p> <p>Possible Adverse Effects May remove some organisms and shells from substrate. Can disturb substrate surface and wash oil into sub-surface sediments and downslope organisms.</p>		
Primary Equipment	Type	Number
Pressure washing unit	Self-contained 10 gpm (38 L/min) @ 4000 psi (27,000 kPa)	2-3
Equipment to contain and recover loosened oil, if required	Boom and skimmer	
Support Equipment	Type	Number
Vacuum system	60-80 barrel (9.5-13 m ³) capacity	1
Trash pump	25-50 gpm (95-190 L/min)	1
Tank truck	60-80 barrel (9.5-13 m ³) capacity	1
Personnel	Optimum Treatment Rate	
1-2 operators per pressure washing unit; PPE required	One unit that produces 3,000-4,000 psi (20,000-26,667 kPa) pressure can clean 7-15 ft ² (0.75-1.5 m ²) per minute.	
1-2 workers per recovery equipment; PPE required		
1 foreman for every 10 workers; PPE required		
Access		
Road or barge for heavy equipment, trucks		
Light motor vehicle path, shallow craft, or helicopter for washer only		

12

Table 12-10 Steam Cleaning

Description Steam removes oil from substrates and it is channeled to a recovery area.			
Application Use to remove oil coatings from man-made structures, boulders, and rock. Establish an exclusion zone.			
Possible Adverse Effects Removal of and mortality to some organisms are likely. Oil not recovered can affect organisms downslope of cleanup activities.			
Primary Equipment	Size of Unit	Number Required	Optimum Treatment Rate
Steam cleaner	280 psi (1930 kPa) @ 325°F (163°C)	4–6	600 ft ² /hr (55 m ² /hr)
Vacuum truck	80–100 barrel (12.7–15.9 m ³) capacity	1–2	
Skimmer	Small	1–2	
Containment boom	2–4 x length of shoreline cleaned	2	
Consumables		Fresh Water Consumption/Unit	
Steam cleaner		3.8–4.3 gpm (14–16 L/min)	
Personnel			
2 operators for each cleaning unit; PPE required			
1 foreman for every 10 workers; PPE required			
Access			
Road for heavy equipment, trucks			
Light motor vehicle path, shallow craft, or helicopter for steam cleaning units			

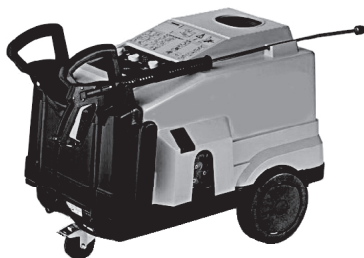

Figure 12-8 Steam Cleaner

Table 12-11 Sandblasting

Description		
Sand moving at high velocity removes oil from a substrate.		
Application		
Use to remove thin oil residue from man-made structures and other hard surfaces. Establish an exclusion zone.		
Possible Adverse Effects		
May remove organisms and shells from a substrate and leave behind a clean, barren surface. Can affect downslope organisms. Adds sand to environment, along with potential re-oiling, erosion, and deeper oil penetration.		
Primary Equipment	Number Required	Optimum Treatment Rate
Sandblasting unit (compressor included)	1	150 ft ² /hr (14 m ² /hr)
Sand supply truck	1	
Front-end loader (if used)	1	
Consumables	Amount	Optimum Treatment Rate
Sand	Approx. 1000 lb/hr (455 kg/hr)	150 ft ² /hr (14 m ² /hr)
Ground cover	1–3 rolls	
Personnel	Number Required	Optimum Treatment Rate
Workers for sandblasting	2–4; PPE required	150 ft ² /hr (14 m ² /hr)
Cleanup workers	2–3; PPE required	
Foreman	1; PPE required	
Access		
Road for heavy equipment, barge or landing craft		

12



Figure 12-9 Sand Blaster

Table 12-12 Vacuum Systems

<p>Description Truck or portable vacuum unit is positioned near oil pool or recovery site where oil is collected via vacuum hose.</p> <p>Application Use to remove oil accumulations on water in the absence of skimmers and to recover oil pooled in natural depressions on all shoreline types (except inaccessible vegetated or other areas). Unsafe for recovery of gasoline.</p> <p>Possible Adverse Effects May remove some organisms. Watch for collection of vapors.</p>			
Primary Equipment	Typical Suction Rate for Pooled Oil	Typical Suction Rate for Oil on Water	Typical Fill Time for 110-bbl (17.5 m ³) Tank
Vacuum unit ¹ with 2–3 in (5–7.5 cm) suction hose and skimming head	50–100 gpm (190–380 L/min) (75% oil)	25–50 gpm (95–190 L/min) (5% oil)	0.75 hr @ 100 gpm (380 L/min) 1.5 hr @ 50 gpm (190 L/min) 3 hrs @ 25 gpm (90 L/min)
Range of Capacities			
Vacuum system	6–140 barrels (0.9 m ³ –22.3 m ³)		
6 in (15 cm) suction hose	700–900 gpm (2650–3400 L/min) maximum ²		
4 in (10 cm) suction hose	500–600 gpm (1900–2270 L/min) maximum ²		
3 in (7.5 cm) suction hose	50–400 gpm (190–1510 L/min) maximum ²		
2 in (5 cm) suction hose	50–200 gpm (190–760 L/min) maximum ²		
Support Equipment			
Devices for herding oil on water can include:			
<ul style="list-style-type: none"> • Boom • Skimming boards 		<ul style="list-style-type: none"> • Low-pressure water hoses • Leaf blowers/air movers 	
Personnel			
1 worker per suction hose			
1–2 workers for containing, herding and manual skimming of oil			
1 foreman for every 10 workers			
Access			
Road for heavy equipment, barge or landing craft			

¹ Number of vacuum units required is dependent on the quantity of oil, the number of recovery sites, and the oil-to-water ratio.

² Intake is completely submerged, drawing fluid with little or no suction lift.

Table 12-13 Sump Pump/Vacuum System

<p>Description Oil flows into and collects in a sump where it is removed by pump or vacuum unit.</p> <p>Application Use on firm sand or mud beaches that are being continuously oiled.</p> <p>Possible Adverse Effects May cause removal of organisms due to excavation of 2–4 ft (0.6–1.2 m) sump. Watch for collection of vapors.</p>			
Primary Equipment	Typical Suction Rate for Thick Oil [0.08 in (2 mm)]	Typical Suction Rate for Thin Oil [0.04 in (1 mm)]	Typical Fill Time for 110-bbl (17.5 m ³) Tank
Vacuum unit ¹ or high capacity pump typically with 2–3 in (5–7.5 cm) suction hose and skimming head	75 gpm (285 L/min) 50 gpm (190 L/min) (50% oil)	50 gpm (190 L/min) 25 gpm (95 L/min) (5% oil)	1 hr @ 75 gpm (285 L/min) 1.5 hr @ 50 gpm (190 L/min)
Range of Capacities			
Vacuum unit	6–140 barrels (0.9 m ³ –22.3 m ³)		
Tank truck	20–160 barrels (3.2 m ³ –25.4 m ³)		
6 in (15 cm) suction hose	700–900 gpm (2650–3400 L/min) maximum ²		
4 in (10 cm) suction hose	500–600 gpm (1900–2270 L/min) maximum ²		
3 in (7.5 cm) suction hose	50–400 gpm (190–1510 L/min) maximum ²		
2 in (5 cm) suction hose	50–200 gpm (190–760 L/min) maximum ²		
Personnel			
1 worker per suction hose			
1–2 workers for containing, herding and manual skimming of oil			
1 foreman for every 10 workers			
Access			
Road for heavy equipment, barge or landing craft			

¹ Number of vacuum units or pumps required is dependent on the quantity and collection rate of oil in the sump.

² Intake is completely submerged, drawing water with little or no suction lift.

Table 12-14 Beach Cleaner

Description Pulled by tractor or self-propelled across a beach picking up tar balls or patties.		
Application Use on lightly oiled (tar balls or patties) sand or gravel beaches.		
Possible Adverse Effects May disturb upper sediments and shallow-burrowing organisms.		
Primary Equipment	Number	Optimum Treatment Rate
Operated at 4 mph (6.4 km/hr)	1	25 min/acre (1 hr/hectare)
taking a skim cut 6 ft (1.8 m) wide		
Operated at 1 mph (1.6 km/hr) taking a deep cut 6 ft (1.8 m) wide	1	1.4 hr/acre (3.5 hr/hectare)
Support Equipment		
Tractor (rubber-tired)		
Personnel		
1 operator for each piece of equipment		
Access		
Road for heavy equipment, barge, or landing craft		

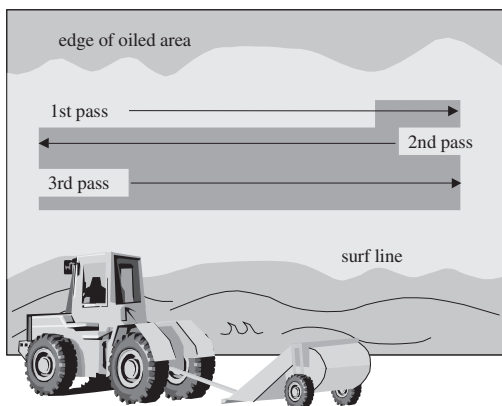

Figure 12-10 Beach Cleaner Treatment Pattern

Table 12-15 Heavily Oiled Sediment Mixing-Tractor/Ripper

Description		
Tractor fitted with either a ripper or tines is operated up and down beach (so sediments remain and erosion is minimized) to promote evaporation and weathering by shoreline processes.		
Application		
Use on heavy surface oiling (“pavement”) on cobble, gravel, and sand beaches. Use on low amenity beaches. Use where substrate removal would cause erosion.		
Possible Adverse Effects		
May disturb sediments and both shallow- and deep-burrowing organisms.		
Primary Equipment	Number Required	
	66 ft (20 m) x 1.2 mi (2 km) Area	165 ft (50 m) x 1.2 mi (2 km) Area
Tractor/ripper	1	2
Personnel	Optimum Treatment Rate	
1 operator for each piece of equipment	Machine operating at 1.5 mph (2.4 km/hr) can rip a 10 ft (3 m) swath at 1.8 acres/hr (7280 m ² /hr). About 1.2 mi (2 km) of beach can be cleaned per day.	
Access		
Road for heavy equipment, barge or landing craft		

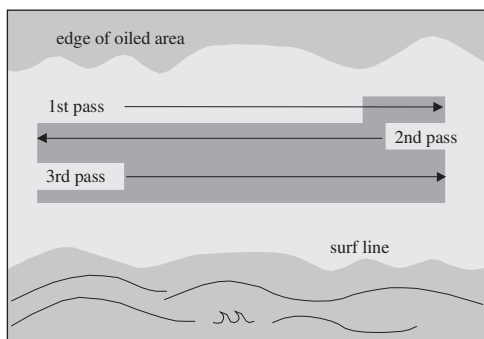

Figure 12-11 Tractor/Ripper Treatment Pattern

Table 12-16 Lightly Oiled Sediment Mixing-Discer

<p>Description Tractor pulls discing equipment along an oiled area to promote evaporation and weathering by shoreline processes.</p> <p>Application Use on lightly oiled, non-recreational sand and gravel beaches.</p> <p>Possible Adverse Effects May disturb surface substrate and shallow-burrowing organisms.</p>		
Primary Equipment	Number Required	Optimum Treatment Rate
Tractor (track-type preferred, Rubber-tired 2nd choice) and:	1	
8 ft (2.4 m) wide discer	1	0.3–0.4 hr/acre (0.75–1 hr/hectare)
12 ft. (3.6 m) wide discer	1	0.2–0.3 hr/acre (0.5–.75 hr/hectare)
Personnel		
1 operator for each piece of equipment		
Access		
Road for heavy equipment, barge or landing craft		

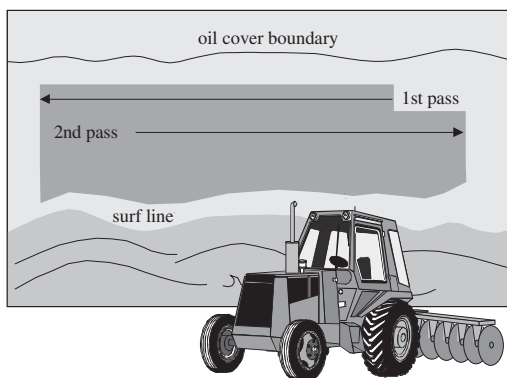

Figure 12-12 Discer Treatment Pattern

Table 12-17 Surf Washing–Bulldozer

Description			
Mechanical equipment pushes oiled substrate into the surf zone to accelerate natural cleaning while causing minimal erosion.			
Application			
Use on level gravel and cobble beaches or firm sand where erosion of beach or backshore area is a concern.			
Possible Adverse Effects			
Leaves oil in the intertidal zone (re-oiling is possible) and may disrupt the top layer of substrate. Because of a less accurate depth of cut and pushing of sediments, considerable mixing of sediments is likely.			
Primary Equipment	Number Required		Optimum Treatment Rate
	66 ft (20 m) wide oiled zone	165 ft (50 m) wide oiled zone	
Bulldozer	2	5	264 ft (80 m) shoreline/hr
Personnel		Optimum Treatment Rate	
1 operator for each piece of equipment		Each bulldozer covers about 5 hr/acre (12.5 hr/hectare)	
Access			
Road for heavy equipment, barge, or landing craft			

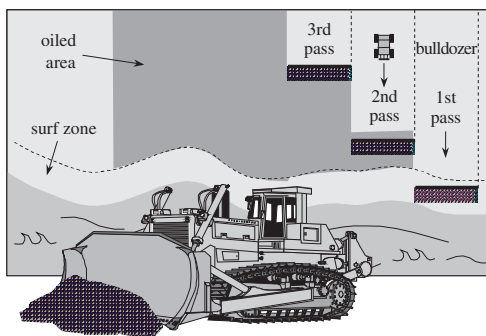

Figure 12-13 Bulldozer Treatment Pattern

Table 12-18 Mechanical Surface Cleaner–Elevating Scraper

Description Elevating scraper collects oiled material directly off a beach.			
Application Use to remove surface oil, tar balls, and patties on sand and gravel beaches.			
Possible Adverse Effects May cause disturbance of upper sediments (<1 in/2.5 cm) and shallow- and deep-burrowing organisms. Minor reduction of beach stability may lead to erosion and beach retreat.			
Primary Equipment (elevating scraper)	Number Required		Optimum Treatment Rate
	500 ft (150 m) Haul Distance	2,000 ft (600 m) Haul Distance	
20 yd ³ (15 m ³) Holding capacity	2	4	1.2–1.4 hr/acre (3–3.5 hr/hectare)
10 yd ³ (7.5 m ³) Holding capacity	4	8	
Estimated Maximum Hourly Waste Generation			
Approx. 100 yd ³ (76 m ³) with a 6 in (15 cm) cut			
Personnel			
1 operator for each piece of equipment			
Access			
Road for heavy equipment, barge or landing craft			

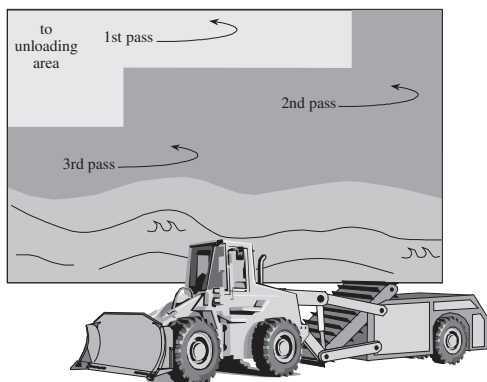

Figure 12-14 Elevating Scraper Treatment Pattern

Table 12-19 Mechanical Sediment Removal — Motor Grader/Elevating Scraper Combination

Description			
Motor grader forms windrows for collection by an elevating scraper.			
Application			
Use to remove surface oil on hard-packed sand with good trafficability.			
Possible Adverse Effects			
May cause disturbance of upper beach sediments (up to 6 in (15 cm) or greater) and shallow-burrowing organisms. May remove clean material.			
Primary Equipment	Number Required		Optimum Treatment Rate
	500 ft (150 m) Haul Distance	2,000 ft (600 m) Haul Distance	
Motor grader and:	1	1	—
Elevating scraper: 20 yd ³ (15 m ³) Holding capacity	2	4	1.2–1.4 hr/acre (3 to 3.5 hr/hectare)
10 yd ³ (7.5 m ³) Holding capacity	4	8	
Estimated Maximum Hourly Waste Generation			
Approx. 620 yd ³ (475 m ³) with a 6 in (15 cm) cut			
Personnel			
1 operator for each piece of equipment			
Access			
Road for heavy equipment, barge or landing craft			

Note: Spillage from graders can increase when multiple passes are made to side-cast oiled sediments.

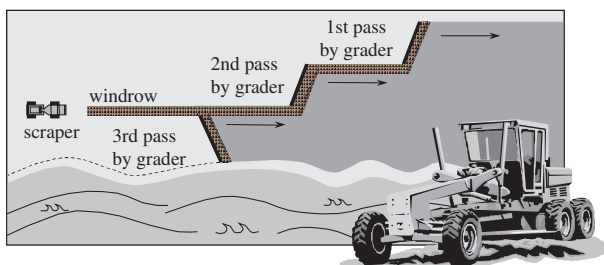

Figure 12-15 Motor Grader/Elevating Scraper Combination Treatment Pattern

Table 12-20 Mechanical Sediment Removal—Front-End Loader

Description			
Front-end loader collects material directly off a beach and hauls it to an unloading area. 1 st choice: rubber-tired loaders, 2 nd choice: track-type loaders			
Application			
Use on light-to-moderately oiled firm mud, firm sand, gravel, and (especially) cobble beaches where oil penetration exceeds 1 in (2.5 cm) and on extensively oiled vegetation. Depth of cut is ~ 6 in (15 cm).			
Possible Adverse Effects			
May remove sediment and shallow- and deep-burrowing organisms. Reduction of beach stability may lead to beach erosion and retreat.			
Primary Equipment	Number Required		Optimum Treatment Rate [3 yd ³ (2.2 m ³) bucket 2/3 full]
	100 ft (30 m) Haul Distance	500 ft (150 m) Haul Distance	
Front-end loader (rubber-tired: preferred)	2	4	3.2–3.4 hr/acre (8–8.5 hr/hectare)
Front-end loader (track-type: 2 nd choice)	2	6	4.4–4.6 hr/acre (11–11.5 hr/hectare)
Support Equipment	Optimum Number of Truck Loads/Hr		Optimum Treatment Rate
	10 yd ³ (7.5 m ³)	20 yd ³ (15 m ³)	
Dump trucks	20	10	3.6 hr/acre (9 hr/hectare) and 850 yd ³ /acre (1521 m ³ /hectare)
Estimated Maximum Hourly Waste Generation			
Approx. 180–240 yd ³ (140–180 m ³) with a 6 in (15 cm) cut			
Personnel			
1 operator for each piece of equipment			
Access			
Road for heavy equipment, barge or landing craft			

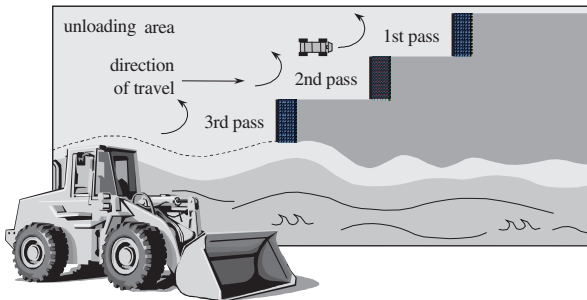

Figure 12-16 Front-End Loader Treatment Pattern

Table 12-21 Mechanical Sediment Removal—Motor Grader/Front-End Loader Combination

Description			
Motor grader forms windrows for pickup by a front-end loader.			
Application			
Use to remove surface oil from hard-packed sand beaches.			
Possible Adverse Effects			
May remove shallow-burrowing organisms. May remove clean material up to 6 in (15 cm) or greater.			
Primary Equipment	Number Required		Optimum Treatment Rate [3 yd ³ (2.2 m ³) bucket 2/3 full]
	500 ft (150 m) Haul Distance	2000 ft (600 m) Haul Distance	
Motor grader and:	1	1	—
Front-end loader (rubber-tired)	2	4	1.3–1.5 hr/acre (3.25–3.75 hr/hectare)
Front-end loader (track-type)	4	6	1.6–1.8 hr/acre (4–4.5 hr/hectare)
Support Equipment	Optimum Number of Truck Loads/Hr		Optimum Treatment Rate
	10 yd ³ (7.5 m ³)	20 yd ³ (15 m ³)	
Dump trucks	20	10	1.6–1.8 hr/acre (4–4.5 hr/hectare) 304 yd ³ /acre (575 m ³ /hectare)
Estimated Maximum Hourly Waste Generation			
Approx. 500 yd ³ (400 m ³) with a 6 in (15 cm) cut			
Personnel			
1 operator for each piece of equipment			
Access			
Road for heavy equipment, barge or landing craft			

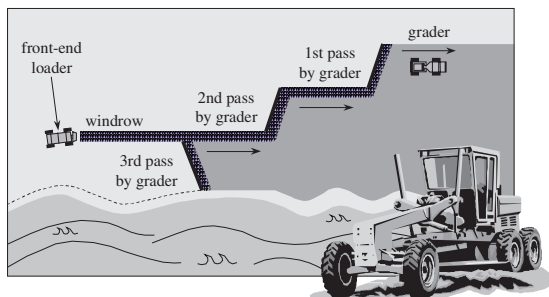

Figure 12-17 Motor Grader/Front-End Loader Combination Treatment Pattern

Table 12-22 Mechanical Sediment Removal–Bulldozer/Front-End Loader
(Rubber-Tired) Combination

Description			
Bulldozer pushes oiled substrate into piles for pickup by front-end loader.			
Application			
Use on level, heavily oiled coarse sand, gravel, and cobble beaches with poor trafficability.			
Possible Adverse Effects			
Removes 6–20 in (15–50 cm) of beach and organisms. May lead to erosion and cliff or beach retreat and inundation of backshores in extreme circumstances.			
Primary Equipment	Number Required		Optimum Treatment Rate [3 yd ³ (2.2 m ³) bucket 2/3 full]
	100 ft (30 m) Haul Distance	500 ft (150 m) Haul Distance	
Bulldozer and:	1	1	—
Front-end loader (rubber-tired)	2	4	~5 hr/acre (12.5 hr/hectare)
Front-end loader (track-type)	2	6	~4.5 hr/acre (11.2 hr/hectare)
Support Equipment	Optimum Number of Truck Loads/Hr		Optimum Treatment Rate
	10 yd ³ (7.5 m ³)	20 yd ³ (15 m ³)	
Dump trucks	20	10	5.3 hr/acre (13 hr/hectare) and 1207 yd ³ /acre (2281 m ³ /hectare)
Estimated Maximum Hourly Waste Generation			
Approx. 160–180 yd ³ (120–140 m ³) with a 6 in (15 cm) cut			
Personnel			
1 operator for each piece of equipment			
Access			
Road for heavy equipment, barge or landing craft			

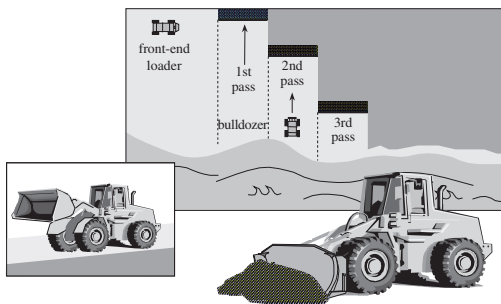

Figure 12-18 Bulldozer/Front-End Loader Combination Treatment Pattern

Table 12-23 Mechanical Sediment Removal—Backhoe

Description			
Operates from top of a bank or beach and from a shore to remove oiled sediments and loads them into a truck.			
Application			
Use to remove oiled material, including logs and debris.			
Possible Adverse Effects			
Removes 6 – 20 in (15 – 50 cm) of beach and organisms. May lead to reduction of beach stability and beach retreat.			
Primary Equipment	Number Required		Optimum Treatment Rate
	0.45 yd ³ (0.3 m ³) Bucket	0.6 yd ³ (0.4 m ³) Bucket	
Backhoe	4	3	6.4–6.8 hr/acre (16–17 hr/hectare)
Support Equipment	Optimum Number of Truck Loads/Hr		Optimum Treatment Rate
	10 yd ³ (7.5 m ³)	20 yd ³ (15 m ³)	
Dump trucks	20	10	6.8 hr/acre (17 hr/hectare), 1 ft cut depth
Estimated Maximum Hourly Waste Generation			
Approx. 120 yd ³ (90 m ³) with a 6 in (15 cm) cut			
Personnel			
1 operator for each piece of equipment			
Access			
Road for heavy equipment, barge or landing craft			

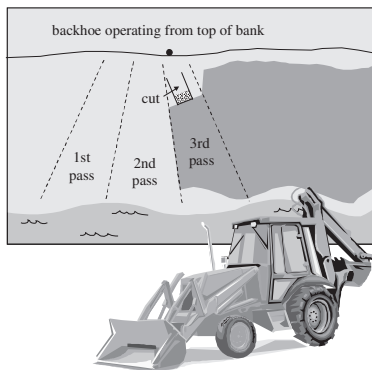

Figure 12-19 Backhoe with Front Bucket Treatment Pattern

Biodegradation is the microbial conversion of hydrocarbons in oil to carbon dioxide and water. It typically occurs at an oil-water interface and may be limited by the availability of oxygen, moisture, and nutrients, particularly nitrogen and phosphorus. Biodegradation rate is a function of temperature.

Bioremediation is acceleration of the microbial conversion of hydrocarbons in oil to carbon dioxide and water. This typically occurs through application of nutrients where organisms are metabolically limited. On many shorelines, the limiting nutrients will be nitrogen and phosphorus, which can be applied in the form of fertilizer.

- In temperate climates, bioremediation generally works best during summer months, provided sufficient moisture is present.
- Low ambient temperatures do not necessarily exclude bioremediation. Activity has been recorded at temperatures below freezing, and biodegradation does occur in arctic areas during summer.
- In most cases, other forms of treatment may be required prior to nutrient addition to achieve the desired enhancement rate.

Most areas of the world have indigenous bacteria capable of degrading oil.

- The use of products containing non-native bacteria and enzymes is currently not recommended because they are generally not required and may be detrimental.
- The decision to use bioremediation should be based on the nature of an oil, the character of an affected shoreline, and the relevant political jurisdiction.

Bioremediation is typically used as a final treatment step after completing conventional shoreline treatment or in locations where other forms of treatment are either not possible or not recommended. In cases where surface oiling is either moderate or high, water or chemical washing of a shoreline is recommended as a first step to remove bulk oil. For light surface oiling and subsurface oil, bioremediation may be considered without pre-treatment. Any pooled oil, mousse, or tar balls should be manually or mechanically removed before attempting bioremediation.

The challenge for bioremediation is to supply nutrients in such a way that they are not applied in excessive amounts and are not washed away by tides, beach runoff, or any water supplied by mechanical sprinkler systems. For similar reasons, application of nutrients to spills on open water is not recommended.

Data collected to date indicate that when application guidelines are followed, the environmental risks associated with bioremediation are negligible.

- Toxicity concerns to biota in the water column and on the shoreline are primarily related to ammonia concentration.

- Ammonia is not a problem when nutrients are properly applied.
- Concerns about algae blooms due to increased nutrient levels need to be addressed, especially for beaches with relatively poor natural flushing.

Fertilizer application does not preclude future physical treatment techniques, but it will be most effective after physical techniques have been conducted.

- Applying fertilizer at the same time that any tilling or berm relocation is done would be particularly effective.
- Experience has shown that fertilizer applications are most effective when applied some time after the initial oiling, probably at least 14 days after oil has become incorporated into beach material.
- There is time to get fertilizers to the spill site after the spill has occurred. Therefore, it is unnecessary to stockpile fertilizers as part of contingency planning.

Application rates. For a liquid fertilizer, for example containing 7–8% nitrogen and 3% phosphorus, a suitable application rate of 0.75 gal/100ft² (300 g/m²) may be used. When using solid, time-release fertilizers use a suitable application rate for example of 4 lb/100 ft² (200 g/m²). These fertilizers typically contain 25-30% nitrogen and 3-4% phosphorous. Reapplicaton may be warranted.

12.8 Chemical Treatment Methods

Chemical treatment products can increase the efficiency of water-washing oiled shorelines, seawalls, and docks. These products include treatment chemicals, such as COREXIT EC9580. For use on shorelines, such products must be listed on government-approved product schedules in some countries.

An important consideration in selecting a chemical treatment product is whether the authorities require that the oil be recovered or allow it to be dispersed into the sea.

- When recovery of the washed oil is required, a shoreline treatment product may be applied as a pre-soak at a rate of 0.5 to 1 gallon per 100 ft² (2–4 liters per 10 m²) 10 to 15 minutes before water washing.
- No chemical cleansing product is normally needed in the wash water.
- Boom is used to contain the oily washings in the area immediately offshore.
- Washing should be done during an incoming tide.
- Skimmers and/or sorbents are used to recover the released oil from the surface of the water.
- For spot washing applications, sorbents (in the form of pads, snares, or booms) can be placed around the base of the rock surfaces to be cleaned in order to recover oil from the wash water.

In the US, the Environmental Protection Agency maintains a list of products that may potentially be used in the event of an oil spill response. Other countries may maintain similar lists.

12.9 Inland Spills

Inland spills present a variety of challenges in regard to soil composition, vegetation, geology, bodies of water and water tables, and access to spill site in some cases. The proximity of human populations, land use, and potable water sources should be considered in developing response strategies. Depending on the season, inland spills may have a high potential for wildlife exposure. For spills on or near roadways, traffic control and safety may be the dominant factors in response decision-making.

A spill on land can occur to the surface (e.g., tanker truck rollover, train derailment) or subsurface (e.g., pipeline, underground storage tank). It may be difficult to model the trajectory or path of oil due to natural contours of the land, vegetation, and manmade structures. Oil on land is greatly influenced by the sorptive capacity of land surfaces, will flow down slope to lower lying areas, and can flow to surface waters or ground waters. A spill to flowing freshwater has a greater potential for transporting a slick than a spill to a quiescent lake or pond.

12.9.1 Cleanup Strategies

As with spills on water, cleanup operations on land should begin as soon as possible. Response options include mechanical recovery, in-situ burning, manual collection, and bioremediation. Unlike response on water, where the spreading of oil is unabated except for the use of containment boom, other barrier, or when oil strands on a shoreline, containing a spill on land can be done by berms, dams, sorbents or trenches.

Response strategies should consider the type of land oil is spilled on, the season, and the type of oil, which will influence the slick transport, its weathering, and potential effects (e.g., including adhesion, penetration, degradation, and toxicity). For example,

- Gasoline does not adhere well to vegetation in comparison to heavy crude, and it will degrade and evaporate much faster.
- Frozen ground in winter will be impermeable to spilled oil.

Natural depressions will cause pooling of surface oil that can be collected using skimmers and vacuum systems. The use of heavy machinery, such as bulldozers and front-end loaders should be considered in view of potential damage to some substrates (see Section 12 treatment guides). For altered terrains and in developed areas, their use may be preferred. For spills on or near roadways, vapor suppression

and firefighting may be the preferred initial response strategy. Use of in-situ burning should consider proximity to populated areas due to estimated particulates in the smoke plume and its forecast trajectory.

12.10 Material Take Off (MTO) List

A wide variety of equipment is used to conduct shoreline treatment.

Equipment	Use
Graders/draglines	Shoreline treatment
Tractor/rippers	Shoreline treatment
Front-end loaders	Shoreline treatment
Beach cleaners	Shoreline treatment
Discers	Shoreline treatment
Backhoes	Shoreline treatment
Bulldozers	Shoreline treatment
Elevating scrapers	Shoreline treatment
Flatbed, dump trucks	Removal of oiled material
Vacuum trucks	Removal of pooled liquid
Garbage cans and bags	Removal of oiled material
Portable tanks	Storage of recovered materials
Sorbents	Recovery of pooled liquid
Booms and skimmers	Containment and removal of oil
Hand tools	Vegetation cutting, equipment repair
Shovels/rakes/pitchforks	Removal of oiled material
Protective clothing	Personal protection
Pumps/hoses	Transfer of collected oil
High-pressure washers	Low- and high-pressure washing
Steam cleaners	High-pressure washing
Sandblasting equipment	High-pressure washing
Fuel	Fueling equipment
Chemicals	Removal of oil coating on hard surfaces
Fertilizer	Biodegradation of oil

13 Oiled Wildlife Response

13.1 Introduction

This section is intended as an overview and to provide general guidance when dealing with wildlife in conjunction with oil spill response activities. New technology and methods have increased the success rate for oiled wildlife response. Research continues to improve the successes of oiled wildlife response. The basic sequence of steps in oiled wildlife response is:

- Hazing
- Capture and transport
- Processing captured animals
- Health assessment / triage
- Stabilization and cleaning
- Conditioning and release
- Necropsy and disposal

Success of a rescue program will depend on the level of cooperation with government agencies and wildlife rehabilitators. Capture of and care for oiled wildlife can be a hazardous activity and a rescue program will be successful only if people are not injured or placed at unreasonable risk. In addition to the health and safety information in Section 2, there are special considerations due to the potential for injury and infection from the capture and caring of wildlife.

Oiled wildlife response is logistics-intensive and requires significant planning for trained personnel, equipment, and facilities. The sooner oiled wildlife are captured and rehabilitated, the better their chance of survival. Although many animal species can be exposed by oil spills, birds are the most likely to be affected by oil spills as they may fly into an oiled area, on land or on water. Therefore, birds are used as wildlife examples in the process flow depicted in Figure 13-1 and in the Decision Trees provided in Figures 13-4 and 13-5.

13.2 Key Considerations

Important considerations in any wildlife response are to:

- Ensure the safety of the workforce
- Coordinate with the proper agencies and experienced rehabilitation organizations.

Following a significant oil spill, federal and state/provincial/territorial wildlife agencies and wildlife rescue centers should be contacted. These professionals are knowledgeable about vulnerable wildlife, including threatened or endangered species, and regulatory requirements including applicable wildlife permits. Additionally, it is often the case that an oiled wildlife hotline phone number will be provided for the public and regulatory authorities to report the locations of oiled animals.

13.3 Safety Guidelines

Wildlife rescue/rehabilitation workers can minimize risks associated with physical and chemical hazards by following the precautions below:

- Observe all safety precautions stated in the Health and Safety Plan. *Consult with site safety personnel as field conditions can change.*
- Wildlife capture and handling should be done by experienced personnel who are trained in oiled wildlife rescue and rehabilitation.
- Ensure wildlife rescue/rehabilitation workers are trained to deal with the hazards of work tasks and the proper use and limitations of personal protective equipment.
- Never conduct rescue/rehabilitation work alone; always work in teams.
- Wear approved personal protective equipment (goggles, gloves, non-skid boots or shoes, etc.).
- Maintain situation awareness in the field regarding hazardous conditions (e.g. weather, waves, tides, slippery terrain, venomous snakes, etc.)
- Keep animals below waist level to protect face and eyes from pokes, bites, and scratches. Animal bites or scratches have the potential to transmit diseases to the handler.
- Remove protective equipment and wash hands and face with soap and water or approved cleaners before eating, drinking, or smoking.
- Never eat, drink, or smoke in animal handling areas.
- Report all injuries or illnesses.

13.4 Wildlife Protection

Wildlife exposure to oil can occur through multiple routes. Exposure can occur from direct contact, through inhalation of volatile components of oil, through ingestion of oil-contaminated food or water, or through ingestion of oil as an animal cleans its oiled feathers, fur, or skin. The most effective method for protecting wildlife is to minimize potential exposure to surface oil. Therefore, the primary response strategy for wildlife protection emphasizes controlling the release and spread of spilled oil at a source. The use of dispersants, in-situ burning, protective booms, and mechanical recovery operations will help reduce the amount of oil that could potentially affect wildlife.

Wildlife species and habitats at risk should be rapidly identified and prioritized for protection. Oil-contaminated food sources including carcasses should be removed from the field.

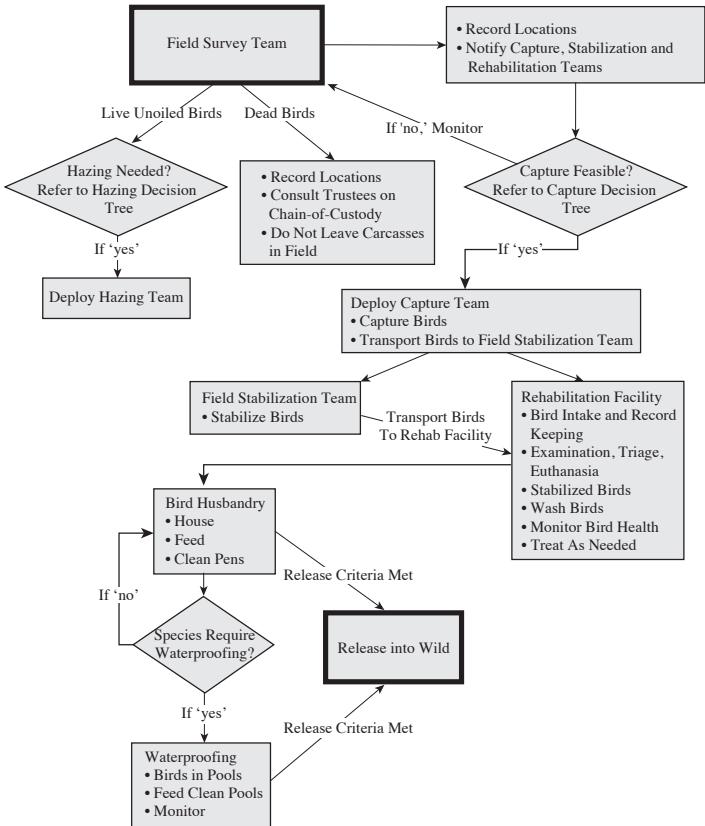

Figure 13-1 Bird rescue and rehabilitation process

13.5 Deterrence (Hazing)

Wildlife deterrent techniques can be used to move wildlife from locations that are in the predicted pathway of spilled oil. Hazing techniques can be used to deter wildlife from entering into areas that have been previously oiled. Hazing should be carefully planned and executed. It should be done in full cooperation with regulatory agencies responsible for wildlife, especially when dealing with threatened or endangered species. Figure 13-4 provides a decision tree to help determine whether hazing operations should occur. Hazing techniques include:

- Noise deterrents, including pyrotechnics, shotgun or pistol-launched projectiles, air horns, motorized equipment, propane cannons (Figure 13-2), and recorded bird alarm sounds.
- Scare devices, including deployment of reflective tape, helium-filled balloons (Figure 13-3), and scarecrows (either human or predator effigies) on oiled beaches.
- Herding wildlife using aircraft, boats, or other vehicles.
- Hazing by human presence.

Deterrent operations should consider the potential effects of human activity and disturbance on sensitive habitats and species. Disturbance of nesting, rookery, or haulout sites should be avoided as much as possible.



Figure 13-2 Noise deterrent - propane cannon



Figure 13-3 Visual deterrent - scare balloon

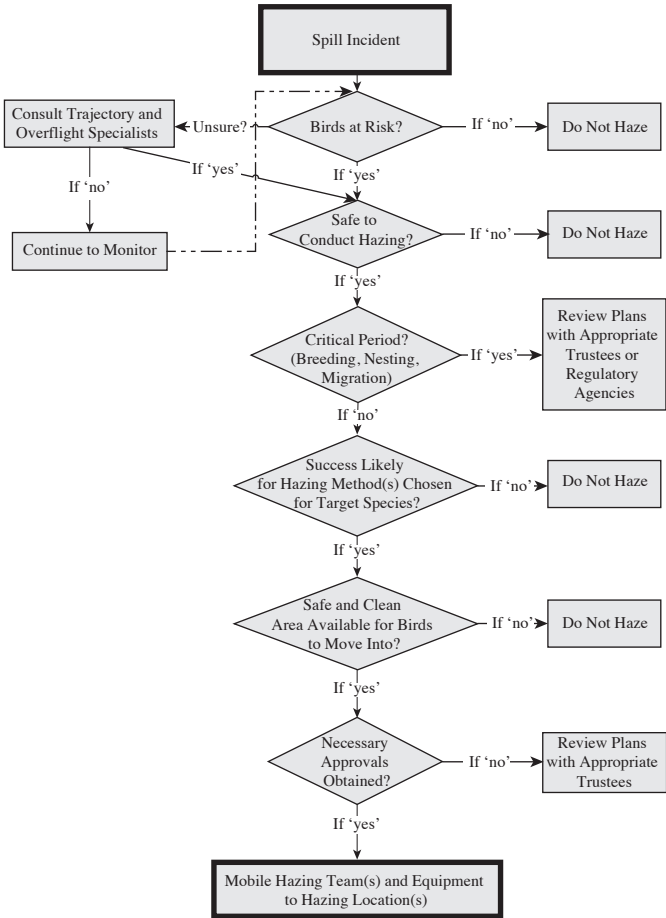

Figure 13-4 Hazing Decision Tree

13.6 Oiled Birds

Effects of oil on birds are separated into physical and toxicological effects. An example of a physical effect is oil coating and penetrating into feathers. When feathers become oiled, their water repellent and insulating properties are compromised. The loss of insulation can lead to hypothermia and possible death of an exposed animal. Toxicological effects of oil exposure can include irritation and damage to eyes, skin, and digestive tract. Many petroleum products are toxic to eggs. Spills occurring during nesting season are a concern, since adults with oiled feathers can contaminate nests, eggs, and young. During the breeding and nesting season, nesting areas should be given priority for protection. During response and clean-up operations, take care to minimize disturbance to nesting birds.

The following guidelines should be considered:

- Capturing birds is hazardous and should only be done by trained wildlife specialists.
- Once captured, birds should be handled and treated only by appropriately trained wildlife specialists.
- Threatened birds, especially large water birds (e.g., herons, loons, and cormorants) may strike at face and hands and cause serious injury.
- Boat-based capture efforts are usually less successful than land-based efforts, since oiled birds can easily elude wildlife specialists in boats.
- Wildlife specialists should wear protective clothing including glasses, gloves, and non-skid waterproof boots.
- Birds are best caught with either a long-handled fishing net or by throwing a towel, sheet, or throw net over them.
- Beached birds should be approached from the water to avoid driving them back into the water.
- To avoid injury to a wildlife specialist's eyes and face, captured birds should be held below waist level.
- Captured birds should be handled with extreme care and kept individually in warm, dry, quiet areas until release or transfer to trained caretakers.

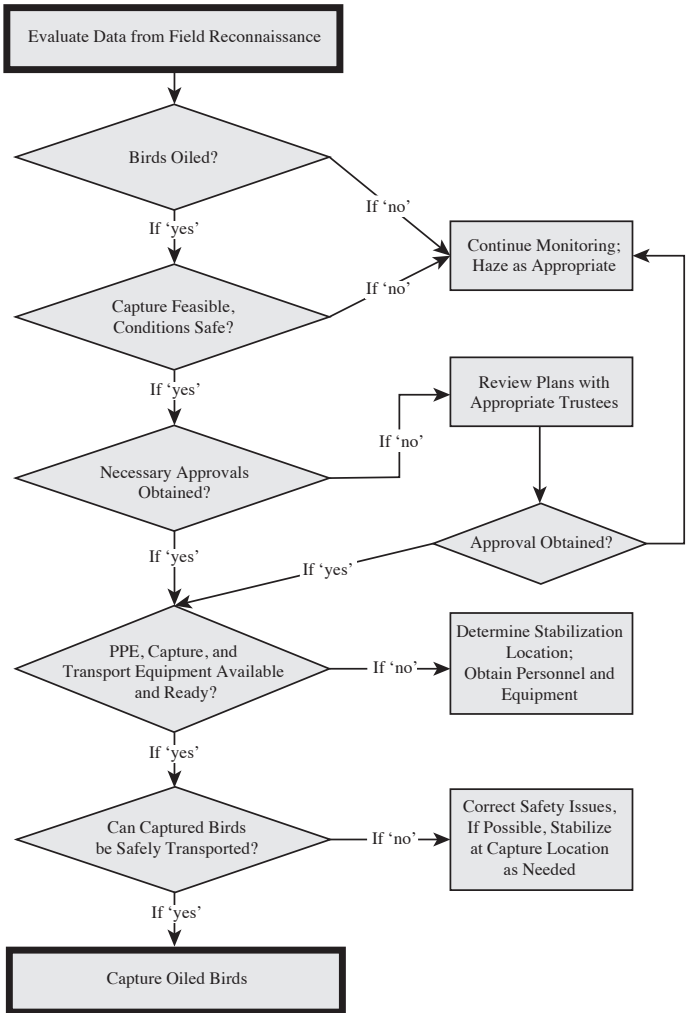

Figure 13-5 Decision Tree for Oiled Bird Capture

13.7 Oiled Mammals

Some groups of mammals are more vulnerable to oil spills than others. One observed effect of oil on some animals is their loss of body temperature control (thermoregulation). No thermoregulatory effect is expected for whales, dolphins, and manatees, which rely on blubber for insulation. However, sea otters and some seal species that depend on fur for insulation can be at risk of hypothermia. Oiling can disrupt the insulating properties of their fur and can be especially hazardous to young seals at pupping areas. Often, mammals that forage in intertidal areas (such as bear, deer, skunk, raccoon, and fox) can become exposed to oil. Contact with oil can cause skin or eye irritation. Regardless of habitat, oiled animals may try to clean themselves and can ingest oil. Depending on the amount of oil ingested, effects can occur to internal organs, the immune system, and reproduction. During spill response and clean-up operations, take care to minimize disturbances near seal rookeries or haul-out areas. Pup mortality can occur if pups are abandoned. If adults are disturbed and stampede, severe injury and mortality can occur to pups. Additionally, some mammals have inherent hazards of their own (claws, teeth) and can also be carriers of diseases such as rabies.

13.8 Oiled Reptiles and Amphibians

Oil exposure can cause both physical and/or toxicological effects. Physical effects include those from tarry residues causing blockage of nostrils, mouth, and gastrointestinal tract. Toxicological effects include skin and eye irritation, damage to internal organs, or mortality. Oil exposure can be toxic to eggs and could cause reduced hatching success and developmental abnormalities.

Sea turtles are endangered or threatened in many parts of the world. Therefore, sea turtle nesting beaches should be given priority for spill protection efforts. During spill response and clean-up operations, take care to minimize impacts to nesting beaches. Turtle eggs may need to be relocated to prevent oil contamination. Consult with regulatory authorities as to the best plan of action. Past spill events demonstrate that oiled turtles, snakes, and toads can be successfully rehabilitated and released.

Capturing turtles can be done using floating turtle traps which will reduce animal stress induced by chasing the animals (Figure 13-6). Venomous snakes may be encountered within the response zone and must only be handled by experienced wildlife handlers. Using reptile tongs and snake chaps will mitigate the risk of being bitten (Figure 13-7).

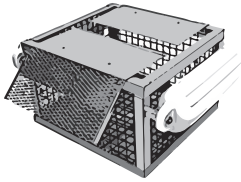

Figure 13-6 Floating turtle trap



Figure 13-7 Reptile tongs

13.9 Wildlife Treatment

Policies regarding capture, cleaning, and caring of wildlife vary in different countries. Within the United States, state and federal permits may be required depending on the animal types that are being captured. Consult with officials and prepare a wildlife management plan.

The capturing, cleaning, and caring for wildlife requires specialized procedures and wildlife professionals should be used to support a rescue and rehabilitation program and to direct less experienced workers.

Refer to the *Rehabilitation Manual for Oiled Birds* (cited in References) for more information.

13.10 Material Take Off (MTO) List

Equipment Description	Use
Baby Pool	Rehabilitation
Containers for washing animals	Rehabilitation
Collapsible Nets	Rehabilitation
Danger Tape	Rehabilitation
Detergent/soap	Rehabilitation
Water dechlorinator	Rehabilitation
Drum Liners/Trash Bags	Rehabilitation
Food	Rehabilitation
Heat Lamps	Rehabilitation
Hot Water	Rehabilitation
Towels	Rehabilitation
Kennels	Rehabilitation
Decoys	Hazing
Mist netting and net gun	Hazing
Propane cannon	Hazing
Reflective tape	Hazing
Scarecrow	Hazing
Seine net	Hazing
Traps	Hazing
Wildlife Camera	Hazing
Freezer	Medical
Antiseptic solutions	Medical
Bandaging materials	Medical
Sterile instruments	Medical
Syringes and catheters	Medical
Dissection instruments	Medical
Diagnostic equipment	Medical

14 Waste Management

14.1 Introduction

Waste disposal is a major oil spill response consideration. For large spills, as much waste can be generated as the amount of oil spilled and in some cases considerably more. In the 2002 Prestige spill, almost twice as much waste was collected as was spilled (117,000 tons vs. 63,000 tons spilled). It is important to develop waste management strategies that minimize the amount of waste generated by the response including oiled material as well as non-oiled material. Some response options, such as dispersants and burning, can significantly reduce the volume of waste generated.

A good practice is to remove debris from shorelines BEFORE the oil impact. Since oil recovery operations are rarely conducted near existing waste management facilities, it is critical to pre-identify, evaluate, and select waste management logistical infrastructure (trucks, containers, etc.) as well as storage and disposal options. Decisions regarding logistics, storage and disposal will depend on the size of a spill, its location, and local or regional regulatory requirements. Refer to the IPIECA Report Series, “Guidelines for Oil Spill Waste Minimization and Management” and ITOPF’s Technical Information paper ‘Disposal of Oil and Debris’ for additional useful information.

Response to spills that will involve storing wastes for more than a few days should include the following:

- A thorough review of the applicable laws and regulations.
- Development of storage and disposal plans.
- Permit acquisition.

14.2 Waste Management and Regulations

Treatment, storage, handling, and disposal of waste materials may be subject to a variety of local, regional, and national laws and regulations, and may require special permits and/or other approvals. Oil spill wastes in some areas are considered “hazardous wastes” and are subject to special regulation. It is important to note that the legal responsibility of a waste generator begins from the time the waste is generated until final disposition.

14

Proper hazardous waste identification is necessary to appropriately manage the disposal of wastes. We can evaluate if a waste can be considered a hazardous waste by asking two questions: 1) Is the waste a listed hazardous waste? or 2) does it exhibit a characteristic of a hazardous waste? Plans for handling and temporary storage of wastes during initial stages of an oil spill response should be discussed with local stakeholders as well as regulatory agency personnel. It is suggested that local consultants be contacted. For example, some waste management companies

also offer emergency response services such as hazardous waste storage, transport and disposal and hazmat personnel.

Special consideration should be given to storage of wastes, depending on the anticipated quantity or volume, especially if the waste can be considered a hazardous waste. These considerations should include compatibility of the waste with the storage container in which the wastes are going to be placed; consideration of the odor or vapors that may be released into the atmosphere; and consideration of the characteristics and/or any chemical reactions that could be taking place with the wastes.

When developing waste minimization strategies, it is important to include waste management options that focus on recycling, reuse, and reclamation. While such options may have initial costs, the benefit in terms of elimination of future potential liability is often worth these added costs. Consideration of waste disposal operations should begin immediately upon the commencement of spill response efforts.

During any size response precautions must be taken to ensure worker safety and proper handling to minimize potential future liability. Suggestions included:

- Extensive photo / electronic documentation of any temporary storage sites as well as the operational area should be gathered; before, during and after the cleanup is finished.
- Secondary containment (i.e., placement of synthetic liners) should be placed under storage containers to prevent soil contamination.
- Storage container covers are essential to prevent rainwater entering which may cause the oil to float or overspill plus increasing the volume of oiled waste to be disposed which has cost implications.
- Secondary contamination of the immediate area / vehicles / personnel / roads from oily waste should be considered and actions taken to minimize this in the form of decontamination stations for personnel and vehicles.
- Testing, evaluation, inventorying, labeling, profiling and manifesting of wastes should be done in order to document that proper precautions, procedures, and regulations are followed.
- Security should be provided to prevent unauthorized dumping, vandalizing, and to ensure that waste storage does not endanger other parties.

A waste management plan following an oil spill should be based on the following principles:

- Provide safe working conditions and necessary personnel protection.
- Comply with all applicable laws and regulations.
- Minimize the amount of waste generated by implementing waste reduction principles.
- Minimize the possibility that disposed wastes will cause future environmental problems or require future remediation.
- Personnel handling hazardous wastes must be appropriately trained for such handling as mandated by governmental and regulatory agencies.
- Provide sufficient temporary and interim storage to prevent any bottleneck of recovery operations.
- Minimize risks of secondary pollution incidents in all operations.
- Cooperate with all local community and government agencies to minimize impacts on local waste disposal facilities.
- Handle, store, and transport oily wastes in appropriate containers/tanks.
- Consider response strategies that focus on segregation of waste streams at initial collection
- Segregate oily wastes and non-oily wastes to allow optimum reclamation and disposal of each waste stream.
- Sample and characterize each waste stream in order to understand risks and appropriate regulations.
- Complete appropriate waste profiles and submit to the selected disposal facility(ies) for approval.
- Dispose of all waste streams in a safe manner and at approved disposal sites.

14.3 Storage Equipment

Oil spill response operations can very quickly generate large volumes of waste. Completing arrangements for permanent disposition of wastes may require a great deal of time that could delay recovery operations. Therefore, facilities for temporary storage of waste should be provided. There are many temporary storage options that can meet operational requirements, including commercial products specifically designed for oil spill response, general-purpose devices, and containers of opportunity.

The selection of appropriate storage equipment and methods is based on the type and volume of material to be stored. The following factors should be considered:

- Storage location, e.g., offshore, onshore, or near shore.
- Storage capacity required.
- Type of material to be stored; e.g., fresh, emulsified or weathered oil, oil mixed with debris such as sorbents, sticks, trash, logs, seaweed, fishing equipment, sand, gravel, pebbles, cobbles.
- All wastes, especially hazardous wastes, should be protected from exposure to heat, fire, weather and should be secured. Containers which are used to store hazardous wastes should be compliant with all regulations.
- Duration of storage; e.g., days, weeks, or months.
- Access to storage sites.
- Consideration of storage in environmentally sensitive areas i.e., wildlife reserves during nesting seasons.
- Consideration should be given to the usage of regulatory-approved and / or performance-oriented shipping containers.
- Expected method of disposal.

Note that waste accumulation and storage locations should meet the following criteria:

- Spill prevention, control and countermeasures are in place.
- Storm water pollution prevention plans (rain water collection and control).
- Have severe weather (e.g., hurricane, flooding, etc.) contingency plans
- Ample storage space for the segregation of wastes which are not compatible.
- An emergency response plan should be developed for the waste accumulation/ storage location(s).

Table 14-1 lists options for storage of wastes and debris associated with oil spill cleanup operations and the appropriate timeframe for their use.

Table 14-1 Storage Options

Type of Storage	Estimated Timeframe for Use
Air (Inflatable) berm	Initial (days)
Container of opportunity	Temporary (weeks)
Deck barge with deck tanks (Must be regulatory approved)	Temporary (weeks)
Drum 55-gallon (208 liter)	Initial (days) - temporary (weeks)
Dumpster, Roll-On/Roll-Off	Temporary (weeks) - semi-permanent (months)
Dump truck (lined)	Initial (days)
Earthen dike (snow berm)	Initial (days)
Earthen pit (ice pit)	Initial (days)
Flexible, towable tank/bladder	Initial (days) and Temporary (weeks)
Fractionation ("Frac") Tanks, 21,000 gallon capacity	Initial (days) – temporary (weeks)
Heavy duty plastic trash bag	Initial (days) - temporary (weeks)
Livestock tank	Initial (days) - temporary (weeks)
Oilfield tank	Semi-permanent (months)
Open-top barge, lash barge, or hopper barge	Temporary (weeks)
Pillow tank	Initial (days) - temporary (weeks)
Plastic swimming pool	Initial (days)
Prefabricated kit	Initial (days) - temporary (weeks)
Skimmer vessel	Initial (days)
Supply boat with deck tanks	Temporary (weeks)
Tank barge	Temporary (weeks) - semi-permanent (months)
Tanker	Semi-permanent (months)
Tank truck	Temporary (weeks)
Vacuum or air conveyor truck	Initial (days) - temporary (weeks)

14.4 Storage Selection Guides

This section presents information on suitable options for temporary offshore and onshore / near shore storage according to spill size, oil weathering, and debris content.

The storage selection guides are used as follows:

1. Determine the appropriate storage selection guide [either offshore (Table 14-2) or onshore/near shore (Table 14-3)].
2. Estimate the storage capacity that will be needed.
3. Select the type of material to be stored; e.g., fresh or weathered oil, and with or without debris.
4. Estimate the required storage timeframe (Table 14-1).
5. Choose from storage options in the appropriate storage selection guide, Table 14-2 or Table 14-3, that are denoted by a ✓.
6. Consult Tables 14-4 through 14-25 for more information on each option.
7. Follow regulatory requirements for waste stream and container.

It is assumed that there will be no debris collected during offshore recovery (Table 14-2). If debris is present from an offshore spill, use the onshore/nearshore guide (Table 14-3). Care should be taken if oiled debris contains plant or animal matter because potentially dangerous gases can accumulate in closed storage devices.

Table 14-2 Offshore Storage Selection Guide

Offshore Storage					
Option	Spill Size ¹			Oil	
	Small	Medium	Large	Fresh ²	Weathered
Deck barge with deck tanks	✓	✓	✓	✓	✓
Drum (55 gallon)	✓			✓	✓
Flexible towable tank	✓	✓	✓	✓	
Open-top, lash, or hopper barge		✓	✓		✓
Skimmer vessel	✓			✓	✓
Supply boat with deck tanks	✓	✓	✓	✓	✓
Tank barge		✓	✓	✓	✓
Tanker			✓	✓	✓

- ¹ Small <100 bbl (<16 m³)
 Medium 100–1000 bbl (16–160 m³)
 Large >1000 bbl (>160 m³)

- ² Fresh, volatile oils should not be stored in open-top devices if vapors pose a health and/or safety risk.

Table 14-3 Onshore/Nearshore Storage Selection Guide

Offshore Storage								
Option	Spill Size ¹			Oil Debris			Oil	
	Small	Medium	Large	Small Light	Large Heavy	Sand or Gravel	Fresh ²	Weathered
Air (Inflatable) berm	✓					✓	✓	✓
Boom	✓	✓		✓	✓		✓	✓
Livestock Tank	✓	✓		✓	✓	✓	✓	✓
Deck barge with deck tanks			✓				✓	✓
Drum (55 gallon)	✓			✓		✓	✓	✓
Dump truck (lined)	✓				✓			✓
Earthen berm, earthen pit or snow berm	✓	✓		✓	✓	✓	✓	✓
FRAC tank	✓	✓		✓	✓		✓	✓
Heavy duty plastic trash bag	✓			✓		✓		
Oilfield tank	✓	✓	✓				✓	✓
Open-top, lash, or hopper barge			✓					✓
Pillow tank	✓						✓	
Plastic swimming pool	✓	✓						✓
Prefabricated kit	✓	✓	✓	✓	✓	✓		✓
Roll-On/Roll-Off dumpster	✓			✓	✓	✓	✓	✓
Skimmer vessel	✓	✓		✓			✓	✓
Supply boat with deck tanks			✓	✓		✓	✓	✓
Tank barge			✓				✓	✓
Tank truck	✓	✓					✓	
Tanker			✓				✓	✓
Towable tank	✓	✓	✓				✓	✓
Vacuum or air conveyor truck	✓	✓					✓	✓

¹ Small <100 bbl (<16 m³)
 Medium 100–1000 bbl (16–160 m³)
 Large >1000 bbl (>160 m³)

² Fresh, volatile oils should not be stored in open-top devices if vapors pose a health and/or safety risk.

Table 14-4 Air (Inflatable) Berm

	
Capacity	<ul style="list-style-type: none"> • 20–70 barrels (3–10 tons)
Uses	<ul style="list-style-type: none"> • Storage of oily liquids, oily debris encircled by an air-inflated tube • Separation of oil/water and oil/debris
Auxiliary Equipment	<ul style="list-style-type: none"> • Air blower to inflate berm
Advantages	<ul style="list-style-type: none"> • Portable • Requires little storage space
Disadvantages	<ul style="list-style-type: none"> • Contents are lost if air chamber deflates

Table 14-5 Boom

	
Capacity	<ul style="list-style-type: none"> • Up to several hundred barrels
Uses	<ul style="list-style-type: none"> • Storage of oily liquids and oily debris
Auxiliary Equipment	<ul style="list-style-type: none"> • Anchors and or anchoring systems • Buoys
Advantages	<ul style="list-style-type: none"> • Adapts to any shoreline and size configuration • Readily available
Disadvantages	<ul style="list-style-type: none"> • On water applications only.

Table 14-6 Deck Barge with Deck Tank

	
Capacity	<ul style="list-style-type: none"> • 10–1000 bbls (1.6–160 tonnes)
Uses	<ul style="list-style-type: none"> • Remote site storage, especially for oily liquids, debris
Auxiliary Equipment	<ul style="list-style-type: none"> • Tugboat is required for mobilization or movement and may be required for safety in exposed locations • Portable tanks, completely enclosed for liquid or open-top for heavily weathered oil or debris, hoses, pumps, etc.
Advantages	<ul style="list-style-type: none"> • May be readily available in major ports
Disadvantages	<ul style="list-style-type: none"> • River barges may not be usable offshore due to licensing/certification restrictions (regulatory approvals); waivers take time to obtain; severe weather may make platforms unstable

Table 14-7 55-Gallon (208 Liter) Drum

Capacity	<ul style="list-style-type: none"> • 55 gal (208 liters)
Uses	<ul style="list-style-type: none"> • Liquid or oily solids storage
Auxiliary Equipment	<ul style="list-style-type: none"> • None
Advantages	<ul style="list-style-type: none"> • Easily accessible in most places • Portable
Disadvantages	<ul style="list-style-type: none"> • High weight/storage volume ratio • Can be difficult to handle by hand when full
Comments	<ul style="list-style-type: none"> • Can be carried aboard small boats or other boats to transport and store recovered materials from remote cleanup sites • Must be in regulatory approved condition for transport.

Table 14-8 Lined Dump Truck

Capacity	<ul style="list-style-type: none">• 25 yd³, 100 bbl (16 tonnes) average size
Uses	<ul style="list-style-type: none">• Short-term storage of oily debris
Auxiliary Equipment	<ul style="list-style-type: none">• Plastic line• Cover
Advantages	<ul style="list-style-type: none">• Portable• Can be easily obtained• Handles variety of oily debris
Disadvantages	<ul style="list-style-type: none">• Prone to leak liquids unless designed for liquid containment
Comments	<ul style="list-style-type: none">• Line bed with plastic to prevent oil leakage• Over the road transport of waste must be conducted in conformance with regulations.

Table 14-9 Earthen Pit, Earthen Berm, Ice Berm or Ice Pit

	
Capacity	<ul style="list-style-type: none"> • Up to several thousand barrels
Uses	<ul style="list-style-type: none"> • Shoreline storage of liquids and solids • Separation of oil from water and solids
Auxiliary Equipment	<ul style="list-style-type: none"> • Backhoe, bulldozer, or front-end loader • Pit liner (synthetic liner, usually 4.5 cm or greater thickness) that is compatible with oil; e.g., 6.0 cm high-density polyethylene or 2–3 in (5–8 cm) of clay (check regulations) • Pipe for monitoring wells (Not at all sites) • Fencing material • Bird hazing equipment • Soil tamper (optional)
Advantages	<ul style="list-style-type: none"> • Easy to install (once engineered) • Useful in many locations
Disadvantages	<ul style="list-style-type: none"> • May require permit or approval to construct • Can leak or walls can subside • May attract birds that could be injured by oil
Comments	<ul style="list-style-type: none"> • Excavated soil can be used to form an earthen dike • Surface must be packed smooth to prevent liner damage • Excavation pit can be used as additional storage • In the Arctic, water can be sprayed over snow to solidify a berm and reduce its permeability

Table 14-10 Flexible, Towable Tank (Dracone)

	
Capacity	<ul style="list-style-type: none"> • 14–12,500 bbls (2.2–2,000 tonnes)
Uses	<ul style="list-style-type: none"> • Storage of oily liquids
Auxiliary Equipment	<ul style="list-style-type: none"> • Vessel to tow tank • Transfer hose and pump • Cover
Advantages	<ul style="list-style-type: none"> • Portable • Compact for storage
Disadvantages	<ul style="list-style-type: none"> • May be difficult to empty (particularly if the contained product is viscous)
Comments	<ul style="list-style-type: none"> • Flexible tanks are fragile and must be towed slowly • Tube “dracones” are difficult to unload; “covered inflatable barges” with removable covers are easier to unload • Tank should be vented to prevent buildup of gases which may be hazardous

Table 14-11 Plastic Trash Bag or “Super Sac”

	
Capacity	<ul style="list-style-type: none"> • About 7 ft³ (0.2 m³) trash bag maximum, “Super Sacs” 50 ft³ (1.4 m³)
Uses	<ul style="list-style-type: none"> • Storage of light oily debris
Auxiliary Equipment	<ul style="list-style-type: none"> • Crane for “Super Sacs”
Advantages	<ul style="list-style-type: none"> • Lightweight • Readily available
Disadvantages	<ul style="list-style-type: none"> • Can be punctured by sharp debris, can leak • Cannot be used to store liquids
Comments	<ul style="list-style-type: none"> • Heavy duty (3–4 mm or 0.1–0.15 in) or reinforced bags are preferred • “Super Sacs” best for lightly oiled sediment

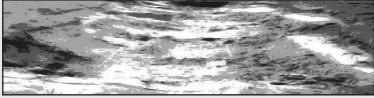
Table 14-12 Livestock Tank

	
Capacity	<ul style="list-style-type: none"> • 5–50 bbls/unit (0.8–8 tonnes/unit)
Uses	<ul style="list-style-type: none"> • Liquid or oily solids storage • Separation of oil from water and debris
Auxiliary Equipment	<ul style="list-style-type: none"> • Hand tools required to assemble large livestock tanks • Hoses • Pumps
Advantages	<ul style="list-style-type: none"> • Portable • Available in many locations
Disadvantages	<ul style="list-style-type: none"> • Bulky to store when assembled unless stackable
Comments	<ul style="list-style-type: none"> • Containers of opportunity may be fish boxes, mining containers, or any leakproof containers available in the area of the spill

Table 14-13 “Frac” Tank

	
Capacity	<ul style="list-style-type: none"> • Up to five hundred barrels
Uses	<ul style="list-style-type: none"> • Storage of liquids
Auxiliary Equipment	<ul style="list-style-type: none"> • Transfer pump(s)
Advantages	<ul style="list-style-type: none"> • Readily available in many locations • Large storage capacity
Disadvantages	<ul style="list-style-type: none"> • Can only be used for storage, cannot be transported with waste inside. • Must be decontaminated following use.

Table 14-14 "Oilfield" Tank

	
Capacity	<ul style="list-style-type: none"> • Up to several hundred thousand barrels
Uses	<ul style="list-style-type: none"> • Storage of liquids
Auxiliary Equipment	<ul style="list-style-type: none"> • Transfer system
Advantages	<ul style="list-style-type: none"> • Rapid source of large storage capacity when available
Disadvantages	<ul style="list-style-type: none"> • Heavy; not generally available • Difficult to restore for clean product use • May not be appropriate in all cases
Comments	<ul style="list-style-type: none"> • Self-dumping hopper barges may need to be lined or have doors welded shut before use

Table 14-15 Open Top Barge, Lash Barge or Hopper Barge

	
Capacity	<ul style="list-style-type: none"> • Up to several thousand bbls
Uses	<ul style="list-style-type: none"> • Remote site storage, especially for oily debris
Auxiliary Equipment	<ul style="list-style-type: none"> • Tugboat is required for mobilization or movement and may be required for safety in exposed locations
Advantages	<ul style="list-style-type: none"> • May be readily available in major ports
Disadvantages	<ul style="list-style-type: none"> • River barges may not be usable offshore due to licensing/certification; waivers take time to obtain
Comments	<ul style="list-style-type: none"> • Self-dumping hopper barges may need to be lined or have doors welded shut before use

Table 14-16 Pillow Tanks

	
Capacity	<ul style="list-style-type: none"> • 10–1000 bbls (1.6–160 tonnes)
Uses	<ul style="list-style-type: none"> • Storage of liquids • Can be used in combination with a truck for storage and transport of oil
Auxiliary Equipment	<ul style="list-style-type: none"> • Hose and pump to fill and empty
Advantages	<ul style="list-style-type: none"> • Lightweight • Easily transportable to spill site • Compacts for storage
Disadvantages	<ul style="list-style-type: none"> • Can be accidentally punctured, very hard to decontaminate • May become waste after use
Comments	<ul style="list-style-type: none"> • Some are transportable by helicopter

Table 14-17 Plastic Swimming Pools

Size	<ul style="list-style-type: none"> • Varies, 10–20 ft (3–6 m) diameter and 4–5 ft (1–1.5 m) high
Capacity	<ul style="list-style-type: none"> • Up to 1000 bbls (160 tonnes)
Uses	<ul style="list-style-type: none"> • Shoreline storage of liquid or light debris
Auxiliary Equipment	<ul style="list-style-type: none"> • Hoses and pumps
Advantages	<ul style="list-style-type: none"> • Compacts for storage • Easily transportable to spill site
Disadvantages	<ul style="list-style-type: none"> • For short-term storage only since oil deteriorates the fabric, only used for very small amounts of waste
Comments	<ul style="list-style-type: none"> • Use a heavy-duty oil-resistant liner with the pool

Table 14-18 Prefabricated Kits

	
Capacity	<ul style="list-style-type: none"> • 50–50,000 bbls/unit (8–8000 tonnes/unit)
Uses	<ul style="list-style-type: none"> • Storage of liquids and oiled debris • Separation of oil from water and solids
Auxiliary Equipment	<ul style="list-style-type: none"> • Hand tools for field assembly • Mechanical equipment to install sub grade
Advantages	<ul style="list-style-type: none"> • Portable • Dismantles for easy storage
Disadvantages	<ul style="list-style-type: none"> • Requires flat surfaces
Comments	<ul style="list-style-type: none"> • Large units may require multiple days to assemble by unskilled workers

Table 14-19 Skimmer Vessel

	
Capacity	<ul style="list-style-type: none"> • Up to a few hundred bbls
Uses	<ul style="list-style-type: none"> • Initial storage of recovered oil
Auxiliary Equipment	<ul style="list-style-type: none"> • Transfer hose and pump
Advantages	<ul style="list-style-type: none"> • Portable
Disadvantages	<ul style="list-style-type: none"> • Very limited volume (hours of use at most)
Comments	<ul style="list-style-type: none"> • This storage can only be used for a limited period without transfer if the skimmer is to remain in operation

Table 14-20 Supply Boat with Deck Tanks

Capacity	<ul style="list-style-type: none"> • 10–1000 bbls (1.6–160 tonnes)
Uses	<ul style="list-style-type: none"> • Mobile storage and transfer from skimmers to shore for disposal
Auxiliary Equipment	<ul style="list-style-type: none"> • Portable tanks that are closed for liquid or open for heavily weathered oil or debris; e.g., debris containers and roll-on/roll-off dumpsters
Advantages	<ul style="list-style-type: none"> • Highly mobile; can transit between spill site and shore at over 10 kts (5 m/sec)
Disadvantages	<ul style="list-style-type: none"> • Some vessels cannot tolerate addition of much topside weight because of stability concerns in severe weather • Limited deck space • May need regulatory approval for tanks, or receive waiver as needed.

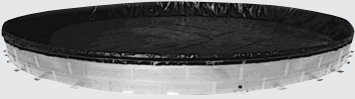
Table 14-21 Tank Barge

Capacity	<ul style="list-style-type: none"> • Up to several thousand bbls
Uses	<ul style="list-style-type: none"> • Storage of liquids and weathered oil
Auxiliary Equipment	<ul style="list-style-type: none"> • Tugboat • Transfer hose and pump
Advantages	<ul style="list-style-type: none"> • Large volumes • Portable
Disadvantages	<ul style="list-style-type: none"> • Slow transit speed to spill site • Limited availability in remote areas • May have too much freeboard (when empty) to receive recovered oil from small skimmers
Comments	<ul style="list-style-type: none"> • When available, one of the best storage options for medium/large oil spills • Internal transfer pumps may be damaged by debris; external transfer pumps may be required for offloading • Heating coils help when pumping viscous products • Barge capacity of 10,000–20,000 bbls (1,600–3,200 tonnes) preferred • Decontamination after use is huge issue and generates more waste.

Table 14-22 Tank Vessel

Capacity	<ul style="list-style-type: none"> • Typically hundreds of thousands of bbls
Uses	<ul style="list-style-type: none"> • Storage of liquid and heavy oils
Auxiliary Equipment	<ul style="list-style-type: none"> • Transfer hose and pump
Advantages	<ul style="list-style-type: none"> • Portable • Large volume
Disadvantages	<ul style="list-style-type: none"> • Not normally available for oil spill response operation; deep draft and high freeboard
	<ul style="list-style-type: none"> • Regulations for use in oil recovery and at-sea transfer operations apply in some countries
	<ul style="list-style-type: none"> • Decontamination of vessel following use for waste is very difficult
Comments	<ul style="list-style-type: none"> • Probably the best storage option available for responding to a tanker spill, especially to lighter a stricken tanker

Table 14-23 Tank Truck

	
Capacity	<ul style="list-style-type: none"> • Up to 130 bbls (20 tonnes)
Uses	<ul style="list-style-type: none"> • Storage of liquids with minor quantities of debris
Auxiliary Equipment	<ul style="list-style-type: none"> • None
Advantages	<ul style="list-style-type: none"> • Can be easily obtained • Portable • Can transport oil to disposal site
Disadvantages	<ul style="list-style-type: none"> • Difficult to restore for clean products use (decontamination of tank is difficult)

Table 14-24 Vacuum or Air Conveyor Truck

	
Capacity	<ul style="list-style-type: none"> • Large vacuum tanker, up to 130 bbls (20 tonnes)
Uses	<ul style="list-style-type: none"> • Short-term storage of liquids and oil solids • Separation of oil and water
Auxiliary Equipment	<ul style="list-style-type: none"> • None
Advantages	<ul style="list-style-type: none"> • Portable
Disadvantages	<ul style="list-style-type: none"> • May not be readily available or may be in short supply depending on spill location • Vacuum transfer to storage (e.g gulley-sucker) should not be used for volatile products

Table 14-25 Roll-On/Roll-Off Dumpster



Capacity	<ul style="list-style-type: none"> • 20 yd³, 80 bbl (13 tonnes) average size
Uses	<ul style="list-style-type: none"> • Storage of oily debris
Auxiliary Equipment	<ul style="list-style-type: none"> • Plastic liner • Cover
Advantages	<ul style="list-style-type: none"> • Can be easily obtained • Handles variety of oily debris
Disadvantages	<ul style="list-style-type: none"> • Prone to leak liquids
Comments	<ul style="list-style-type: none"> • Line bed with plastic to prevent oil leakage • Cover dumpster to exclude precipitation and help control vapors depending on waste type

14.5 Waste Stream Segregation and Minimization

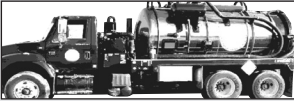
Each type of waste has different optimal disposal methods. It is important to:

- Segregate wastes by type.
- Minimize the quantity of each type.
- Avoid mixing hazardous and non-hazardous wastes together to prevent creating a larger volume of hazardous waste.
- Avoid mixing oiled and non-oiled (PPE / pre-cleaned debris from shoreline, domestic waste) together to prevent creating larger volumes of oiled waste.
- Label all waste containers and identify the source.

Waste can be segregated according to the following chart:

 <p>Liquid</p>	<p>Oily</p> <ul style="list-style-type: none">• Further segregate for final disposal• Reclaim at existing oil recycling/reclamation facility <p>Non-oily</p> <ul style="list-style-type: none">• Process through municipal plant or other approved method• Construct closed loop systems that generate small volumes of waste
 <p>Solid</p>	<p>Oily</p> <ul style="list-style-type: none">• Transport to central waste processing center• Further segregate for final disposal <p>Non-oily</p> <ul style="list-style-type: none">• Transport to shore for disposal at local landfills, Waste To Energy facilities• In Europe “zero” landfill policies may make this option extremely expensive for any type of waste
 <p>Special Wastes</p>	<p>Hazardous</p> <ul style="list-style-type: none">• Segregate and handle in accordance with regulations <p>Non-hazardous</p> <ul style="list-style-type: none">• Maintain as separate waste stream until disposed

Guidelines for minimizing the amount of waste generated are listed in the following sub-sections.

14.5.1 Solid wastes

- Establish response strategies / procedures that segregate materials at collection.
- Do not mix any oil or oily wastes with domestic or non-oiled waste.
- Prevent oily wastes from contaminating soil: use liners underneath drums, tanks, and cleaning operation sites.
- When using manual cleanup methods, minimize the amount of underlying clean sediments that are collected.
- In some instances, use of non-hazardous detergents can be utilized to clean solids impacted by oily wastes (Note: this will most likely require additional approvals and may also generate a new waste stream that requires separate handling and characterization).
- Whenever any neat product or chemical is utilized, use all material in containers and wash out the residue in place (this may require the approval of regulatory agencies).

14.5.2 Liquid wastes

- Prevent water or debris from entering containers. Decant when permitted to minimize volumes and concentrate emulsions
- Determine disposal implications before using chemicals; depending on the chemical properties, non-hazardous oil can be considered as hazardous for disposal purposes.
- Use cleaners and wash water sparingly. Consider closed loop cleaning/ decontamination systems to minimize waste.
- Use decanting methodologies for recovered oil and water mixtures on site. This practice is approved in certain areas when proper protocols are applied (i.e., water treatment and discharge via a regulatory agency permit).

14.6 Disposal Methods

Non-oily wastes (e.g., PPE, sewage, domestic waste) generated during cleanup operations can be disposed of at local wastewater treatment plants and municipal landfills. In some countries, current “zero” landfilling initiatives may heavily impact selection of the preferred disposal method. Disposal taxes and other fees may influence the selection of options typically thought of as more expensive, but are preferred for financial as well as long term environmental liability management reasons.

Options for disposing of oiled and hazardous wastes (subject to regulatory requirements) include:

- Industrial landfilling
- Landfarming
- Open burning
- Portable incineration
- Commercial incineration, waste to energy facilities
- Reprocessing
- Reclaiming/recycling

With regard to sewage or septic wastes, it is important to note and consider that some areas require different permitting for storage and/or transportation of this type of wastes.

Further information on each disposal alternative above is provided in the tables below.

Table 14-26 Industrial Landfilling

Disposal Rate	<ul style="list-style-type: none">• Depends on local capacity and access constraints, as well as governmental restrictions
Uses	<ul style="list-style-type: none">• Disposal of bulky oil spill waste such as sea grass, shoreline vegetation, wood, sand, and general oiled trash
Auxiliary Equipment	<ul style="list-style-type: none">• Earth-moving equipment and trucks
Advantages	<ul style="list-style-type: none">• Useful for a wide variety of debris types• Can be implemented rapidly
Disadvantages	<ul style="list-style-type: none">• Can lead to future environmental problems if containment fails
Comments	<ul style="list-style-type: none">• Total volume of debris accepted per site may be small• Be sure site is permitted to accept each specific waste stream• Be sure site is on approved waste site list

Table 14-27 Landfarming

Capacity	<ul style="list-style-type: none"> • Application rates for crude oils are typically 300 bbl/acre (120 tonnes/hectare) at a rate of 2–3 times/year
Uses	<ul style="list-style-type: none"> • Disposal of liquids and oil mixed with sand or sediment
Auxiliary Equipment	<ul style="list-style-type: none"> • Transport truck • Tillers • Fertilizer
Advantages	<ul style="list-style-type: none"> • Proven method used by hydrocarbon processing plants for many years to dispose of oils and oily sludges • Oil degrades rapidly • Can be implemented quickly
Disadvantages	<ul style="list-style-type: none"> • Requires large linear surface area • Periodic maintenance is required to fertilize, till, and spread • Not a final disposal option, often used to reduce concentration of oil or to generate a useable product (road base, containment berms at industrial facilities). • There may be significant permitting and regulatory requirements at sites other than existing landfarms
Comments	<ul style="list-style-type: none"> • Local officials and refinery operators are useful sources of information • The location should be on the contingency plan list of approved facilities • Opportunities to use this strategy are becoming limited due to increased regulation and control

Table 14-28 Open Burning

Disposal Rate	<ul style="list-style-type: none"> • Depends on the volume of oily waste and debris
Uses	<ul style="list-style-type: none"> • Disposal of bulky combustible debris such as sorbents, vegetation, and logs
Auxiliary Equipment	<ul style="list-style-type: none"> • Earth-moving equipment and trucks • Fire-fighting equipment • Air blowers • Smoke suppression chemicals
Advantages	<ul style="list-style-type: none"> • Useful in remote areas • Eliminates large volumes of waste, residue will still need to be handled. • Can be quickly implemented
Disadvantages	<ul style="list-style-type: none"> • Air emissions may be a problem • Requires governmental permission in most locations • Can cause contamination of underlying soils • Incomplete combustion may leave residue requiring disposal
Comments	<ul style="list-style-type: none"> • Burning is often conducted by excavating several ditches and alternately loading and burning in each one • A recommended safety procedure is to cover residue with a layer of dirt to prevent smoldering embers from prematurely igniting the next load being placed in a pit • Air blowers may be required to improve combustion and to control smoke emissions

Table 14-29 Portable Incineration – Offshore Burners (Liquids)

Disposal Rate	<ul style="list-style-type: none"> Up to 15,000 bbl (2,400 tonnes) per day
Uses	<ul style="list-style-type: none"> Incineration of pure oil and emulsions, either offshore on platforms and barges or on land
Auxiliary Equipment	<ul style="list-style-type: none"> A method to mount a burner away from heat-sensitive areas (e.g., tower, boom, or shielding) Air compressor Oil pumps (high pressure) and hoses Water pumps for water shroud Note: auxiliary equipment may be supplied by manufacturer
Advantages	<ul style="list-style-type: none"> Proven method of disposal but may not be available High rates of disposal doubtful Useful in remote areas Can be used to increase the efficiency of burning oil or solid waste materials in the field
Disadvantages	<ul style="list-style-type: none"> Requires time to set up (unless already mounted on a platform or barge) including permitting. Significant amounts of diesel or fuel may be required to reduce viscosity of emulsions to be pumped Requires debris-free oil or emulsions May require permit depending on location

Table 14-30 Portable Incineration – Air Curtain Incinerators

Disposal Rate	<ul style="list-style-type: none"> Oily debris, up to 1–2 tonnes per hour Oil emulsions up to 600 bbl (100 tonnes) per day
Uses	<ul style="list-style-type: none"> On land disposal of liquids and oily debris
Auxiliary Equipment	<ul style="list-style-type: none"> Earth-moving equipment to form earthen incinerator pit System to load debris or liquids Above-ground combustion chamber (optional in some cases)
Advantages	<ul style="list-style-type: none"> Portable systems for disposal of waste in the field Medium disposal rates Permanent disposal of waste will still have residue to address and dispose Accepts both liquids and solids
Disadvantages	<ul style="list-style-type: none"> Requires time to set up and may require permitting
Comments	<ul style="list-style-type: none"> Several types of air curtain incinerators are manufactured; some are designed to be used only with above-ground chambers, while others are designed to be used within ground trenches, and some with either.

Table 14-31 Portable Incineration – Rotary Kiln/Other Portable Devices

Disposal Rate	<ul style="list-style-type: none"> • Oily debris, up to 40–70 tonnes/day • Oiled sediments, 100 tonnes/day (possibly more) • Maximum about 1 tonnes/hour (based on oil content)
Uses	<ul style="list-style-type: none"> • Disposal near the source of oily sorbents, etc. • Remediation of contaminated soils near the source
Auxiliary Equipment	<ul style="list-style-type: none"> • Size reduction equipment (shredder or chipper) may be needed, depending on incinerator type and debris size
Advantages	<ul style="list-style-type: none"> • High disposal rate • Permanent disposal of waste oil and oiled combustibles such as soiled gear and spent sorbents • May accept both liquids and solids
Disadvantages	<ul style="list-style-type: none"> • Requires time to construct/mobilize • Air emission permit may be needed • Portable ones (not currently in use) may not be an option due to permitting and approvals needed, existing fixed facilities in the theatre of operations are options.

Table 14-32 Commercial Incineration

Disposal Rate	<ul style="list-style-type: none"> • Up to several hundred bbls/hr (several tonnes/hr)
Uses	<ul style="list-style-type: none"> • Disposal of both liquids and solids
Auxiliary Equipment	<ul style="list-style-type: none"> • An efficient storage and transportation network
Advantages	<ul style="list-style-type: none"> • Permits usually already in place • Quick to implement if close to cleanup site • Safe • Controlled emission release
Disadvantages	<ul style="list-style-type: none"> • Most incinerators are designed to burn a narrow range of products
Comments	<ul style="list-style-type: none"> • Incinerators are located at refineries, hazardous waste disposal sites and waste reclamation plants.

Table 14-33 Reprocessing/Recycling

Disposal Rate	<ul style="list-style-type: none"> • Several hundred bbls/hr (several tonnes/hr)
Uses	<ul style="list-style-type: none"> • Disposal of debris-free oils and emulsions
Auxiliary Equipment	<ul style="list-style-type: none"> • None
Advantages	<ul style="list-style-type: none"> • Oil is recycled
Disadvantages	<ul style="list-style-type: none"> • Facility must be convenient and permitted
Comments	<ul style="list-style-type: none"> • Sites that accept oil include refineries, pipeline pump stations, terminals and production facilities • Some locations with oil/water separators can accept debris-free emulsions

Table 14-34 Reclaiming/Recycling

Disposal Rate	<ul style="list-style-type: none"> • If storage facilities are available at the plant, disposal rates can be high
Uses	<ul style="list-style-type: none"> • Disposal of oil or emulsions with small amounts of sand, gravel or debris (<5%) • Disposal of weathered oil
Auxiliary Equipment	<ul style="list-style-type: none"> • None
Advantages	<ul style="list-style-type: none"> • Oil could be salvaged • Oil could be sold
Disadvantages	<ul style="list-style-type: none"> • Location must be convenient to cleanup site

14.7 Transportation

Transportation of oil spill wastes as well as waste oil is subject to a variety of regulations in many countries. Placards (special signage) may be required for trucks transporting waste oil. Usually, these placards must comply with regulations that stipulate a symbol, hazard class and number that identify the material. Placards must be clearly visible from the back and sides of the vehicle. Special permits may also be required for transport vehicles, as well as shipping documents/manifests that indicate the type of material being transported. A journey management plan as well as a transportation contingency plan may be part of the regulatory requirements (e.g., preferred routing, emergency contacts, product data, and spill cleanup procedures). In some locations, if a waste spill occurs during transport, a notification to regulatory authorities may be required within a specified time period.

Trans-border disposal is subject to complex regulations and can be conducted after the appropriate authorities have been notified and clearance has been obtained. This may include meeting the requirements of each country involved, including an approved ultimate disposal method/location. Truck drivers and equipment operators transporting wastes should be trained and licensed accordingly. Drivers and operators should review and be aware of any transportation security plans, transportation contingency plans and have a copy of the Material Safety Data Sheet for the oil type if known.

14.8 Material Take Off (MTO) List

In addition to the specific auxiliary equipment items addressed for each type of storage equipment (see Table 14-1), other items are often required to successfully conduct waste management/disposal operations.

Equipment	Use
Dump trucks	Removal of oiled material
Vacuum trucks	Removal of pooled liquid
Garbage cans	Removal of oiled material
Flatbed trucks	Removal of oiled material
Liners	Lining storage containers and storage areas
Protective clothing	Personal protection equipment
Incinerators	Burning of oiled materials
Heavy duty clear plastic bags	Enclosing and segregating waste
Buckets / shovels	Removal of oiled material
Pumps/hoses/connectors	Transfer

15 Spill Response in Cold Regions

15.1 Introduction

Response in a cold environment must take into account its unique physical, biological, oceanographic and atmospheric features in developing proper response strategies and contingency plans. Precautions must be integrated into safety plans and training due to inherent dangers of working at low temperatures. Low temperatures can affect the efficiency and effectiveness of both equipment and personnel. Low temperatures resulting in formation of ice can improve or reduce accessibility.

15.2 Safety and Health Considerations

The main safety concerns in cold environments are low temperature, ice, fog, and snow. Proper protective clothing is essential to guard against frostbite and hypothermia (Refer to Section 2.2.3.2 and Table 2-6). Replace any wet clothing and boots as soon as possible. Cold environments also tend to be remote so one should be prepared for the added dangers of travel breakdowns and wildlife. When traveling over cold water by air or sea, cold-water survival suits can extend survival time in the event of accidental immersion. Speed is essential when rescuing a person who has fallen overboard. It is critical that field workers stay in communication with operations and rescue bases.

Other safety and health issues associated with low temperature response are:

- The probability of slips, trips, and falls escalates dramatically with icy surfaces.
- The daylight period in winter is typically short. Adjust work shifts accordingly to allow sufficient time for safe return to the staging area.
- In offshore environments, ice may be dynamic. Conditions can change rapidly and wind shifts may cause ice leads to open and close quickly or shore-fast ice can break and float away.
- Weather patterns can change rapidly. Frequent weather updating is essential.
- Train all workers to recognize symptoms of hypothermia and frostbite (Table 2-6) and to provide appropriate first aid.
- Medical facilities may not be available in remote areas. Teams should arrange for their own medical staff and equipment.
- Low temperatures reduce the rate of volatile emissions. Gases like benzene and hydrogen sulfide may persist longer than normal; however, slower emission rates should reduce their concentration in air.
- Health specialists need to ensure that subsistence fish, shellfish, and wildlife are safe for consumption.
- Exercise care to avoid fire or explosion risks as vapors persist longer. When drilling holes in ice, hydrocarbon gases may be present beneath, especially over an ongoing well blowout or pipeline leak.

15.3 Effects of Low Temperature on Oil

Low temperature affects hydrocarbons in ways that have implications for response:

- Oils with higher pour points can solidify in the cold, which will affect the response strategy. Under certain conditions, solidification could make recovery on land or water easier.
- Oil viscosity increases at low temperature so recovery, burning and dispersion could become more difficult for some oils.
- Loss of light ends (weathering) slows down at lower temperatures, which can offset some of the temperature effect on viscosity. The evaporation rate at 5°C is approximately 1/3 of what it is at 30°C.
- Phenomena that depend on weathering, such as emulsification and tar ball formation, should take longer to occur.
- Biological recovery on shorelines may be slower, though many organisms grow well at near-freezing temperatures. Biodegradation of oil occurs at a somewhat slower rate compared to temperate conditions. Biodegradation is likely to stop if shorelines freeze solid.

15.4 Environmental Factors That Can Affect Cold Region Response

Unique environmental factors—not found in temperate and tropical climates— influence response in cold regions. Some factors have positive effects whereas others will have negative impacts on response strategies and tactics.

15.4.1 Positive Influences on Response

- Cold temperatures slow the weathering process so oils may remain amenable to treatment by recovery, burning, and dispersion for a longer period.
- Cold, viscous oil will spread more slowly providing additional time for response.
- Frozen conditions can facilitate response by providing a solid working platform, reducing the oil's mobility, and providing natural storage capacity for oil on and under ice.
- Snow and ice can be used to contain oil. Snow is also an effective sorbent.
- Water is at or near its maximum density so heavier oils are less likely to sink.
- There is a lower incidence of highly sensitive habitats, such as tidal flats and salt marshes in Arctic regions. Vulnerable times for key sensitivities typically are shorter than in temperate and tropical settings. Therefore, planning protective strategies should be more straightforward.

- Land-fast ice causes significant annual impacts to intertidal biological communities. Concerns about adverse oil spill impacts on intertidal communities are not as much of an issue where land-fast ice occurs in winter and scours shorelines annually.
- Land-fast ice can protect the shoreline from oiling.
- Ice can limit oil penetration on beaches.

15.4.2 Negative Influences on Response

- Oil will be more difficult to recover in dynamic ice-laden waters due to access limitations and safety concerns.
- Thoroughly dry equipment such as pumps, spray booms, and nozzles after use to minimize residual water that can freeze, causing damage or limiting use.
- Diversity of marine biota in colder regions is lower than in warmer regions. Re-colonization may take longer in arctic settings than in temperate or tropical areas.
- Equipment will be more difficult to operate, especially skimmers, in broken ice.
- There is usually poor infrastructure and few roads. Transport of equipment can be a serious challenge.
- Dynamic ice floes can damage booms, vessels, and skimmers.
- Disposal of oily wastes could be an issue in remote and sensitive (e.g., tundra) areas. Wastes may have to be transported long distances. To limit transportation risks, local incineration may be an attractive alternative.
- Shoreline protection strategies may not be possible in broken ice or in the presence of large, moving ice floes.
- The salinity of ice-laden water can vary significantly. Consider this when selecting dispersants whose effectiveness depends on higher salinity.

15.5 On Water Response Options

The development of spill response strategies in cold regions will depend almost exclusively on the season during which a spill occurs. Depending on the time of year, responders could be facing a spill in open water, broken ice, or solid ice. Response considerations for each of these conditions are presented below.

15.5.1 Open Water

Spills in open water in cold regions are treated the same as in temperate and tropical climates. The only difference is the temperature of water and associated safety issues (see Section 15.2).

15.5.1.1 Containment and Recovery

The first step is to identify the spilled oil's physical properties, particularly the pour point. If the pour point is 5–10 degrees above ambient water temperature, there is a strong possibility that the oil has already solidified. Nets and other collection devices will be required for recovery. If the pour point of the spilled oil is below the water temperature, and if currents and wind conditions allow, then booms and skimmers are applicable (see Sections 5 and 9 for selection information).

15.5.1.2 In-Situ Burning

Even if a spilled oil has cooled and is solidifying into a gel, burning should be applicable as long as conditions are appropriate (see Section 8). The oil may be more difficult to ignite at low temperature but once burning begins, it will continue regardless of ambient temperature. Extra igniter fluid or accelerant (e.g., diesel or gelled gasoline) may be needed. Most crude oils should still be burnable within 2–5 days of the spill and may be burnable for extended periods, as low temperatures will slow weathering.

15.5.1.3 Dispersants

Considerable laboratory, wave basin, and field data exist which indicate that dispersants should be effective in open water conditions even at a low water temperature of 0°C (32°F). While viscosity increases as the temperature drops, effective dispersion may still occur even if the crude oil viscosity exceeds 10,000 cSt. It is important that water temperature should be above the oil's pour point. Most dispersants are formulated to be fluid and spray smoothly even at temperatures below freezing. However, if dispersants are applied using a diluting water carrier, take care to keep the spray boom and nozzles from freezing between uses.

15.5.2 Broken Ice

Periods of seasonal transition occur during early winter freeze-up and spring ice breakup. This ice is likely to be moving, not stationary. Oil spilled into such broken ice will move with the ice. Oil slicks tend to spread far less and remain thicker in broken ice conditions than in open water.

During freeze-up, diminishing open water can exert a time pressure for response. Open water response techniques can be used up to about 30% ice cover but there are limitations of access and safety. In ice concentrations greater than “close pack”

(>60% ice coverage), the sea ice provides a natural containment and can serve to physically limit oil spreading. However, safe access can be limited for vessels, equipment, and responders.

15.5.2.1 Containment and Recovery

Booms are of little or no use in large moving ice floes or in ice concentrations > 30%. Boom material selection is extremely important for durability, with conveyor belting booms being preferable to those made of PVC or polyurethane. Anchoring booms in broken ice can be difficult or impractical and frequent tending is essential once anchored.

Skimmers work best when positioned in open water and in leads between ice pieces. The most appropriate skimmers for ice-laden waters are oleophilic:

- Rope mop
- Sorbent lifting belt
- Brush
- Paddle belt
- Drum

Recovered oily fluid can contain significant amounts of slurry and/or slush ice. Be sure to provide sufficient storage and oil/water separation capacity.

15.5.2.2 In-Situ Burning

Burning is an optimum response strategy for spills in broken ice, subject to the conditions listed in Section 8, and may be the preferred option if it is unsafe to work in or on ice. Deployment of a fire-resistant boom may not be feasible in broken ice. In some cases booms may be unnecessary, as some oil may be contained by the ice. Typically, oil contained between ice leads and along the edges burns at a rate faster than skimmers can otherwise recover it.

In very close pack ice (>90% coverage), ice-breaking vessels can be used to carefully break ice around a spill site to expose trapped oil for burning. Oil in broken ice can be ignited by dropping a torch or flame from a helicopter into pooled oil. Due to reduced evaporation rates, burning in broken ice may be possible for extended periods—up to several months after a spill occurs—particularly if oil is trapped in or below ice in which case evaporation is insignificant.

15.5.2.3 Dispersants

Dispersants can be effective on spills in broken ice if there is some mixing energy present. The pumping action of waves in brash ice and between ice floes can provide the required energy. Tests have shown that bobbing brash ice can actually stimulate dispersant action. However, large pieces of ice and slush and increased ice cover can

inhibit mixing by dampening waves. Vessels can be used to provide added energy by moving through and churning the surface ice and water. Spraying efficiency is likely to be lower than in open water because some dispersant will land on ice. Apply dispersants by air under conditions where mechanical recovery and burning are not possible and in areas deemed too unsafe for workers.

15.5.3 Solid Ice Cover on Water

The formation of solid sea ice over a spill area significantly reduces response options. However, frozen conditions can actually serve to facilitate recovery operations by providing a solid working platform over the oil and by creating natural barriers that can be used to advantage to contain and immobilize oil. Downward-growing ice can quickly encapsulate oil under ice and there will be many in- and under-ice pockets where oil can accumulate in natural depressions, providing access for recovery (Figure 15-1).

Even large spills (tens of thousands of barrels) of crude oil, underneath or on top of solid “shore-fast” ice, could be contained within hundreds of meters from the spill source, depending on under-ice currents and ice roughness. Along the Alaskan North Slope, late winter (April) under-ice storage capacities have been estimated to be as high as 400,000 barrels per km² from surveys of fast ice; early winter estimated capacities are about half as much, reflecting smoother underside ice surfaces. However, North Slope offshore waters are relatively shallow and the currents are weak. Under-ice oil retention in higher speed currents would likely be less.

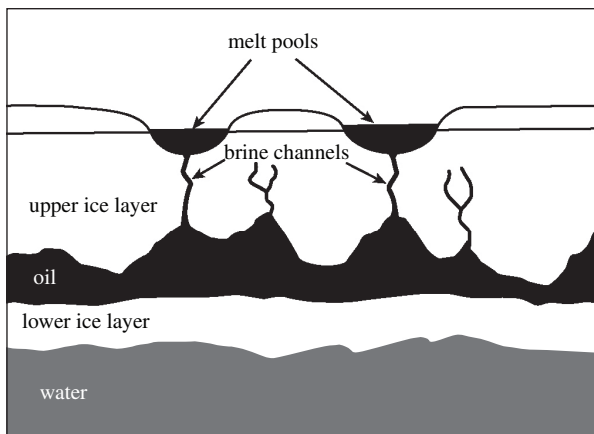

Figure 15-1 Melt Pools and Encapsulated Oil (from EPPR 1998)

15.5.3.1 Containment and Recovery

If the ice is accessible and sufficiently thick to support heavy equipment, ice can be an effective response platform, allowing a number of response options. This is especially true for frozen rivers, streams, lakes and ponds. Use mechanical graders and bulldozers to move snow into the shape of a collection dike and either freeze the snow into ice with water or cover it with an impermeable liner. Dig a trench or series of holes through the ice to reach the oil. Use rope mop skimmers, vacuums or pumps to lift the oil into the temporary storage dike until removal to more permanent storage or treatment and disposal. Cut trenches or holes using ice augers, chain saws, backhoes or a ditchwitch.

15.5.3.2 In-Situ Burning

Burning is a preferred technique for oil spilled on ice and snow-covered surfaces (See Section 15.6). If the release is under ice, then equipment (e.g., ice augers, pumps, ice-breaking vessels) can be used to provide access to it. Once oil has been exposed, it can either be burned in-situ or lifted onto ice surface for burning. Burning is an ideal way to dispose of 90+% of the oil encountered, as long as water content is not too high (maximum 25%), and the oil is of sufficient thickness (2–3 mm). Burning is also a sound approach for oil that rises through brine channels into melt pools in the ice during spring thaw.

15.5.3.3 Dispersants

Dispersants are applicable to oil under ice-cover if the currents and water exchange rates are sufficient to ensure mixing and dilution (minimum 0.5 knot current, but 1.5–3 knots preferred). Add dispersants into the below-ice oil pool or use ice-breaking vessels to bring the oil to the surface and provide mixing needed for dispersion. This could be especially effective if injection were into a steady stream of fresh oil rising from a well blowout under ice. Oil trapped in and under ice remains relatively fresh because the evaporation rates are insignificant, which should help dispersion even after a considerable period. Research is ongoing to develop new dispersant formulations that could keep the dispersants associated with oil for longer periods than presently feasible.

15.6 On Land Response Options

Response to spills on land in colder regions must consider some unique challenges compared to response in more temperate regions. Clearly, if snow and ice are present on the surface, then responders face the same issues and opportunities as for response on frozen seas, but without the challenges of moving ice and breakup periods. Many of the techniques discussed above would apply and the ice can function as an effective barrier preventing the oil from penetrating to the soil below.

Response in snow and ice conditions on land provides opportunities and limitations.

- Snow is a sorptive, porous material and will allow oil spilled on the surface to slowly flow into the snow until it solidifies in place.
- Snow covering a spill to land will be obscured unless responders are fortunate enough to be able to mark slick perimeters before or during a snow event.
- Ice is not particularly porous when oil is spilled on top of it or onto nearly-frozen soil. However, cracks in ice may provide access for spilled oil to slowly flow before it solidifies.

Main response options for spills to snow or ice on land are: mechanical recovery and in-situ burning.

- Mechanical equipment can be used to gather oiled snow and ice for burning or melting prior to oil:water recovery operations.
- Oiled snow with as much as 70% snow by weight can be burned (Figure 15-2).

Any available snow near a spill can be used to advantage by forming snow berms to help contain oil and minimize its spreading prior to removal by mechanical means. If the berm has not completely frozen, it can be lined with polyethylene sheet to fully contain the oil.

Handle spills into lakes using techniques similar to those discussed for open and frozen seas, but note the situation is more straightforward.

- Dispersant approvals are unlikely for such applications.
- If lakes are frozen, ice leads can be opened to provide access to the oil for either recovery or burning.
- The ability to deal with spills into rivers depends largely on the current.
- The principal weapon for these spills is angle booming (or inverted weirs in ice) to divert the oil into pre-determined locations with calm areas (or leads) for containment and removal.

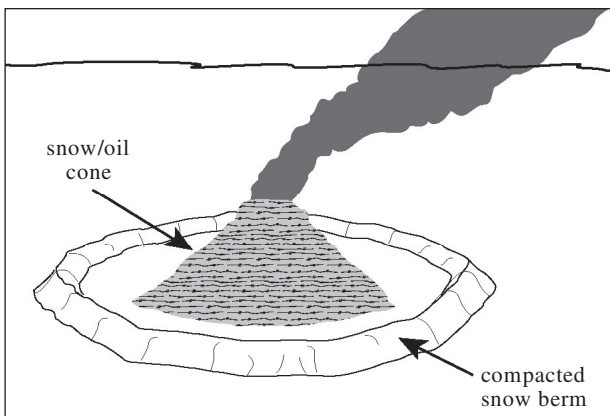

Figure 15-2 *Burning Snow Cone* (From EPPR 1998)

15.7 Assessment, Mapping, & Tracking

Use experienced specialists to map the oil's location beneath ice. Operational tools to detect or map oil in any ice type are not yet commercially available. Two techniques that hold promise for the future are a high-frequency, ground penetrating radar and an ethane gas sensor. For spills to inland waters, the most reliable means to map a slick is by boring holes in the ice to seek the oil.

- This is a time consuming endeavor and has its own safety risks.
- The current recommended practice is to drill numerous boreholes and then conduct extensive sampling to map the oil location and determine how much is present. Use markers to track the location of the spill as it moves.

Operational tools to remotely detect or map spilled oil in any ice type are not yet commercially available.

Tracking oiled ice offshore or in fast moving rivers will become a priority when active response measures are not possible. Place radio and/or satellite position buoys strategically in the oil deposition zone to monitor ice movements. Place pylons with light strobes on ice floes in the oil slick to assist aerial tracking. Conduct aerial reconnaissance using visual observations and remote sensing devices (e.g., airborne FLIR: forward-looking infrared).

15.8 Cleaning of Oiled Shorelines

Shoreline types in cold regions are not as diverse as in warmer regions. They include:

- Bedrock
- Man-made structures (e.g., drilling platforms and work islands)
- Permanently ice-covered shores
- Sand beaches
- Mixed sediment shorelines
- Pebble/cobble shorelines
- Boulders and riprap
- Scarps and cliffs
- Sand flats
- Mud flats
- Peat
- Inundated lowland tundra
- Salt marshes (not common, but important)

Techniques for cleaning these shorelines are described in Section 12.

Shorelines with high energy and/or frequent ice coverage tend to have low biological diversity and abundance. Biological activity is highest on low energy shorelines and protected pockets occurring in rocky shorelines. In most instances, the presence of ice onshore or in the adjacent near-shore water prevents oil from contacting the shoreline.

For the majority of these shorelines, natural recovery is the preferred clean-up option, except for pockets of very thick heavier oil. Remove these using the least intrusive cleaning methods summarized in Section 12.

In-situ treatment techniques, such as sediment relocation or mixing, may be preferred in remote areas where treatment is considered necessary and where the risk of re-mobilized oil affecting biological resources is low. These treatments minimize waste generation and have been shown to be effective in the acceleration of weathering and, in particular, biodegradation.

Burn pooled oil on shorelines if it is feasible and safe to do so. Oil/snow mixtures are relatively easy to remove, either manually or mechanically. Take mixtures to a heated facility for melting and separation or to a less sensitive area for storage until warm weather can make oil recovery feasible.

The most sensitive time of year for cold region shorelines is during bird migration (June through September) when high concentrations of birds land on beaches, mud flats, and marshes to feed on zooplankton, insects, larvae, and worms. Spills during or prior to this time may warrant accelerated and aggressive oil removal to protect migrating birds. If shoreline cleaning is not possible, employ bird hazing techniques to prevent birds from landing in the more heavily oiled areas (see Section 14).

Finally, peat is an excellent sorbent and is usually plentiful in colder areas. For effective cleaning, only use dried cultivated peat and not the wet peat present on the shorelines. Use oiled peat as a fuel for incineration.

15.9 Response in Permafrost Habitats

In Arctic regions and some sub-arctic regions, the average annual temperature is below 0°C (32°F) and the sub-soil remains frozen. This frozen soil, or permafrost, is typically found under treeless, lichen- and moss-covered plains called tundra. Tundra occurs where

- extreme winter cold and wind, brief cool summers, and shallow continuous permafrost prevent trees from growing.
- the softened ground above permafrost, in summer, contains fauna and flora that if disturbed could take many years and even decades to recover.

Spill response over oiled permafrost during warmer (thaw) seasons must consider the potential traffic impacts from response itself on the tundra. Aggressive response could do more long-term harm than good and the best course of action may be to allow natural recovery. However, such recovery could take a considerable length of time because of the relatively short duration of the growth season. If oil is to be removed during thaw periods, it must be done using techniques such as vacuuming and sorption that will leave the area as undisturbed as possible. In winter, surface soil above the permafrost freezes so one may use conventional land-based response techniques, such as burning, with less concern for physical disruption.

Inundated, lowland tundra habitat occurs in coastal areas which have flooded because of subsidence. Strong onshore winds can lead to flooding of these areas up to 1 meter deep and hundreds of meters inland. This creates a thriving plant and insect community that is an important resource for migrating birds. This habitat, and its communities, is very sensitive to an oil spill and to associated clean-up efforts.

- A spill occurring coincident with strong onshore winds could mean oil deposits well in-land.
- Surface sediments and peat deposits are often water saturated, which will keep spilled oil from seeping into soil. However, oil could remain for some time.
- It may be best to undertake removal only after freezing sets in to minimize damage.

Pipelines are generally not buried in a permafrost layer. If a pipeline above permafrost leaks, then it is likely any spilled oil will either solidify and stay in place (if the oil's pour point temperature is higher than the ambient temperature) or, if still fluid, will flow to some low point where it will accumulate and can eventually be recovered.

16 Aviation Support

16.1 Introduction

The value of aviation is often under-appreciated during contingency planning and response. Aviation (expertise and aircraft) can be used for strategic purposes to provide overflight and surveillance, and tactical purposes including slick targeting, equipment spotting, dispersant spraying, and sometimes for environmental monitoring. It is critical to pre-identify, evaluate, and select aerial logistical infrastructure (airport, fuel, and maintenance shops) during contingency planning.

For small spills, having support of rotary wing aircraft early in a response can maximize the efficiency of response resources. For large spills, having a good understanding of the location of spilled oil and response resources can help ensure a successful operation by providing information to decision-makers who may be far from the incident location. The process of assigning missions for overflight and surveillance, and in support of in-situ burning, mechanical recovery, and dispersant operations requires an understanding of aerial support options.

Our ExxonMobil aviation safety philosophy:

- No air operations without a daily safety briefing and pre-flight briefing form
- Establish a minimum acceptable ceiling and visibility requirements
- Situational awareness of the weather, operational requirements, obstacle data, etc.
- Posting of NOTAMs (Notice To AirMen), as needed
- Debrief of all flights at day's end and a posting of lessons learned.

The following topics will be described in this chapter:

- Use of approved aviation contractors and aircraft
- Strategic planning and coordination
- Aerial observation
- Aerial support for dispersant spray operations
- Aerial support for in-situ burn operations

16.2 Use of Approved Aviation Contractors and Aircraft

Prior to contracting or use of any aviation assets, it is generally required that a company or resource has been evaluated and recommended for use by a qualified aviation advisor or suitably qualified individual. Third-party aircraft should meet standards of safety/technical quality comparable to those of the contracting company. Industry guides are available to provide guidelines outlining minimal aircraft technical and operational specifications.

Consider the following factors when establishing any aviation contractual scope of work (not all inclusive):

- Environmental factors such as climatic conditions, altitude, temperatures, weather, topography, etc.
- Type of typical cargo
- Special equipment (emergency/oil spill response, etc.)
- Training for aircraft crews and personnel to be flown
- Medevac, and search and rescue
- Pilot duty time
- Total anticipated flying time
- Crew rotation schedules
- Airline schedules for crew changes in remote locations
- Personnel transportation frequency and numbers
- Fuel availability and location
- Available support facilities, airports, etc.
- Aircraft availability including back-up aircraft
- Duration of services
- Drug and alcohol programs in compliance with Company policy

16.3 Planning and Roles

16.3.1 Basic Aviation Services Planning

In addition to addressing safety and specific response support roles, aviation plans should address the following:

Communications:

- Frequency allocation plan prevents frequency congestion
- No unnecessary chatter on radios
- Use call signs as opposed to tail numbers
- Obtain weather forecasts and disseminate

Command and Control Structure:

- No air operations to be conducted without approval of aviation advisor or similarly empowered individual
- Coordination and scheduling of aircraft movements and operations.

The decision to use a rotary or fixed-wing aircraft is influenced by a number of factors. Although both platforms are capable of providing an overview, situational-dependent factors may make one more advantageous than the other (e.g., transit time to spill, airport availability, and requirement to stay on-station). Initially, only one type of aircraft could be available and would be used until replacement aircraft can be positioned. Table 16-1 can help make a decision between rotary and fixed-wing aircraft.

Table 16-1 Advantage and Disadvantages of Aerial Platforms

Aircraft Capability Factors	Rotary Wing	Fixed-Wing
Provides overview of locations of interest	+	+
Able to fly slow	+	-
Transit time to spill	-	+
Distance capability	-	+
Time on-station	-	+
Hold on-station (if permitted)	+	-
Level of logistical support (e.g., runway)	+	-

The use of unmanned aerial systems (UAS) is expected to increase as the availability of this technology grows. There are a number of advantages of UASs including safety (i.e., personnel not on board, operational flexibility) and generally decreased logistical requirements. UAS operators will need to meet regulatory requirements for approval to operate, pilot training, operations manual, etc. It is recommended that an aviation advisor review UAS operations.

16.3.2 Aviation Support Roles

16.3.2.1 Aviation Advisor or Air Operations Branch Director

Industry aviation advisors can assist in recommending specific aircraft types which are preferred, as well as contractors that are qualified to provide a particular service. To provide necessary additional specifications for the local area and anticipated operating plan, qualified aviation advisors should be used to technically review bid proposals as well as final bid submissions. During a response, they can assist with guidance on:

- Separation of aircraft by altitude
- Lateral separation distance
- Flight paths
- Restricted airspace

16.3.2.2 Local Aviation Contact

It is recommended that those responsible for managing a spill response should identify an individual to serve as the primary local aviation contact, who is familiar with local resources (e.g., airports, aviation assets, etc.) and state/federal regulations. The local aviation contact will provide aviation stewardship and liaise with unified command, the air operations branch director or a suitably qualified aviation advisor, and any aviation services contractors. The local aviation contact:

- Should have direct interface with the Operations section;
- Interfaces with the contract administrator for related contractual matters. The aviation contact typically approves aircraft flight schedules and the dispatch of aircraft; and
- Typically oversees local aviation operations, and passes operational, technical or safety related queries to the appropriate individual within the air operations structure (e.g., air operations branch director or a aviation advisor).

16.3.2.3 Aerial Observer

The information provided by trained observers is critical to response and as such it is important to use trained observers who have experience in identification, distribution, and quantification of spilled oil. The efficiency of mechanical recovery, in-situ burning, and dispersant application can be directly influenced by the accuracy of information from an aerial observer since it will be provided to response management or command center staff for strategic decision-making. Terminology and codes have been developed to provide a consistent manner of reporting spilled oil appearance and distribution during a response.

16.3.2.4 Spotter

It is important to use trained spotters who have experience in identification and quantification of spilled oil to help direct tactical operations. The efficiency of mechanical recovery, in-situ burning, and dispersant application can be directly influenced by the accuracy of targeting information from a spotter since it is important to focus efforts to those areas with the highest concentration of oil. Familiarity with natural conditions which may mimic appearance of spilled oil can limit the frequency of false positive and false negative identifications.

16.4 Aviation Support

Information compiled through use of aviation assets supports the tactical deployment of mechanical recovery, dispersant, and in-situ burn operations. For more complex incidents it can be prudent to conduct periodic overflights to assess slick conditions and locations. This may include flights early in the morning to confirm the movement of the spilled oil on water overnight.

16.4.1 Mechanical Recovery Operations

Aviation assets and services can be provided for spill incidents on land and on water. In many responses, mechanical recovery is the primary response option utilized due to a number of factors such as size of spill, the state of oil weathering, location, type of oil, equipment or response assets available. Depending on the size of an incident and ease of access for responders for spills on land, the use of aviation support may be beneficial to assess distribution, locations of thickest oil, and/or access points for response operations which would otherwise be unknown. For spills to surface water, aviation support may be beneficial to assess distribution and locations of thickest oil (Figure 16-1).

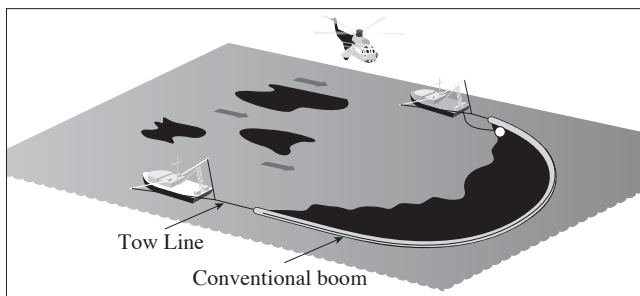

Figure 16-1 Rotary wing aircraft can provide details and guidance to operations on where the larger quantity of oil is located

16.4.2 Aviation Support of Surface Dispersant Operations

Frequently aircraft are used for oil spill dispersant spray operations. When more than one aircraft is responding, the formulation of an aviation plan is advisable. The basic plan below is a template for modification to meet local situations (Figure 16-2).

DISPERSANT MISSION PRE FLIGHT BRIEFING FORM			
The following topics should be addressed during a daily pre-flight mission briefing and included in flight packets to be given to each flight crew scheduled for duty.			
<ol style="list-style-type: none">1. Safety of flight2. Weather3. Location of activities - Latitude/Longitude4. Control Points, Routes - Latitude/Longitude5. Altitude assignments6. Frequency allocation7. Assignment of call signs8. Filing of flight plans9. Refueling locations10. Schedule of activities11. Restricted airspace12. NOTAMS			
DISPERSANT SPRAY RESOURCES			
CALL SIGN	LOCATION	CONTACT FREQ	TYPE
Spotter 1			
Spotter 2			
Spray Plane 1			
Spray Plane 2			
Air Eye 1			
Command and Control 1			
Command & Control Operations Brief @ _____ Place Entry / Exit / Hold Points			
Point	Lat/Long	Max. Altitude	
Spill Site			
Entry			
Exit			
Forward Air Observer in Spotter 1 for airborne control Altitude Assignments Appropriate Visual Flight Plans			

Figure 16-2 Sample Pre-Flight Briefing Form

Figure 16-3 illustrates a typical flight and spray path showing entry and exit control points.

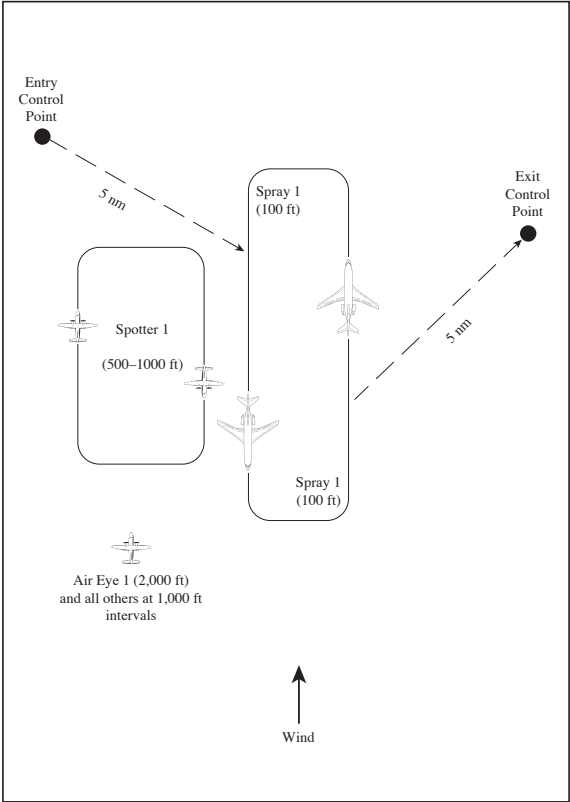

Figure 16-3 Diagram of Possible Dispersant Spray Operations to illustrate coordination and scheduling of aircraft movements and operations

16.4.3 Aviation Support for In-situ Burn Operations

Primary aerial support for in-situ burning includes targeting the slick and then to ignite the vapors of spilled oil. This section focuses on the use of a heli-torch which can be used on spilled oil on water or land (Figure 16-4).

16.4.3.1 Heli-Torch Operations:

General Considerations:

- An In-Situ Burn Operations Group Supervisor or similarly qualified individual typically has the overall responsibility for a successful burn and develops a burn plan
- The best technique is for the pilot to use vertical reference (VR) on the torch
- Use of a long line is mandatory
- Use of a bubble window or removal of the pilot window is encouraged
- Management of rotor wash is very important, as the downwash can extinguish the flames

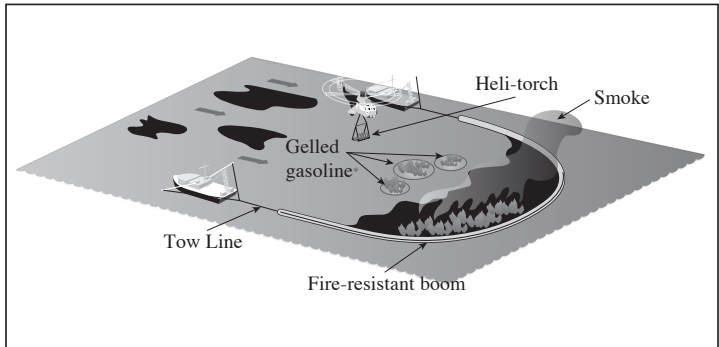

Figure 16-4 In-Situ Burn Operation using a helicopter and heli-torch

References & Websites

References

The following is a list of selected references that are widely available and which may be useful to those seeking additional information related to oil spill response. The list is not intended to be all encompassing.

Alaska Clean Seas. 2014. *Technical Manual, Volume 1—Tactics Descriptions*.

Alaska Department of Environmental Conservation (ADEC). 2005 *Tundra Treatment Guidelines*, A Manual for Treating Oil and Hazardous Substance Spills to Tundra. Division of Spill Prevention and Response. Juneau, Alaska.

American Petroleum Institute (API), National Oceanic and Atmospheric Administration (NOAA), U.S. Coast Guard, and U.S. Environmental Agency (EPA). 2001. *Environmental Considerations for Marine Oil Spill Response*. API Publication No. 4706. Regulatory and Scientific Affairs Department. Washington, D.C.

API. 2001. *Chemical Human Health Hazards Associated with Oil Spill Response*. API Publication No. 4689. Regulatory and Scientific Affairs Department. Washington, D.C.

API. 2013. *Remote Sensing in Support of Oil Spill Response*. API Technical Report 1144. 80 pp.

API, NOAA, United States Coast Guard (USCG), and EPA. 2001. *Characteristics of Response Strategies: A Guide for Spill Response Planning in Marine Environments*. Available from NOAA Office of Response and Restoration HAZMAT, Seattle, WA. June. 80 pp.

API and NOAA. 1995. *Options for Minimizing Environmental Impacts of Freshwater Spill Response*. API Publication No. 4558. Health and Environmental Sciences Department. Washington, D.C. February. 136 pp.

Aspen Publishers, *Oil Spill Intelligence Report*, published weekly, New York, N.Y.

ASTM International (formerly American Society for Testing and Materials). 1995. *The Use of Chemicals in Oil Spill Response*, Peter Lane, editor. ASTM publication code number STP 1252, West Conshohocken, PA.

ASTM. 1998. *Oil Spill Response Performance Review of Skimmers*. Prepared by R. Schulze. ASTM Manual Series MNL34. West Conshohocken, PA, 151 pp.

Bonn Agreement. 2009. *Part 2: Remote Sensing and Operational Guidelines in Bonn Agreement Aerial Operations Handbook*, 2009.

Bonn Agreement. 2009. *Part 3: Guidelines for oil Pollution Detection, Investigation and Post Flight Analysis/Evaluation for Volume Estimation in Bonn Agreement Aerial Operations Handbook*, 2009. <http://www.bonnagreement.org>

Dickins, D.F., and I. Buist, 1999. *Countermeasures for Ice Covered Waters, Pure and Applied Chemistry*, Vol. 71, No. 1, pp 173–191.

Emergency Prevention, Preparedness and Response (EPPR). 1998. *Field Guide for Oil Spill Response in Arctic Waters 1998* (prepared by E.H. Owens, L.B. Solsberg, M.R. West and M. McGrath), for the Arctic Council. Environment Canada, Yellowknife, NT, Canada, 348 pp.

Environment Canada. 2000. *The SCAT Manual. A Field Guide to the Documentation and Description of Oiled Shorelines*. 2nd Ed. Catalog No. En-40-475/2000E. Edmonton, Alberta. 108 pp.

Environment Canada. 1996. *Field Guide for the Protection and Cleanup of Oiled Arctic Shorelines*. Catalog No. En-40-519/1996E. Prairie and Northern Region. Yellowknife, NT. 213 pp.

Environment Canada. 1991. *Selection Criteria and Laboratory Evaluation of Oil Spill Sorbents, Update IV*. Report EPS 3/SP/3. 71 pp.

Exxon Biomedical Sciences, Inc. and Tri-State Bird Rescue and Research, Inc. 2010. *Oiled Bird Response Guidance for Remote Regions*.

Exxon Biomedical Sciences, Inc. and Tri-State Bird Rescue and Research, Inc. 1998. *Rehabilitation Manual for Oiled Birds*.

ExxonMobil Research and Engineering Company (EMRE). 2008. *Dispersant Guidelines*. Available from EMRE. Dispersant Guidelines.

Exxon Production Research Company. 1998. *Planning Guide for Oil Spill Response Equipment and Vessels*. Report No. EPR.2PR.98.

Fingas, M.F., Brown, C.E., and L. Gamble. 1999. *The Visibility and Detectability of Oil Slicks and Oil Discharges in Water*. Proceedings of the Twenty-Second Arctic Marine Oilspill Program Technical Seminar. Environment Canada, Ottawa, Ontario, pp 865–886.

Foget, C.R., Schrier, E., Cramer, M., and R.W. Castle. 1979. *Manual of practice for protection and cleanup of shorelines. I: Decision guide. II: Implementation guide.* Office of Research and Development, U.S. EPA, Cincinnati, OH, EPA-600/7/187 (a and b), two volumes, 283 pp.

Greer, R.D. and D.J. O'Connor. 1994. *Waterbird Deterrent Techniques. Marine Spill Response Corporation.* Technical Report Series 94-003. Available through API.

International Maritime Organization. 1995. *IMO/UNEP Guidelines on Oil Spill Dispersant Application including Environmental Considerations*, IMO, London.

The International Tanker Owners Pollution Federation Ltd. (ITOPF). 1997. *Response to Marine Oil Spills*, London, UK.

Interspill Conference Proceedings, *Session 7 on Cold Water Response*. 2004. Papers by C.K. Owens, J.V. Mullin, I. Buist, H. Jensen, P.J. Brandvik, and D. Dickins. Trondheim, Norway.

Lessard, R.R., and G. DeMarco, 2000. *The Significance of Oil Spill Dispersants*, Spill Science & Technology Bulletin, Vol. 6, No. 1, Elsevier Science Ltd., pp 59–68.

Mackay, D., Buist, I., Mascarenhas, R., and S. Paterson. 1980. *Oil Spill Processes and Models*, University of Toronto, Prepared for Environmental Emergency Branch, Environmental Impact Control Directorate, Environmental Protection Service, Ottawa, Ontario.

National Research Council (NRC). 1989. *Using Oil Spill Dispersants on the Sea*. National Academy Press. Washington D.C. 335 pp.

NRC. 2005. *Understanding Oil Spill Dispersants: Efficacy and Effects*. The National Academies Press. Washington, D.C.

NOAA. 2000. *Characteristic Coastal Habitats, Choosing Spill Response Alternatives*. Office of Response and Restoration. November. Seattle, WA.

NOAA. 2000. *Shoreline Assessment Manual*. Office of Response and Restoration. HAZMAT Report No. 2000-1. August. Seattle, WA.

NOAA. 2007. *Dispersant Application Observer Job Aid*. Office of Response and Restoration. Seattle, WA.

NOAA. 2012. *Open Water Oil Identification Job Aid for Aerial Observation*. Office of Response and Restoration. Seattle, WA.

Oil and Gas Producers (OGP). 2013. *Aircraft Management Guidelines*. Report No. 390. United Kingdom. 214 pp.

S.L. Ross. 2013. *World Catalog of Oil Spill Response Products, 10th Edition*. S.L. Ross Environmental Research Ltd., Ottawa, Ontario, Canada.

United States Coast Guard (USCG). 2001. *Oil Spill Response in Fast Currents, A Field Guide*. U.S. Coast Guard Research and Development Center. Report No. CG-D-01-02. Washington, D.C.

U.S. Fish and Wildlife Service. 2003. *Best Practices for Migratory Bird Care During Oil Spill Response*. Division of Environmental Quality. Arlington, VA.

Websites

The following is a list of selected websites which may be useful to those seeking additional information related to oil spill response.

API. Oil Spill Prevention & Response. <http://www.spillprevention.org>.

- Joint Industry Task Force Reports.
<http://www.spillprevention.org/apijitfreports.html>.

Arctic Response Technology Joint Industry Program.
<http://www.arcticresponsetechnology.org>.

ARPEL (Regional Association of Oil, Gas and Biofuels Sector Companies in Latin America and the Caribbean). <http://www.arpel.org>.

ASTM. Committee F20 on Hazardous Substances and Oil Spill Response.
<http://www.astm.org/COMMITTEE/F20.htm>.

Australian Marine Oil Spill Centre Pty Ltd. (AMOSC). <http://www.amosc.com.au>.

Bureau of Safety and Environmental Enforcement (BSEE) – Oil Spill Response Research. <http://www.bsee.gov/Research-and-Training/Oil-Spill-Response-Research/index/>.

Center of Documentation, Research, and Experimentation on Accidental Water Pollution (CEDRE). <http://www.cedre.fr/index-en.php>.

Clean-up Oil.com. The International Directory of Oil Spill Contractors.
<http://www.cleanupoil.com>.

Environment Canada. Environmental Emergencies. <https://www.ec.gc.ca/ee-ue>.

EPA. Emergency Management. <http://www.epa.gov/oilspill>.

- National Oil and Hazardous Substances Pollution Contingency Plan (NCP) Product Schedule – Subpart J. <http://www.epa.gov/emergencies/content/ncp/index.htm>.
- Freshwater Spills Symposia. <http://www.epa.gov/emergencies/content/fss/index.htm>.

International Oil Spill Conference (IOSC) Proceedings. <http://ioscproceedings.org>.

Interspillage Conference Proceedings. <http://www.interspillage.com>.

APIECA. Oil Spill Preparedness and Response Report Series.
<http://www.ipieca.org>.

Topics:

1. Biological Impacts of Oil Pollution: Mangroves
 2. Biological Impacts of Oil Pollution: Saltmarshes
 3. Biological Impacts of Oil Pollution: Rocky Shores
 4. Biological Impacts of Oil Pollution: Fisheries
 5. Biological Impacts of Oil Pollution: Sedimentary Shores
 6. Choosing Spill Response Options to Minimize Damage: Net Environmental Benefit Analysis
 7. Guidelines for Oil Spill Waste Minimization and Management
 8. A Guide to Oiled Wildlife Response Planning
 9. Sensitivity Mapping for Oil Spill Response
 10. Dispersants and Their Role in Oil Spill Response
- Additional Oil Spill Good Practice guides are being developed.

National Institute for Occupational Health and Safety (NIOSH).
<http://www.cdc.gov/niosh/>.

NOAA. Office of Response and Restoration. <http://response.restoration.noaa.gov>.

- Responder Tools. <http://response.restoration.noaa.gov/oil-and-chemical-spills/chemical-spills/response-tools/guide-responder-tools.html>.
- Job Aids. <http://response.restoration.noaa.gov/oil-and-chemical-spills/oil-spills/resources/job-aids-spill-response.html>.

Occupational Safety & Health Administration (OSHA). <https://www.osha.gov>.

OHMSETT – National Oil Spill Response Research Facility.
<http://www.ohmsett.com>.

Pipeline and Hazardous Materials Safety Administration (PHMSA).
<http://phmsa.dot.gov/hazmat>.

The International Tanker Owners Pollution Federation Ltd. (ITOPF). 2012.
Technical Information Papers (TIPS). ITOPF. London, UK. <http://www.itopf.com>.

Topics:

1. Aerial observation of marine oil spills
2. Fate of marine oil spills
3. Use of booms in oil pollution response
4. Use of dispersants to treat oil spills
5. Use of skimmers in oil pollution response
6. Recognition of oil on shorelines
7. Clean-up of oil from shorelines
8. Use of sorbent materials in oil spill response
9. Disposal of oil and debris
10. Leadership, command & management of oil spills
11. Effects of oil pollution on fisheries and mariculture
12. Effects of oil pollution on social and economic activities
13. Effects of oil pollution on the marine environment
14. Sampling and monitoring of marine oil spills
15. Preparation and submission of claims from oil pollution
16. Contingency planning for marine oil spills
17. Response to marine chemical incidents

USCG. National Response Center. <http://www.nrc.uscg.mil>.

USCG. Research, Development, Test and Evaluation: Research and Development Center. <http://www.uscg.mil/hq/cg9/rdc/rdc.asp>.

RESTRICTION TO USE

Material may be copied in whole or in part without the express authorization of ExxonMobil provided that: (1) the user includes ExxonMobil's copyright notice on all copies, (2) the materials are in no way modified or used in any misleading or inappropriate manner, and (3) the materials are not sold or in any way exploited.

English Conversion Factors

Volume	Flow Rate
1 yd ³ = 27 ft ³ = 46,656 in ³ 1 gallon liquid US = 0.134 ft ³ = 231 in ³ 1 gallon British = 1.2 gallon liquid US 1 API barrel = 42 gallon liquid US	1 gpm = 0.0167 gps (gal/sec) = 60 gal/hr = 1,440 gal/day 1 gpm = 0.00223 cfs (ft ³ /sec) 1 gpm = 34.3 API bbl/day
Length	Velocity
1 ft = 0.333 yd = 12 in 1 fathom (US) = 6 ft 1 mile (US) = 8 Furlong = 660 ft 1 mile (US) = 320 Rod = 5,280 ft 1 mile (US) = 0.87 Nautical Mile (NM)	1 knot = 1 NM/hr 1 knot = 1.15 mph (US) 1 knot = 1.69 ft/sec 1 knot = 6,080 ft/hr 1 mph = 88 ft/min = 1.47 ft/sec
Area	Mass/Weight
1 yd ² = 9 ft ² = 1,296 in ² 1 acre = 43,560 ft ² = 4,840 yd ² 1 sq mile = 640 acre 1 ton (short) = 2,000 lb	1 slug = 32.17 lb 1 lb = 16 oz 1 long ton = 1.12 ton
Surface Tension	Force
1 lb/ft = 0.0833 lb/in	1 lb (force) = 32.17 poundal
Pressure	Application Rates
1 atm = 406.8 inch of water 1 atm = 14.70 lb/in ² = 2,116 lb/ft ² 1 lb/in ² = 27.68 inch of water 1 lb/in ² = 144 lb/ft ²	1 gal/ft ² = 1.604 in. thick 1 gal/ft ² = 1,037 API bbl/acre
Miscellaneous	
storage volume for boom, volume/length: ft ³ /ft x 0.093 = m ³ /m mg/L = parts per million (ppm) = % x 10 ⁻² x 10 ⁶ = ppm (example: 0.7% oil content; 0.007 x 10 ⁶ = 7,000 ppm) water density = 62.4 lb/ft ³ = 8.34 lb/gal viscosity in centipoise (cp) = viscosity in centistokes (cSt) x density temperature Fahrenheit = (temperature Centigrade x 1.8) + 32	

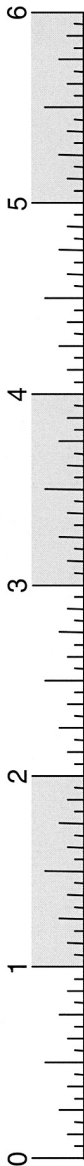

ExxonMobil